



# "RDNA 2" Instruction Set Architecture

## *Reference Guide*

AMD

30-November-2020

## Specification Agreement

This Specification Agreement (this "Agreement") is a legal agreement between Advanced Micro Devices, Inc. ("AMD") and "You" as the recipient of the attached AMD Specification (the "Specification"). If you are accessing the Specification as part of your performance of work for another party, you acknowledge that you have authority to bind such party to the terms and conditions of this Agreement. If you accessed the Specification by any means or otherwise use or provide Feedback (defined below) on the Specification, You agree to the terms and conditions set forth in this Agreement. If You do not agree to the terms and conditions set forth in this Agreement, you are not licensed to use the Specification; do not use, access or provide Feedback about the Specification. In consideration of Your use or access of the Specification (in whole or in part), the receipt and sufficiency of which are acknowledged, You agree as follows:

1. You may review the Specification only (a) as a reference to assist You in planning and designing Your product, service or technology ("Product") to interface with an AMD product in compliance with the requirements as set forth in the Specification and (b) to provide Feedback about the information disclosed in the Specification to AMD.
2. Except as expressly set forth in Paragraph 1, all rights in and to the Specification are retained by AMD. This Agreement does not give You any rights under any AMD patents, copyrights, trademarks or other intellectual property rights. You may not (i) duplicate any part of the Specification; (ii) remove this Agreement or any notices from the Specification, or (iii) give any part of the Specification, or assign or otherwise provide Your rights under this Agreement, to anyone else.
3. The Specification may contain preliminary information, errors, or inaccuracies, or may not include certain necessary information. Additionally, AMD reserves the right to discontinue or make changes to the Specification and its products at any time without notice. The Specification is provided entirely "AS IS." AMD MAKES NO WARRANTY OF ANY KIND AND DISCLAIMS ALL EXPRESS, IMPLIED AND STATUTORY WARRANTIES, INCLUDING BUT NOT LIMITED TO IMPLIED WARRANTIES OF MERCHANTABILITY, FITNESS FOR A PARTICULAR PURPOSE, NONINFRINGEMENT, TITLE OR THOSE WARRANTIES ARISING AS A COURSE OF DEALING OR CUSTOM OF TRADE. AMD SHALL NOT BE LIABLE FOR DIRECT, INDIRECT, CONSEQUENTIAL, SPECIAL, INCIDENTAL, PUNITIVE OR EXEMPLARY DAMAGES OF ANY KIND (INCLUDING LOSS OF BUSINESS, LOSS OF INFORMATION OR DATA, LOST PROFITS, LOSS OF CAPITAL, LOSS OF GOODWILL) REGARDLESS OF THE FORM OF ACTION WHETHER IN CONTRACT, TORT (INCLUDING NEGLIGENCE) AND STRICT PRODUCT LIABILITY OR OTHERWISE, EVEN IF ADVISED OF THE POSSIBILITY OF SUCH DAMAGES.
4. Furthermore, AMD's products are not designed, intended, authorized or warranted for use as components in systems intended for surgical implant into the body, or in other applications intended to support or sustain life, or in any other application in which the failure of AMD's product could create a situation where personal injury, death, or severe property or environmental damage may occur.
5. You have no obligation to give AMD any suggestions, comments or feedback ("Feedback") relating to the Specification. However, any Feedback You voluntarily provide may be used by AMD without restriction, fee or obligation of confidentiality. Accordingly, if You do give AMD Feedback on any version of the Specification, You agree AMD may freely use, reproduce, license, distribute, and otherwise commercialize Your Feedback in any product, as well as has the right to sublicense third parties to do the same. Further, You will not give AMD any Feedback that You may have reason to believe is (i) subject to any patent, copyright or other intellectual property claim or right of any third party; or (ii) subject to license terms which seek to require any product or intellectual property incorporating or derived from Feedback or any Product or other AMD intellectual property to be licensed to or otherwise provided to any third party.
6. You shall adhere to all applicable U.S., European, and other export laws, including but not limited to the U.S. Export Administration Regulations ("EAR"), (15 C.F.R. Sections 730 through 774), and E.U. Council Regulation (EC) No 428/2009 of 5 May 2009. Further, pursuant to Section 740.6 of the EAR, You hereby certifies that, except pursuant to a license granted by the United States Department of Commerce Bureau of Industry and Security or as otherwise permitted pursuant to a License Exception under the U.S. Export Administration Regulations ("EAR"), You will not (1) export, re-export or release to a national of a country in Country Groups D:1, E:1 or E:2 any restricted technology, software, or source code You receive hereunder, or (2) export to Country Groups D:1, E:1 or E:2 the direct product of such technology or software, if such foreign produced direct product is subject to national security controls as identified on the Commerce Control List (currently found in Supplement 1 to Part 774 of EAR). For the most current Country Group listings, or for additional

information about the EAR or Your obligations under those regulations, please refer to the U.S. Bureau of Industry and Security's website at <http://www.bis.doc.gov/>.

7. If You are a part of the U.S. Government, then the Specification is provided with "RESTRICTED RIGHTS" as set forth in subparagraphs (c) (1) and (2) of the Commercial Computer Software-Restricted Rights clause at FAR 52.227-14 or subparagraph (c) (1)(ii) of the Rights in Technical Data and Computer Software clause at DFARS 252.277-7013, as applicable.
8. This Agreement is governed by the laws of the State of California without regard to its choice of law principles. Any dispute involving it must be brought in a court having jurisdiction of such dispute in Santa Clara County, California, and You waive any defenses and rights allowing the dispute to be litigated elsewhere. If any part of this agreement is unenforceable, it will be considered modified to the extent necessary to make it enforceable, and the remainder shall continue in effect. The failure of AMD to enforce any rights granted hereunder or to take action against You in the event of any breach hereunder shall not be deemed a waiver by AMD as to subsequent enforcement of rights or subsequent actions in the event of future breaches. This Agreement is the entire agreement between You and AMD concerning the Specification; it may be changed only by a written document signed by both You and an authorized representative of AMD.

## DISCLAIMER

The information contained herein is for informational purposes only, and is subject to change without notice. This document may contain technical inaccuracies, omissions and typographical errors, and AMD is under no obligation to update or otherwise correct this information. Advanced Micro Devices, Inc. makes no representations or warranties with respect to the accuracy or completeness of the contents of this document, and assumes no liability of any kind, including the implied warranties of noninfringement, merchantability or fitness for particular purposes, with respect to the operation or use of AMD hardware, software or other products described herein. No license, including implied or arising by estoppel, to any intellectual property rights is granted by this document. Terms and limitations applicable to the purchase or use of AMD's products or technology are as set forth in a signed agreement between the parties or in AMD's Standard Terms and Conditions of Sale.

AMD, the AMD Arrow logo, and combinations thereof are trademarks of Advanced Micro Devices, Inc. OpenCL is a trademark of Apple Inc. used by permission by Khronos Group, Inc. OpenGL® and the oval logo are trademarks or registered trademarks of Hewlett Packard Enterprise in the United States and/or other countries worldwide. DirectX is a registered trademark of Microsoft Corporation in the US and other jurisdictions. Other product names used in this publication are for identification purposes only and may be trademarks of their respective companies.

© 2018-2020 Advanced Micro Devices, Inc. All rights reserved.



**Advanced Micro Devices, Inc.**  
2485 Augustine Drive  
Santa Clara, CA, 95054  
[www.amd.com](http://www.amd.com)

# Contents

Preface	1
About This Document	1
Audience	1
Organization	1
Conventions	2
Related Documents	2
Feature Changes in RDNA2 Devices	2
Instruction Changes	3
Additional Information	3
1. Introduction	4
1.1. Terminology	5
2. Program Organization	7
2.1. Wave32 and Wave64	7
2.2. Compute Shaders	8
2.3. Data Sharing	8
2.3.1. Local Data Share (LDS)	9
2.3.2. Global Data Share (GDS)	10
2.4. Device Memory	10
2.5. Shader Padding Requirement	11
3. Kernel State	12
3.1. State Overview	12
3.2. Program Counter (PC)	13
3.3. EXECute Mask	13
3.4. Status registers	14
3.5. Mode register	15
3.6. GPRs and LDS	16
3.6.1. Out-of-Range behavior	16
3.6.2. SGPR Allocation and storage	17
3.6.3. SGPR Alignment	18
3.6.4. VGPR Allocation and Alignment	18
3.6.5. Wave Shared VGPRs	18
3.6.6. LDS Allocation and Clamping	18
3.7. M# Memory Descriptor	18
3.8. SCC: Scalar Condition code	19
3.9. Vector Compares: VCC and VCCZ	19
3.10. Trap and Exception registers	20
3.10.1. Trap Status register	21
3.11. Memory Violations	22
3.12. Initial Wave State	22
3.12.1. State Registers	23

3.12.2. SGPR Initialization	23
4. Program Flow Control	26
4.1. Program Control	26
4.1.1. Instruction Clauses	26
4.2. Branching	27
4.2.1. Subvector Execution	27
4.3. Workgroups	29
4.4. Data Dependency Resolution	29
4.5. Manually Inserted Wait States (NOPs)	30
5. Scalar ALU Operations	31
5.1. SALU Instruction Formats	31
5.2. Scalar ALU Operands	32
5.3. Scalar Condition Code (SCC)	33
5.4. Integer Arithmetic Instructions	34
5.5. Conditional Instructions	34
5.6. Comparison Instructions	35
5.7. Bit-Wise Instructions	35
5.8. Access Instructions	37
6. Vector ALU Operations	40
6.1. Microcode Encodings	40
6.2. Operands	41
6.2.1. Instruction Inputs	42
6.2.2. Instruction Outputs	43
6.2.3. Wave64 use of SGPRs	44
6.2.4. Wave64 Destination Restrictions	44
6.2.5. OPSEL Field Restrictions	44
6.2.6. Out-of-Range GPRs	45
6.3. Instructions	45
6.4. Denormalized and Rounding Modes	47
6.5. ALU Clamp Bit Usage	48
6.6. VGPR Indexing	48
6.7. Packed Math	48
6.8. Sub-Dword Addressing (SDWA)	49
6.9. Data Parallel Processing (DPP)	49
6.10. PERMLANE Specific Rules	50
7. Scalar Memory Operations	51
7.1. Microcode Encoding	51
7.2. Operations	51
7.2.1. S_LOAD_DWORD	52
7.2.2. S_DCACHE_INV	53
7.2.3. S_MEMREALTIME	53
7.3. Dependency Checking	53

7.4. Scalar Memory Clauses and Groups	53
7.5. Alignment and Bounds Checking	54
8. Vector Memory Operations	55
8.1. Vector Memory Buffer Instructions	55
8.1.1. Simplified Buffer Addressing	56
8.1.2. Buffer Instructions	56
8.1.3. VGPR Usage	58
8.1.4. Buffer Data	58
8.1.5. Buffer Addressing	59
8.1.6. 16-bit Memory Operations	64
8.1.7. Alignment	64
8.1.8. Buffer Resource	64
8.1.9. Memory Buffer Load to LDS	65
8.1.10. GLC, DLC and SLC Bits Explained	66
8.2. Vector Memory (VM) Image Instructions	67
8.2.1. Image Instructions	68
8.2.2. Image Non-Sequential Address (NSA)	70
8.2.3. Image Opcodes with No Sampler	71
8.2.4. Image Opcodes with a Sampler	71
8.2.5. VGPR Usage	73
8.2.6. Image Resource	75
8.2.7. Image Sampler	76
8.2.8. Data Formats	78
8.2.9. Vector Memory Instruction Data Dependencies	79
8.2.10. Ray Tracing	80
9. Flat Memory Instructions	83
9.1. Flat Memory Instruction	83
9.2. Instructions	85
9.2.1. Ordering	86
9.2.2. Important Timing Consideration	86
9.3. Addressing	86
9.3.1. Legal Addressing Combinations	86
9.4. Global	87
9.5. Scratch	87
9.6. Memory Error Checking	88
9.7. Data	88
9.8. Scratch Space (Private)	88
10. Data Share Operations	90
10.1. Overview	90
10.2. Dataflow in Memory Hierarchy	91
10.3. LDS Modes and Allocation: CU vs. WGP Mode	91
10.4. LDS Access	92

10.4.1. LDS Direct Reads	92
10.4.2. LDS Parameter Reads	93
10.4.3. Data Share Indexed and Atomic Access	94
10.4.4. LDS Lane-permute Ops	96
10.5. Global Data Share	97
11. Exporting Pixel and Vertex Data	98
11.1. Microcode Encoding	98
11.2. Operations	99
11.2.1. Pixel Shader Exports	99
11.2.2. Vertex Shader Exports	99
11.3. Primitive Shader Exports	100
11.4. Dependency Checking	100
12. Instructions	101
12.1. SOP2 Instructions	101
12.2. SOPK Instructions	106
12.3. SOP1 Instructions	111
12.4. SOPC Instructions	122
12.5. SOPP Instructions	123
12.5.1. Send Message	129
12.6. SMEM Instructions	130
12.7. VOP2 Instructions	130
12.7.1. VOP2 using VOP3 encoding	137
12.8. VOP1 Instructions	137
12.8.1. VOP1 using VOP3 encoding	150
12.9. VOPC Instructions	150
12.9.1. VOPC using VOP3A encoding	162
12.10. VOP3P Instructions	162
12.11. VINTERP Instructions	166
12.11.1. VINTERP using VOP3 encoding	166
12.12. VOP3A & VOP3B Instructions	167
12.13. LDS & GDS Instructions	188
12.13.1. DS_SWIZZLE_B32 Details	207
12.13.2. LDS Instruction Limitations	209
12.14. MUBUF Instructions	209
12.15. MTBUF Instructions	215
12.16. MIMG Instructions	216
12.17. EXPORT Instructions	223
12.18. FLAT, Scratch and Global Instructions	224
12.18.1. Flat Instructions	224
12.18.2. Scratch Instructions	228
12.18.3. Global Instructions	229
12.19. Instruction Limitations	234

12.19.1. DPP	234
12.19.2. SDWA	235
13. Microcode Formats	236
13.1. Scalar ALU and Control Formats	237
13.1.1. SOP2	238
13.1.2. SOPK	240
13.1.3. SOP1	241
13.1.4. SOPC	243
13.1.5. SOPP	245
13.2. Scalar Memory Format	246
13.2.1. SMEM	246
13.3. Vector ALU Formats	247
13.3.1. VOP2	247
13.3.2. VOP1	249
13.3.3. VOPC	252
13.3.4. VOP3A	257
13.3.5. VOP3B	260
13.3.6. VOP3P	263
13.3.7. SDWA	265
13.3.8. SDWAB	266
13.3.9. DPP16	267
13.3.10. DPP8	268
13.4. Vector Parameter Interpolation Format	269
13.4.1. VINTRP	269
13.5. LDS and GDS format	270
13.5.1. DS	270
13.6. Vector Memory Buffer Formats	272
13.6.1. MTBUF	272
13.6.2. MUBUF	274
13.7. Vector Memory Image Format	276
13.7.1. MIMG	276
13.8. Flat Formats	279
13.8.1. FLAT	279
13.8.2. GLOBAL	281
13.8.3. SCRATCH	282
13.9. Export Format	282
13.9.1. EXP	282



# Preface

## About This Document

This document describes the current environment, organization and program state of AMD "RDNA" Generation devices. It details the instruction set and the microcode formats native to this family of processors that are accessible to programmers and compilers.

The document specifies the instructions (include the format of each type of instruction) and the relevant program state (including how the program state interacts with the instructions). Some instruction fields are mutually dependent; not all possible settings for all fields are legal. This document specifies the valid combinations.

The main purposes of this document are to:

1. Specify the language constructs and behavior, including the organization of each type of instruction in both text syntax and binary format.
2. Provide a reference of instruction operation that compiler writers can use to maximize performance of the processor.

## Audience

This document is intended for programmers writing application and system software, including operating systems, compilers, loaders, linkers, device drivers, and system utilities. It assumes that programmers are writing compute-intensive parallel applications (streaming applications) and assumes an understanding of requisite programming practices.

## Organization

This document begins with an overview of the AMD RDNA processors' hardware and programming environment (Chapter 1).

Chapter 2 describes the organization of RDNA programs.

Chapter 3 describes the program state that is maintained.

Chapter 4 describes the program flow.

Chapter 5 describes the scalar ALU operations.

Chapter 6 describes the vector ALU operations.

Chapter 7 describes the scalar memory operations.

Chapter 8 describes the vector memory operations.

Chapter 9 provides information about the flat memory instructions.

Chapter 10 describes the data share operations.

Chapter 11 describes exporting the parameters of pixel color and vertex shaders.

Chapter 12 describes instruction details, first by the microcode format to which they belong,

then in alphabetic order.

Finally, Chapter 13 provides a detailed specification of each microcode format.

## Conventions

The following conventions are used in this document:

mono-spaced font	A filename, file path or code.
*	Any number of alphanumeric characters in the name of a code format, parameter, or instruction.
< >	Angle brackets denote streams.
[1,2)	A range that includes the left-most value (in this case, 1), but excludes the right-most value (in this case, 2).
[1,2]	A range that includes both the left-most and right-most values.
{x   y}	One of the multiple options listed. In this case, X or Y.
0.0	A single-precision (32-bit) floating-point value.
1011b	A binary value, in this example a 4-bit value.
7:4	A bit range, from bit 7 to bit 4, inclusive. The high-order bit is shown first.
<i>italicized word or phrase</i>	The first use of a term or concept basic to the understanding of stream computing.

## Related Documents

- Intermediate Language (IL) Reference Manual. Published by AMD.
- AMD Accelerated Parallel Processing OpenCL™ Programming Guide. Published by AMD.
- The OpenCL™ Specification. Published by Khronos Group. Aaftab Munshi, editor.
- OpenGL® Programming Guide, at <http://www.khronos.org/registry/OpenGL/Spec/4.5-core-profile-201608/>
- Microsoft DirectX® Reference Website, at [https://msdn.microsoft.com/en-us/library/windows/desktop/ee663274\(v=vs.85\).aspx](https://msdn.microsoft.com/en-us/library/windows/desktop/ee663274(v=vs.85).aspx)

## Feature Changes in RDNA2 Devices

This section highlights some notable changes:

- Ray Tracing
- Dot product ALU operations added accelerate inferencing and deep-learning:
  - V\_DOT2\_F32\_F16 / V\_DOT2C\_F32\_F16
  - V\_DOT2\_I32\_I16 / V\_DOT2\_U32\_U16
  - V\_DOT4\_I32\_I8 / V\_DOT4C\_I32\_I8

- V\_DOT4\_U32\_U8
- V\_DOT8\_I32\_I4
- V\_DOT8\_U32\_U4
- Image Load MSAA
- Global memory loads with "Add-TID"
- Atomic clamped subtract buffer and global instructions
- VGPR & LDS allocation-unit size doubled
- S\_MEMTIME replaced by "s\_getreg\_b32 Sn, SHADER\_CYCLES"

## Instruction Changes

Removed:

- V\_MAC\_LEGACY\_F32 (replaced by V\_FMAC\_LEGACY\_F32)
- V\_MAD\_LEGACY\_F32 (replaced by V\_FMA\_LEGACY\_F32)
- V\_MAC\_F32, V\_MADMK\_F32, V\_MADAK\_F32 (replaced by FMA equivalents)

## Additional Information

For more information on AMD GPU architectures please visit <https://GPUOpen.com>

# Chapter 1. Introduction

The AMD RDNA processor implements a parallel micro-architecture that provides an excellent platform not only for computer graphics applications but also for general-purpose data parallel applications. Data-intensive applications that require high bandwidth or are computationally intensive may be run on an AMD RDNA processor.

The figure below shows a block diagram of the AMD RDNA Generation series processors

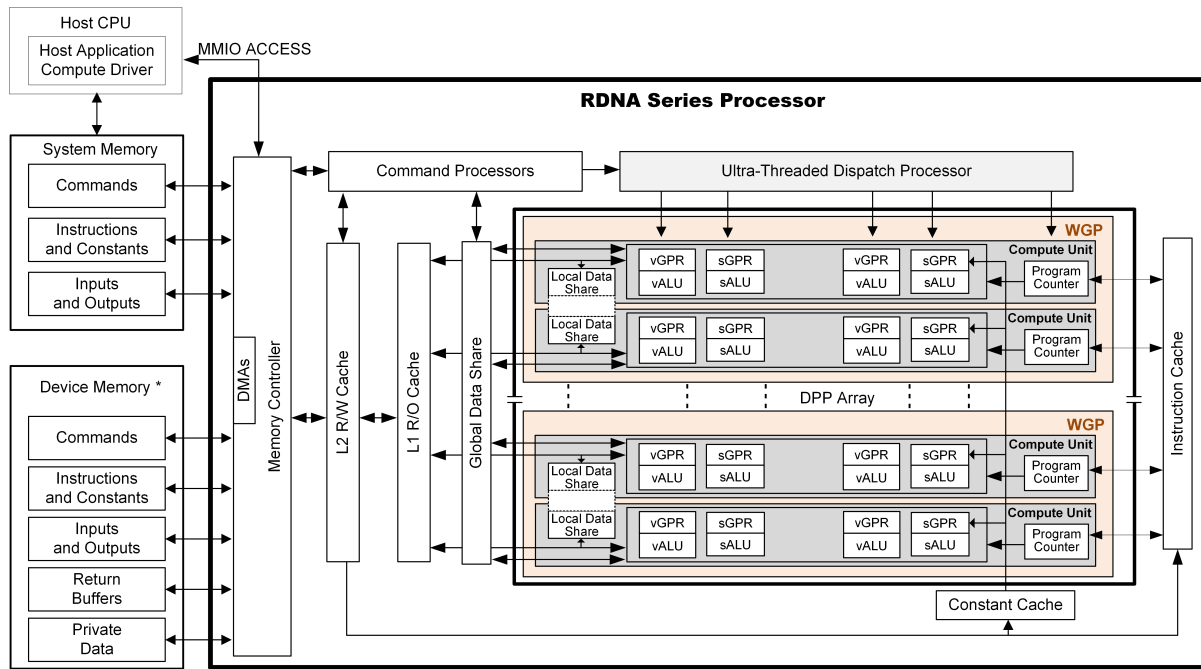

\*Discrete GPU – Physical Device Memory; APU – Region of system for GPU direct access

Figure 1. AMD RDNA Generation Series Block Diagram

The RDNA device includes a data-parallel processor (DPP) array, a command processor, a memory controller, and other logic (not shown). The RDNA command processor reads commands that the host has written to memory-mapped RDNA registers in the system-memory address space. The command processor sends hardware-generated interrupts to the host when the command is completed. The RDNA memory controller has direct access to all RDNA device memory and the host-specified areas of system memory. To satisfy read and write requests, the memory controller performs the functions of a direct-memory access (DMA) controller, including computing memory-address offsets based on the format of the requested data in memory. In the RDNA environment, a complete application includes two parts:

- a program running on the host processor, and
- programs, called kernels, running on the RDNA processor.

The RDNA programs are controlled by host commands that

- set RDNA internal base-address and other configuration registers,

- specify the data domain on which the RDNA GPU is to operate,
- invalidate and flush caches on the RDNA GPU, and
- cause the RDNA GPU to begin execution of a program.

The RDNA driver program runs on the host.

The DPP array is the heart of the RDNA processor. The array is organized as a set of **workgroup processor** pipelines, each independent from the others, that operate in parallel on streams of floating-point or integer data. The workgroup processor pipelines can process data or, through the memory controller, transfer data to, or from, memory. Computation in a workgroup processor pipeline can be made conditional. Outputs written to memory can also be made conditional.

When it receives a request, the workgroup processor pipeline loads instructions and data from memory, begins execution, and continues until the end of the kernel. As kernels are running, the RDNA hardware is designed to automatically fetch instructions from memory into on-chip caches; RDNA software plays no role in this. RDNA kernels can load data from off-chip memory into on-chip general-purpose registers (GPRs) and caches.

The AMD RDNA devices can detect floating point exceptions and can generate interrupts. In particular, they detect IEEE-754 floating-point exceptions in hardware; these can be recorded for post-execution analysis. The software interrupts shown in the previous figure from the command processor to the host represent hardware-generated interrupts for signaling command-completion and related management functions.

The RDNA processor hides memory latency by keeping track of potentially hundreds of work-items in various stages of execution, and by overlapping compute operations with memory-access operations.

## 1.1. Terminology

*Table 1. Basic Terms*

Term	Description
RDNA Processor	The RDNA shader processor is a scalar and vector ALU designed to run complex programs on behalf of a wavefront.
Dispatch	A dispatch launches a 1D, 2D, or 3D grid of work to the RDNA processor array.
Workgroup	A workgroup is a collection of wavefronts that have the ability to synchronize with each other quickly; they also can share data through the Local Data Share.
Wavefront	A collection of 32 or 64 work-items that execute in parallel on a single RDNA processor.
Work-item	A single element of work: one element from the dispatch grid, or in graphics a pixel or vertex.
Literal Constant	A 32-bit integer or float constant that is placed in the instruction stream.
Scalar ALU (SALU)	The scalar ALU operates on one value per wavefront and manages all control flow.

Term	Description
Vector ALU (VALU)	The vector ALU maintains Vector GPRs that are unique for each work item and execute arithmetic operations uniquely on each work-item.
Workgroup Processor (WGP)	The basic unit of shader computation hardware, including scalar & vector ALU's and memory, as well as LDS and scalar caches.
Compute Unit (CU)	One half of a WGP. Contains 2 SIMD32's which share one path to memory.
Microcode format	The microcode format describes the bit patterns used to encode instructions. Each instruction is either 32 or more bits, in units of 32-bits.
Instruction	An instruction is the basic unit of the kernel. Instructions include: vector ALU, scalar ALU, memory transfer, and control flow operations.
Quad	A quad is a 2x2 group of screen-aligned pixels. This is relevant for sampling texture maps.
Texture Sampler (S#)	A texture sampler is a 128-bit entity that describes how the vector memory system reads and samples (filters) a texture map.
Texture Resource (T#)	A texture resource descriptor describes an image in memory: address, data format, width, height, depth, etc.
Buffer Resource (V#)	A buffer resource descriptor describes a buffer in memory: address, data format, stride, etc.
UTC	Universal (Address) Translation Cache : used for virtual memory translating logical to physical addresses.

## Chapter 2. Program Organization

RDNA kernels are programs executed by the RDNA processor. Conceptually, the kernel is executed independently on every work-item, but in reality the RDNA processor groups 32 or 64 work-items into a wavefront, which executes the kernel on all 32 or 64 work-items in one pass.

The RDNA processor consists of:

- A scalar ALU, which operates on one value per wavefront (common to all work items).
- A vector ALU, which operates on unique values per work-item.
- Local data storage, which allows work-items within a workgroup to communicate and share data.
- Scalar memory, which can transfer data between SGPRs and memory through a cache.
- Vector memory, which can transfer data between VGPRs and memory, including sampling texture maps.

All kernel control flow is handled using scalar ALU instructions. This includes if/else, branches and looping. Scalar ALU (SALU) and memory instructions work on an entire wavefront and operate on up to two SGPRs, as well as literal constants.

Vector memory and ALU instructions operate on all work-items in the wavefront at one time. In order to support branching and conditional execute, every wavefront has an EXECute mask that determines which work-items are active at that moment, and which are dormant. Active work-items execute the vector instruction, and dormant ones treat the instruction as a NOP. The EXEC mask can be changed at any time by Scalar ALU instructions.

Vector ALU instructions can take up to three arguments, which can come from VGPRs, SGPRs, or literal constants that are part of the instruction stream. They operate on all work-items enabled by the EXEC mask. Vector compare and add with- carryout return a bit-per-work-item mask back to the SGPRs to indicate, per work-item, which had a "true" result from the compare or generated a carry-out.

Vector memory instructions transfer data between VGPRs and memory. Each work-item supplies its own memory address and supplies or receives unique data. These instructions are also subject to the EXEC mask.

### 2.1. Wave32 and Wave64

The shader hardware is designed to support both wavefronts of 32 workitems ("wave32") and wavefronts of 64 workitems ("wave64"). Both wave sizes are supported for all operations, but shader programs must be compiled for a particular wave size. The underlying hardware is primarily natively wave32, and wave64 vector ALU and memory operations are executed by issuing the instruction twice: once for the low 32 workitems, and then again for the high 32 workitems. Either half of the execution of a wave64 may be skipped if there is no work to do for

that half (i.e. EXEC == 0 for that half). Wave64 VALU instructions which return a scalar (SGPR or VCC) value do not skip either pass. Wave64 Vector Memory instructions can skip either pass, but do not skip both passes.

The upper half of EXEC and VCC are ignored for wave32 waves.

## 2.2. Compute Shaders

Compute kernels (shaders) are generic programs that can run on the RDNA processor, taking data from memory, processing it, and writing results back to memory. Compute kernels are created by a dispatch, which causes the RDNA processors to run the kernel over all of the work-items in a 1D, 2D, or 3D grid of data. The RDNA processor walks through this grid and generates wavefronts, which then run the compute kernel. Each work-item is initialized with its unique address (index) within the grid. Based on this index, the work-item computes the address of the data it is required to work on and what to do with the results.

## 2.3. Data Sharing

The AMD RDNA stream processors are designed to share data between different work-items. Data sharing can boost performance. The figure below shows the memory hierarchy that is available to each work-item.



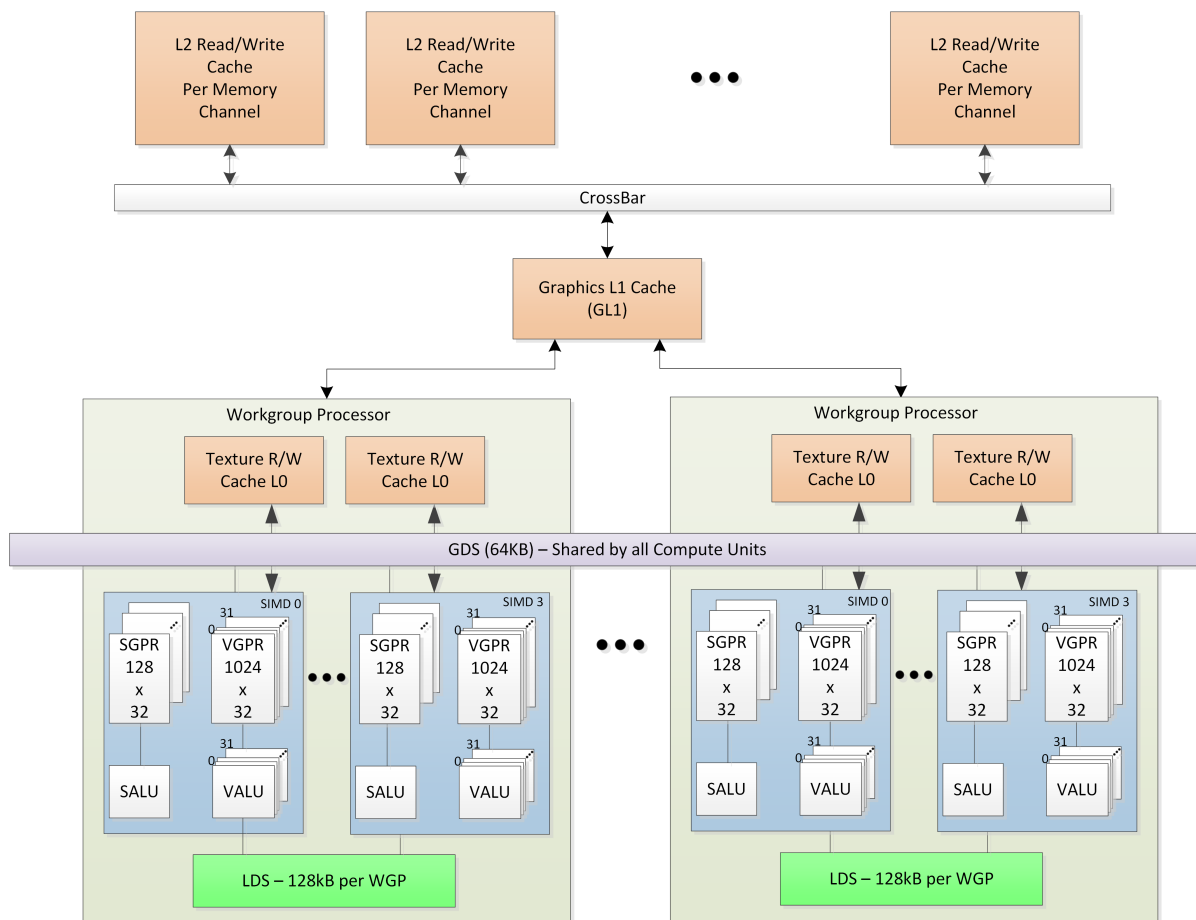

Figure 2. Shared Memory Hierarchy

### 2.3.1. Local Data Share (LDS)

Each workgroup processor (WGP) has a 128 kB memory space that enables low-latency communication between work-items within a workgroup, or the work-items within a wavefront; this is the local data share (LDS). This memory is configured with 64 banks, each with 512 entries of 4 bytes. The AMD RDNA processors use a 128 kB local data share (LDS) memory for each WGP; this enables 128 kB of low-latency bandwidth to the processing elements. The shared memory contains 64 integer atomic units to enable fast, unordered atomic operations. This memory can be used as a software cache for predictable re-use of data, a data exchange machine for the work-items of a workgroup, or as a cooperative way to enable efficient access to off-chip memory. A single workgroup may allocate up to 64kB of LDS space.

#### LDS Allocation Modes

When a workgroup is dispatched or a graphics draw is launched, the waves can allocate LDS space in one of two modes: CU or WGP mode. The shader can simultaneously execute some waves in LDS mode and other waves in CU mode.

- **CU mode:** in this mode, the LDS is effectively split into a separate upper and lower LDS,

each serving two SIMD32's.

Wave are allocated LDS space within the half of LDS which is associated with the SIMD the wave is running on.

For workgroups, all waves are assigned to the pair of SIMD32's. This mode may provide faster operation since both halves run in parallel, but limits data sharing (upper waves cannot read data in the lower half of LDS and vice versa).

When in CU mode, all waves in the workgroup are resident within the same CU.

- **WGP mode:** in this mode, the LDS is one large contiguous memory that all waves on the WGP can access.

In WGP mode, waves of a workgroup may be distributed across both CU's (all 4 SIMD32's) in the WGP.

### 2.3.2. Global Data Share (GDS)

The AMD RDNA devices use a 64 kB global data share (GDS) memory that can be used by wavefronts of a kernel on all WGPs. This memory provides 128 bytes per cycle of memory access to all the processing elements. The GDS is configured with 32 banks, each with 512 entries of 4 bytes each. It is designed to provide full access to any location for any processor. The shared memory contains 32 integer atomic units to enable fast, unordered atomic operations. This memory can be used as a software cache to store important control data for compute kernels, reduction operations, or a small global shared surface. Data can be preloaded from memory prior to kernel launch and written to memory after kernel completion. The GDS block contains support logic for unordered append/consume and domain launch ordered append/consume operations to buffers in memory. These dedicated circuits enable fast compaction of data or the creation of complex data structures in memory.

## 2.4. Device Memory

The AMD RDNA devices offer several methods for access to off-chip memory from the processing elements (PE) within each WGP. On the primary read path, the device consists of multiple channels of L2 cache that provides data to Read-only L1 caches, and finally to L0 caches per WGP. Specific cache-less load instructions can force data to be retrieved from device memory during an execution of a load clause. Load requests that overlap within the clause are cached with respect to each other. The output cache is formed by two levels of cache: the first for write-combining cache (collect scatter and store operations and combine them to provide good access patterns to memory); the second is a read/write cache with atomic units that lets each processing element complete unordered atomic accesses that return the initial value. Each processing element provides the destination address on which the atomic operation acts, the data to be used in the atomic operation, and a return address for the read/write atomic unit to store the pre-op value in memory. Each store or atomic operation can be set up to return an acknowledgment to the requesting PE upon write confirmation of the return value (pre-atomic op value at destination) being stored to device memory.

This acknowledgment has two purposes:

- enabling a PE to recover the pre-op value from an atomic operation by performing a cache-less load from its return address after receipt of the write confirmation acknowledgment, and
- enabling the system to maintain a relaxed consistency model.

Each scatter write from a given PE to a given memory channel maintains order. The acknowledgment enables one processing element to implement a fence to maintain serial consistency by ensuring all writes have been posted to memory prior to completing a subsequent write. In this manner, the system can maintain a relaxed consistency model between all parallel work-items operating on the system.

## 2.5. Shader Padding Requirement

Due to aggressive instruction prefetching used in some graphics devices, the user must pad all shaders with 64 extra dwords (256 bytes) of data past the end of the shader. It is recommended to use the `S_CODE_END` instruction as padding. This ensures that if the instruction prefetch hardware goes beyond the end of the shader, it may not reach into uninitialized memory (or unmapped memory pages).

The amount of shader padding required is related to how far the shader hardware may prefetch ahead. The shader can be set to prefetch 1, 2 or 3 cachelines (64 bytes) ahead of the current program counter. This is controlled via a wave-launch state register, or by the shader program itself with `S_INST_PREFETCH`.

## Chapter 3. Kernel State

This chapter describes the kernel states visible to the shader program.

### 3.1. State Overview

The table below shows the hardware states readable or writable by a shader program. All registers below are unique to each wave except for TBA and TMA which are shared.

*Table 2. Readable and Writable Hardware States*

Abbrev.	Name	Size (bits)	Description
PC	Program Counter	48	Points to the memory address of the next shader instruction to execute.
V0-V255	VGPR	32	Vector general-purpose register.
S0-S105	SGPR	32	Scalar general-purpose register.
LDS	Local Data Share	64kB	Local data share is a scratch RAM with built-in arithmetic capabilities that allow data to be shared between threads in a workgroup.
EXEC	Execute Mask	64	A bit mask with one bit per thread, which is applied to vector instructions and controls that threads execute and that ignore the instruction.
EXECZ	EXEC is zero	1	A single bit flag indicating that the EXEC mask is all zeros.
VCC	Vector Condition Code	64	A bit mask with one bit per thread; it holds the result of a vector compare operation.
VCCZ	VCC is zero	1	A single bit-flag indicating that the VCC mask is all zeros.
SCC	Scalar Condition Code	1	Result from a scalar ALU comparison instruction.
FLAT_SCRATCH	Flat scratch address	64	The base address of scratch memory.
STATUS	Status	32	Read-only shader status bits.
MODE	Mode	32	Writable shader mode bits.
M0	Memory Reg	32	A temporary register that has various uses, including GPR indexing and bounds checking.
TRAPSTS	Trap Status	32	Holds information about exceptions and pending traps.
TBA	Trap Base Address	64	Holds the pointer to the current trap handler program.
TMA	Trap Memory Address	64	Temporary register for shader operations. For example, can hold a pointer to memory used by the trap handler.

Abbrev.	Name	Size (bits)	Description
TTMP0-TTMP15	Trap Temporary SGPRs	32	16 SGPRs available only to the Trap Handler for temporary storage.
VMCNT	Vector memory instruction count	6	Counts the number of VMEM load instructions issued but not yet completed.
VSCNT	Vector memory instruction count	6	Counts the number of VMEM store instructions issued but not yet completed.
EXPCNT	Export Count	3	Counts the number of Export and GDS instructions issued but not yet completed. Also counts VMEM writes that have not yet sent their write-data to the last level cache.
LGKMCNT	LDS, GDS, Constant and Message count	4	Counts the number of LDS, GDS, constant-fetch (scalar memory read), and message instructions issued but not yet completed.

## 3.2. Program Counter (PC)

The program counter (PC) is a byte address pointing to the next instruction to execute. When a wavefront is created, the PC is initialized to the first instruction in the program.

The PC interacts with three instructions: `S_GET_PC`, `S_SET_PC`, `S_SWAP_PC`. These transfer the PC to, and from, an even-aligned SGPR pair.

Branches jump to (`PC_of_the_instruction_after_the_branch + offset`). The shader program cannot directly read from, or write to, the PC. Branches, `GET_PC` and `SWAP_PC`, are PC-relative to the next instruction, not the current one. `S_TRAP` saves the PC of the `S_TRAP` instruction itself.

## 3.3. EXECute Mask

The Execute mask (64-bit) determines which threads in the vector are executed:

1 = execute, 0 = do not execute.

EXEC can be read from, and written to, through scalar instructions; it also can be written as a result of a vector-ALU compare (`V_CMPX`). This mask affects vector-ALU, vector-memory, LDS, GDS, and export instructions. It does not affect scalar (ALU or memory) execution or branches.

A helper bit (EXECZ) can be used as a condition for branches to skip code when EXEC is zero.

Wave32: the upper 32-bit of EXEC are ignored, and EXECZ represents the status of only the lower 32-bits of EXEC.

This GPU can optimize instruction execution when EXEC = 0. The shader hardware can skip vector ALU and memory instructions if EXEC is known to be zero, but with some limitations:

- VALU instructions can be skipped, unless they write SGPRs (these are not skipped)
- Wave64 memory instructions: can skip one half but not the entire instruction
- Wave32 memory instructions: not skipped

Use CBRANCH to rapidly skip over code when it is likely that the EXEC mask is zero.

## 3.4. Status registers

Status register fields can be read, but not written to, by the shader. These bits are initialized at wavefront-creation time. The table below lists and briefly describes the status register fields.

*Table 3. Status Register Fields*

Field	Bit Position	Description
SCC	1	Scalar condition code. Used as a carry-out bit. For a comparison instruction, this bit indicates failure or success. For logical operations, this is 1 if the result was non-zero.
SPI_Prio	2:1	Wavefront priority set by the shader processor interpolator (SPI) when the wavefront is created. See the S_SETPRIO instruction (page 12-49) for details. 0 is lowest, 3 is highest priority.
USER_Prio	4:3	User settable wave-priority set by the shader program. See the S_SETPRIO instruction (page 12-49) for details.
PRIV	5	Privileged mode. Can only be active when in the trap handler. Gives write access to the TTMP, TMA, and TBA registers.
TRAP_EN	6	Indicates that a trap handler is present. When set to zero, traps are not taken.
TTRACE_EN	7	Indicates whether thread trace is enabled for this wavefront. If zero, also ignore any shader-generated (instruction) thread-trace data.
EXPORT_RDY	8	This status bit indicates if export buffer space has been allocated. The shader stalls any export instruction until this bit becomes 1. It is set to 1 when export buffer space has been allocated. Before a Pixel or Vertex shader can export, the hardware checks the state of this bit. If the bit is 1, export can be issued. If the bit is zero, the wavefront sleeps until space becomes available in the export buffer. Then, this bit is set to 1, and the wavefront resumes.
EXECZ	9	Exec mask is zero.
VCCZ	10	Vector condition code is zero.
IN_WG	11	Wavefront is a member of a work-group of more than one wavefront.

Field	Bit Position	Description
IN_BARRIER	12	Wavefront is waiting at a barrier.
HALT	13	Wavefront is halted or scheduled to halt. HALT can be set by the host through wavefront-control messages, or by the shader. This bit is ignored while in the trap handler (PRIV = 1); it also is ignored if a host-initiated trap is received (request to enter the trap handler).
TRAP	14	Wavefront is flagged to enter the trap handler as soon as possible.
TTRACE_SIMD_EN	15	Enables/disables thread trace for this SIMD. This bit allows more than one SIMD to be outputting USERDATA (shader initiated writes to the thread-trace buffer). Note that wavefront data is only traced from one SIMD per shader engine. Wavefront user data (instruction based) can still be output if this bit is zero.
VALID	16	Wavefront is active (has been created and not yet ended).
ECC_ERR	17	An ECC error has occurred.
SKIP_EXPORT	18	For Vertex Shaders only. 1 = this shader is not allocated export buffer space; all export instructions are ignored (treated as NOPs). Formerly called VS_NO_ALLOC. Used for stream-out of multiple streams (multiple passes over the same VS), and for DS running in the VS stage for wavefronts that produced no primitives.
PERF_EN	19	Performance counters are enabled for this wavefront.
COND_DBG_USER	20	Conditional debug indicator for user mode
COND_DBG_SYS	21	Conditional debug indicator for system mode.
FATAL_HALT	23	Set if the wave experienced a fatal error.
MUST_EXPORT	27	This wavefront is required to perform an export with Done=1 before terminating.

## 3.5. Mode register

Mode register fields can be read from, and written to, by the shader through scalar instructions. The table below lists and briefly describes the mode register fields.

*Table 4. Mode Register Fields*

Field	Bit Position	Description
FP_ROUND	3:0	[1:0] Single precision round mode. [3:2] Double/Half-precision round mode. Round Modes: 0=nearest even, 1= +infinity, 2= -infinity, 3= toward zero.
FP_DENORM	7:4	[1:0] Single denormal mode. [3:2] Double/Half-precision denormal mode. Denorm modes: 0 = flush input and output denorms. 1 = allow input denorms, flush output denorms. 2 = flush input denorms, allow output denorms. 3 = allow input and output denorms.

Field	Bit Position	Description
DX10_CLAMP	8	Used by the vector ALU to force DX10-style treatment of NaNs: when set, clamp NaN to zero; otherwise, pass NaN through.
IEEE	9	Floating point opcodes that support exception flag gathering quiet and propagate signaling NaN inputs per IEEE 754-2008. Min_dx10 and max_dx10 become IEEE 754-2008 compliant due to signaling NaN propagation and quieting.
LOD_CLAMPED	10	Sticky bit indicating that one or more texture accesses had their LOD clamped.
DEBUG	11	Forces the wavefront to jump to the exception handler after each instruction is executed (but not after ENDPGM). Only works if TRAP_EN = 1.
EXCP_EN	20:12	Enable mask for exceptions. Enabled means if the exception occurs and TRAP_EN==1, a trap is taken. [12] : invalid. [13] : inputDenormal. [14] : float_div0. [15] : overflow. [16] : underflow. [17] : inexact. [18] : int_div0. [19] : address watch
FP16_OVFL	23	If set, an overflowed FP16 result is clamped to +/- MAX_FP16, regardless of round mode, while still preserving true INF values.
DISABLE_PERF	27	1 = disable performance counting for this wave

## 3.6. GPRs and LDS

This section describes how GPR and LDS space is allocated to a wavefront, as well as how out-of-range and misaligned accesses are handled.

### 3.6.1. Out-of-Range behavior

This section defines the behavior when a source or destination GPR or memory address is outside the legal range for a wavefront.

Out-of-range can occur through GPR-indexing or bad programming. It is illegal to index from one register type into another (for example: SGPRs into trap registers or inline constants). It is also illegal to index within inline constants.

The following describe the out-of-range behavior for various storage types.

- SGPRs
  - SGPRs cannot be "out of range".



However, it is illegal to index from one range to another, or for a 64-bit operand to straddle two ranges.

The ranges are: [ SGPRs 0-105 and VCCH, VCCL], [ Trap Temps 0-15 ], [ all other values ]

- VGPRs
  - It is illegal to index from SGPRs into VGPRs, or vice versa.
  - Out-of-range = (vgpr < 0 || (vgpr >= vgpr\_size))
  - If a source VGPR is out of range, VGPR0 is used.
  - If a destination VGPR is out-of-range, the instruction is ignored and nothing is written (treated as an NOP).
- LDS
  - If the LDS-ADDRESS is out-of-range (addr < 0 or > (MIN(lds\_size, m0))):
    - Writes out-of-range are discarded; it is undefined if SIZE is not a multiple of write-data-size.
    - Reads return the value zero.
  - If any source-VGPR is out-of-range, the VGPR0 value is used.
  - If the dest-VGPR is out of range, nullify the instruction (issue with exec=0)
- Memory, LDS, and GDS: Reads and atomics with returns.
  - If any source VGPR or SGPR is out-of-range, the data value is undefined.
  - If any destination VGPR is out-of-range, the operation is nullified by issuing the instruction as if the EXEC mask were cleared to 0.
    - This out-of-range check must check all VGPRs that can be returned (for example: VDST to VDST+3 for a BUFFER\_LOAD\_DWORDx4).
    - This check must also include the extra PRT (partially resident texture) VGPR and nullify the fetch if this VGPR is out-of-range, no matter whether the texture system actually returns this value or not.
    - Atomic operations with out-of-range destination VGPRs are nullified: issued, but with exec mask of zero.

Instructions with multiple destinations (for example: V\_ADDC): if any destination is out-of-range, no results are written.

### 3.6.2. SGPR Allocation and storage

Every wavefront is allocated a fixed number of SGPRs:

- 106 normal SGPRs
- VCCh and VCCI (stored in SGPRs 106 and 107)
- 16 Trap-temporary SGPRs, meant for use by the trap handler

### 3.6.3. SGPR Alignment

Even-aligned SGPRs are required in the following cases.

- When 64-bit data is used. This is required for moves to/from 64-bit registers, including the PC.
- When scalar memory reads that the address-base comes from an SGPR-pair (either in SGPR).

Quad-alignment is required for the data-GPR when a scalar memory read returns four or more Dwords. When a 64-bit quantity is stored in SGPRs, the LSBs are in SGPR[n], and the MSBs are in SGPR[n+1].

### 3.6.4. VGPR Allocation and Alignment

VGPRs are allocated in groups of 8 Dwords for wave64, and 16 Dwords for wave32. Operations using pairs of VGPRs (for example: double-floats) have no alignment restrictions. Physically, allocations of VGPRs can wrap around the VGPR memory pool.

### 3.6.5. Wave Shared VGPRs

Wave64's can be allocated wave-private and wave-shared VGPRs. Private GPRs are the normal ones where each lane has a unique value. Shared VGPRs are shared between the high and low halves of a wave64. This can be useful to reduce overall VGPR usage when combined with subvector execution. Shared VGPRs are allocated in blocks of 16 Dwords.

Shared VGPRs logically occupy the VGPR addresses immediately following the private VGPRs. E.g. if a wave has 8 private VGPRs, they are V0-V7 and shared VGPRs start at V8. If there are 16 shared VGPRs, they are accessed as V8-23.

Shared VGPRs cannot be used for: Exports or GDS.

### 3.6.6. LDS Allocation and Clamping

LDS is allocated per work-group or per-wavefront when work-groups are not in use. LDS space is allocated to a work-group or wavefront in contiguous blocks of 256 Dwords on 256-Dword alignment. LDS allocations do not wrap around the LDS storage. All accesses to LDS are restricted to the space allocated to that wavefront/work-group.

## 3.7. M# Memory Descriptor

There is one 32-bit M# (M0) register per wavefront, which can be used for:

- Local Data Share (LDS)
  - Interpolation: holds { 1'b0, new\_prim\_mask[15:1], parameter\_offset[15:0] } // in bytes
  - LDS direct-read offset and data type: { 13'b0, DataType[2:0], LDS\_address[15:0] } // addr in bytes
  - LDS "add\_TID" read/write: { 16'h0, lds\_offset[15:0] } // offset in bytes
- Global Data Share (GDS)
  - { base[15:0] , size[15:0] } // base and size are in bytes
- Indirect GPR addressing for both vector and scalar instructions. M0 is an unsigned index.
- Send-message value. EMIT/CUT use M0 and EXEC as the send-message data.
- Index value used by S\_MOVREL and V\_MOVREL

## 3.8. SCC: Scalar Condition code

Most scalar ALU instructions set the Scalar Condition Code (SCC) bit, indicating the result of the operation.

Compare operations: 1 = true  
 Arithmetic operations: 1 = carry out  
 Bit/logical operations: 1 = result was not zero  
 Move: does not alter SCC

The SCC can be used as the carry-in for extended-precision integer arithmetic, as well as the selector for conditional moves and branches.

## 3.9. Vector Compares: VCC and VCCZ

Vector ALU comparisons set the Vector Condition Code (VCC) register (1=pass, 0=fail). Also, vector compares have the option of setting EXEC to the VCC value.

There is also a VCC summary bit (vccz) that is set to 1 when the VCC result is zero. This is useful for early-exit branch tests. VCC is also set for selected integer ALU operations (carry-out).

Vector compares have the option of writing the result to VCC (32-bit instruction encoding) or to any SGPR (64-bit instruction encoding). VCCZ is updated every time VCC is updated: vector compares and scalar writes to VCC.

The EXEC mask determines which threads execute an instruction. The VCC indicates which executing threads passed the conditional test, or which threads generated a carry-out from an integer add or subtract.

$$V\_CMP\_* \Rightarrow VCC[n] = EXEC[n] \& (\text{test passed for thread}[n])$$

VCC is fully written; there are no partial mask updates.



VCC physically resides in the SGPR register file, so when an instruction sources VCC, that counts against the limit on the total number of SGPRs that can be sourced for a given instruction. VCC physically resides in the highest two user SGPRs.

When used by a wave32, the upper 32 bits of VCC are unused and only the lower 32 bits of VCC contribute to the value of VCCZ.

## 3.10. Trap and Exception registers

Each type of exception can be enabled or disabled independently by setting, or clearing, bits in the TRAPSTS register's EXCP\_EN field. This section describes the registers which control and report kernel exceptions.

All Trap temporary SGPRs (TTMP\*) are privileged for writes - they can be written only when in the trap handler (status.priv = 1). When not privileged, writes to these are ignored. TMA and TBA are read-only; they can be accessed through S\_GETREG\_B32.

When a trap is taken (either user initiated, exception or host initiated), the shader hardware is designed to generate an S\_TRAP instruction. This loads trap information into a pair of SGPRs:

$$\{TTMP1, TTMP0\} = \{1'h0, pc\_rewind[5:0], HT[0], trapID[7:0], PC[47:0]\}.$$

HT is set to one for host initiated traps, and zero for user traps (s\_trap) or exceptions. TRAP\_ID is zero for exceptions, or the user/host trapID for those traps. When the trap handler is entered, the PC of the faulting instruction is:  $(PC - PC\_rewind * 4)$ .

**STATUS . TRAP\_EN** - This bit indicates to the shader whether or not a trap handler is present. When one is not present, traps are not taken, no matter whether they're floating point, user-, or host-initiated traps. When the trap handler is present, the wavefront uses an extra 16 SGPRs for trap processing. If trap\_en == 0, all traps and exceptions are ignored, and s\_trap is converted by hardware to NOP.

**MODE . EXCP\_EN[8:0]** - Floating point exception enables. Defines which exceptions and events cause a trap.

Bit	Exception
0	Invalid
1	Input Denormal
2	Divide by zero
3	Overflow
4	Underflow
5	Inexact
6	Integer divide by zero
7	Address Watch - the cache has witnessed a thread access to an 'address of interest'

### 3.10.1. Trap Status register

The trap status register records previously seen traps or exceptions. It can be read and written by the kernel.

Table 5. Exception Field Bits

Field	Bits	Description
EXCP	8:0	Status bits of which exceptions have occurred. These bits are sticky and accumulate results until the shader program clears them. These bits are accumulated regardless of the setting of EXCP_EN. These can be read or written without shader privilege. Bit Exception 0 invalid 1 Input Denormal 2 Divide by zero 3 overflow 4 underflow 5 inexact 6 integer divide by zero 7 address watch 0 8 memory violation
SAVECTX	10	A bit set by the host command indicating that this wave must jump to its trap handler and save its context. This bit must be cleared by the trap handler using S_SETREG. Note - a shader can set this bit to 1 to cause a save-context trap, and due to hardware latency the shader may execute up to 2 additional instructions before taking the trap.
ILLEGAL_INST	11	An illegal instruction has been detected.
ADDR_WATCH1-3	14:12	Indicates that address watch 1, 2, or 3 has been hit. Bit 12 is address watch 1; bit 13 is 2; bit 14 is 3.
BUFFER_OOB	15	A buffer instruction has addresses data which is out of range.
XNACK_ERROR	28	A memory address translation error has occurred.

Field	Bits	Description
DP_RATE	31:29	Determines how the shader interprets the TRAP_STS.cycle. Different Vector Shader Processors (VSP) process instructions at different rates.

## 3.11. Memory Violations

A Memory Violation is reported from:

- LDS alignment error.
- Memory read/write/atomic alignment error.
- Flat access where the address is invalid (does not fall in any aperture).
- Write to a read-only surface.
- GDS alignment or address range error.
- GWS operation aborted (semaphore or barrier not executed).

Memory violations are not reported for instruction or scalar-data accesses.

Memory Buffer to LDS does NOT return a memory violation if the LDS address is out of range, but masks off EXEC bits of threads that would go out of range.

When a memory access is in violation, the appropriate memory (LDS or cache) returns MEM\_VIOL to the wave. This is stored in the wave's TRAPSTS.mem\_viol bit. This bit is sticky, so once set to 1, it remains at 1 until the user clears it.

Memory violations are fatal: if a trap handler is present and the wave is not already in the trap handler, the wave jumps to the trap handler; otherwise it signals an interrupt and halt.

Memory violations are not precise. The violation is reported when the LDS or cache processes the address; during this time, the wave may have processed many more instructions. When a mem\_viol is reported, the Program Counter saved is that of the next instruction to execute; it has no relationship the faulting instruction.

## 3.12. Initial Wave State

When a wave is launched, some of the state data is pre-initialized. This section describes what state is initialized per shader stage. Note that as usual in this spec, the shader stages refer to hardware shader stages and these often are not identical to software shader stages.

State initialization is controlled by state registers which are defined in other documentation.

### 3.12.1. State Registers

Table 6. State Register Initialization

<b>Program Counter (PC)</b>	<b>program start – from SPI_SHADER_PGM_LO/HI</b>
Execute mask (EXEC)	workitem valid mask. Indicates which workitems are valid for this wavefront. Wave32 uses only bits 31-0. The combined ES+GS, HS+LS loads a dummy non-zero value into EXEC, and the shader must calculate the real value from initialized SGPRs.
Trap Status (TRAPSTS)	0
MODE.round/denorm	Round and denormal modes are initialized from: SPI_SHADER_PGM_RSRC1_*.{float,round}_mode
MODE.debug/dx_clamp	Similar for "debug" and "dx10_clamp".
EXCP_EN	Initialzed from SPI_SHADER_PGM_RSRC2_*.excp_en

### 3.12.2. SGPR Initialization

SGPRs are initialized based on various SPI\_PGM\_RSRC\* register setting. It is important to know that only the enabled values are loaded, and they are packed into consecutive SGPRs.

#### Pixel Shader (PS)

SGPR Order	Description	Enable
First 0..32 of	User data registers	SPI_SHADER_PGM_RSRC2_PS.user_sgpr
then	{bc_optimize, prim_mask[14:0], lds_offset[15:0]}	N/A
then	{ps_wave_id[9:0], ps_wave_index[2:0]}	SPI_SHADER_PGM_RSRC2_PS.wave_cnt_en
then	POPS collision wave ID {DidOverlap, 2'b0, Packer ID[0], 4'b0, Newest Overlapped WaveID[11:0], WaveID[11:0]}	SPI_SHADER_PGM_RSRC2_PS.load_collision_waveID
then	{16'b0, Intra-Wave Quad Overlap[15:0]}	SPI_SHADER_PGM_RSRC2_PS.load_intrawave_collisions
then	Provoking Vertex	SPI_SHADER_PGM_RSRC1_PS.load_provoking_vtx
then	Scratch offset, in bytes	SPI_SHADER_PGM_RSRC2_PS.scratch_en

#### Vertex Shader (VS)

SGPR Order	Description	Enable
First 0.. 32 of	User data registers	SPI_SHADER_PGM_RSRC2_VS.user_sgpr

SGPR Order	Description	Enable
then	{stream_id[1:0], is_offchip, streamout_vtx_count[6:0], streamout_enable[15:0]}	SPI_SHADER_PGM_RSRC2_VS.so_en    SPI_SHADER_PGM_RSRC2_VS.oc_lds_en
then	streamout_write_index[31:0]	SPI_SHADER_PGM_RSRC2_VS.so_en
then	streamout_offset0[31:0]	SPI_SHADER_PGM_RSRC2_VS.so_base0_en
then	streamout_offset1[31:0]	SPI_SHADER_PGM_RSRC2_VS.so_base1_en
then	streamout_offset2[31:0]	SPI_SHADER_PGM_RSRC2_VS.so_base2_en
then	streamout_offset3[31:0]	SPI_SHADER_PGM_RSRC2_VS.so_base3_en
then	offchip_lds_pointer[31:0] in bytes	SPI_SHADER_PGM_RSRC2_VS.oc_lds_en
then	waveID (dispatch draw term)	SPI_SHADER_PGM_RSRC2_VS.dispatch_draw_en
then	pc_base	SPI_SHADER_PGM_RSRC2_VS.pc_base_en
then	Scratch offset (in bytes)	SPI_SHADER_PGM_RSRC2_VS.scratch_en

### Geometry Shader (ES+GS)

SGPR Order	Description	Enable
0	GS User Data Address Low ([31:0]) comes from: SPI_SHADER_USER_DATA_LO_GS	automatically enabled
1	GS User Data Address High ([47:32]) comes from: SPI_SHADER_USER_DATA_HI_GS	automatically enabled
2	GS2VS Ring buffer offset[31:0] (byte) OR Control SB offset   Ordered Wave ID {wave_crawler_inc[2:0], 16'h0, ordered_wave_id[12:0]}	VGT_SHADER_STAGES.primgen_en
3	{ TGsize[3:0], WaveInSubgroup[3:0], GSWaveID[7:0], GSPrimCount[7:0], ESVertCount[7:0]}	automatically enabled
4	Off-chip LDS base [31:0]	SPI_SHADER_PGM_RSRC2_GS.oc_lds_en
5	Shared Scratch Offset	SPI_SHADER_PGM_RSRC2_GS.scratch_en
6	GS Shader address low comes from: SPI_SHADER_PGM_LO_GS	automatically enabled
7	GS Shader address high comes from: SPI_SHADER_PGM_HI_GS	automatically enabled
then 0.. 32 of	User data registers of GS shader	SPI_SHADER_PGM_RSRC2_GS.user_sgpr



## Front End Shader (LS+HS)

SGPR Order	Description	Enable
0	HS User Data Address Low ([31:0])	SPI_SHADER_USER_DATA_LO_HS
1	HS User Data Address High ([47:32])	SPI_SHADER_USER_DATA_HI_HS
2	Off-chip LDS base [31:0]	automatically enabled
3	{first_wave, lshs_TGsize[6:0], lshs_PatchCount[7:0], HS_vertCount[7:0], LS_vertCount[7:0]}	automatically enabled
4	TF buffer base [15:0]	automatically enabled
5	Shared Scratch Offset	SPI_SHADER_PGM_RSRC2_HS.scratch_en
6	HS Shader address low	SPI_SHADER_PGM_LO_HS
7	HS Shader address high	SPI_SHADER_PGM_HI_HS
then 0.. 32 of	User data registers of HS shader	SPI_SHADER_PGM_RSRC2_HS.user_sgpr

## Compute Shader (CS)

SGPR Order	Description	Enable
First 0.. 16 of	User data registers	COMPUTE_PGM_RSRC2.user_sgpr
then	threadgroup_id0[31:0]	COMPUTE_PGM_RSRC2.tgid_x_en
then	threadgroup_id1[31:0]	COMPUTE_PGM_RSRC2.tgid_y_en
then	threadgroup_id2[31:0]	COMPUTE_PGM_RSRC2.tgid_z_en
then	{first_wave, 6'h00, wave_id_in_group[4:0], 2'h0, ordered_append_term[11:0], threadgroup_size_in_waves[5:0]}	COMPUTE_PGM_RSRC2.tg_size_en
then	Scratch offset (in bytes)	COMPUTE_PGM_RSRC2.scratch_en

Compute shaders have up to 3 VGPRs initialized as well:

- VGPR0 = thread ID in group, X dimension
- VGPR1 = thread ID in group, Y dimension
- VGPR2 = thread ID in group, Z dimension

# Chapter 4. Program Flow Control

All program flow control is programmed using scalar ALU instructions. This includes loops, branches, subroutine calls, and traps. The program uses SGPRs to store branch conditions and loop counters. Constants can be fetched from the scalar constant cache directly into SGPRs.

## 4.1. Program Control

The instructions in the table below control the priority and termination of a shader program, as well as provide support for trap handlers.

Table 7. Control Instructions

Instructions	Description
S_ENDPGM	Terminates the wavefront. It can appear anywhere in the kernel and can appear multiple times.
S_ENDPGM_SAVED	Terminates the wavefront due to context save. It can appear anywhere in the kernel and can appear multiple times.
S_NOP	Does nothing; it can be repeated in hardware up to eight times.
S_TRAP	Jumps to the trap handler.
S_RFE	Returns from the trap handler
S_SETPRIO	Modifies the priority of this wavefront: 0=lowest, 3 = highest.
S_SLEEP	Causes the wavefront to sleep for 64 - 960 clock cycles.
S_SENDMSG	Sends a message (typically an interrupt) to the host CPU.
S_CLAUSE	Define a clause of instructions which are executed together.
S_VERSION	Does nothing (treated as S_NOP), but can be used as a code comment to indicate the hardware version the shader is compiled for (using the SIMM16 field).
S_CODE_END	Treated as an illegal instruction. Used to pad past the end of shaders.

### 4.1.1. Instruction Clauses

An **instruction clause** is a group of instructions of the same type which are to be executed in an uninterrupted sequence. Normally the shader hardware may interleave instructions from different waves in order to maintain performance, but a clause can be used to override that behavior and force the hardware to service only one wave for a given instruction type for the duration of the clause.

Clauses are defined by the S\_CLAUSE instructions, which specifies the number of instructions that make up the clause. The clause-type is implicitly defined by the type of instruction immediately following the clause. Clause types are:

- VALU
- SMEM
- LDS
- FLAT
- Texture, buffer, global and scratch

Clauses must contain only one instruction type.

## 4.2. Branching

Branching is done using one of the following scalar ALU instructions.

*Table 8. Branch Instructions*

Instructions	Description
S_BRANCH	Unconditional branch.
S_CBRANCH_<test>	Conditional branch. Branch only if <test> is true. Tests are VCCZ, VCCNZ, EXECZ, EXECNZ, SCCZ, and SCCNZ.
S_CBRANCH_CDBGSYS	Conditional branch, taken if the COND_DBG_SYS status bit is set.
S_CBRANCH_CDBGUSER	Conditional branch, taken if the COND_DBG_USER status bit is set.
S_CBRANCH_CDBGSYS_AND_USER	Conditional branch, taken only if both COND_DBG_SYS and COND_DBG_USER are set.
S_SETPC	Directly set the PC from an SGPR pair.
S_SWAPPC	Swap the current PC with an address in an SGPR pair.
S_GETPC	Retrieve the current PC value (does not cause a branch).
S_CALL_B64	Jump to a subroutine, and save return address. SGPR_pair = PC+4; PC = PC+4+SIMM16*4.
S_SUBVECTOR_LOOP_BEGIN	Starts a subvector execution loop. The SIMM16 field is the branch offset to the instruction after S_SUBVECTOR_LOOP_END, and the SGPR is used for temporary EXEC storage.
S_SUBVECTOR_LOOP_END	Marks the end of the subvector execution loop. The SIMM16 field points back to the instruction after S_SUBVECTOR_LOOP_BEGIN, and the SGPR is used for temporary EXEC storage.

For conditional branches, the branch condition can be determined by either scalar or vector operations. A scalar compare operation sets the Scalar Condition Code (SCC), which then can be used as a conditional branch condition. Vector compare operations set the VCC mask, and VCCZ or VCCNZ then can be used to determine branching.

### 4.2.1. Subvector Execution

“Subvector execution” is an alternate method of handling wave64 instruction execution. The

normal method is to issue each half of a wave64 as two wave32 instructions, then move on to the next instruction. This alternative method is to issue a group of instructions, all for the first 32 workitems and then come back and execute the same instructions but for the second 32 workitems. This has two potential advantages:

- Memory operations are for smaller units of work and may cache better
  - example: reading multiple entries from a strided buffer
- Wave-temporary VGPRs are available:
  - In Wave64 each wave may declare N normal VGPRs (the wave gets  $64 * N$  dwords, with N per work-item), and M temp VGPRs which may only be used in this mode. The temp VGPRs are physically adjacent to the normal ones, but logically are from just after the private VGPRs. These can be used on each pass of the subvector execution.

This mode is explicitly declared in shader code as a loop:

```

S_subvector_loop_begin S0, skip_all
loop_start:
< vec32 code >
S_subvector_loop_end S0, loop_start
skip_all:
    
```

Table 9. SubVector Execution Order

Shader Program	Normal Execution Sequence	Subvector Loop Execution Sequence
inst0	inst0 - low	inst0 - low
inst1	inst0 - high	inst1 - low
inst2	inst1 - low	inst2 - low
inst3	inst1 - high	inst3 - low
	inst2 - low	inst0 - high
	inst2 - high	inst1 - high
	inst3 - low	inst2 - high
	inst3 - high	inst3 - high

Subvector execution is simply a loop construct where half of the EXEC mask is zero for each pass over the body of the code. All wave64 rules still apply. The loop executes zero, one or two times, depending on the initial state of the EXEC mask. During each pass of the loop, one half of EXEC is forced to zero (after being saved in an SGPR). The EXEC mask is restored at the end of the loop.

If EXECHI = 0: the body is executed only once: EXECLO is stored in S0 and restored at the end, but it was zero anyway. If EXEC\_LO was zero at the start, the same thing happens. If both halves of EXEC are non-zero, do the low pass first (storing EXECHI in S0), then restore EXECHI and save off EXECLO and do it again. Restore EXECLO at the end of the second pass. The “pass #” is encoded by observing which half of EXEC is zero.

Subvector looping imposes a rule that the “body code” cannot let the working half of the exec mask go to zero. If it might go to zero, it must be saved at the start of the loop and be restored

before the end since the `S_SUBVECTOR_LOOP_*` instructions determine which pass they're in by looking at which half of `EXEC` is zero.

## 4.3. Workgroups

Work-groups are collections of wavefronts running on the same workgroup processor which can synchronize and share data. Up to 1024 work-items (16 wave64's or 32 wave32's) can be combined into a work-group. When multiple wavefronts are in a workgroup, the `S_BARRIER` instruction can be used to force each wavefront to wait until all other wavefronts reach the same instruction; then, all wavefronts continue. Any wavefront may terminate early using `S_ENDPGM`, and the barrier is considered satisfied when the remaining live waves reach their barrier instruction.

## 4.4. Data Dependency Resolution

Shader hardware can resolve most data dependencies, but a few cases must be explicitly handled by the shader program. In these cases, the program must insert `S_WAITCNT` instructions to ensure that previous operations have completed before continuing.

The shader has four counters that track the progress of issued instructions. `S_WAITCNT` waits for the values of these counters to be at, or below, specified values before continuing.

These allow the shader writer to schedule long-latency instructions, execute unrelated work, and specify when results of long-latency operations are needed.

Instructions of a given type return in order, but instructions of different types can complete out-of-order. For example, both `GDS` and `LDS` instructions use `LGKM_cnt`, but they can return out-of-order. `VMEM` loads update `VM_CNT` in the order the instructions were issued, so waiting on `VM_CNT` to be less-than a particular value ensures all previous loads have completed. It is possible for data to be written to `VGPRs` out-of-order. Stores from a wave are not kept in order with stores from that wave.

### **VM\_CNT**

Vector memory count (reads, atomic with return). Determines when memory reads have finished.

- Incremented every time a vector-memory read or atomic-with-return (`MIMG`, `MUBUF`, `MTBUF`, or `FLAT/Scratch/Global` format) instruction is issued.
- Decrement for reads when all of the data for that instruction and those before it have completed.

### **VS\_CNT**

Vector memory store count (writes, atomic without return). Determines when memory writes have completed.

- Incremented every time a vector-memory write or atomic-without-return (MIMG, MUBUF, MTBUF, or Flat/Scratch/Global format) instruction is issued.
- Decrementd for writes when the data has been written to the L2 cache.

### LGKM\_CNT

(LDS, GDS, (K)constant, (M)essage) Determines when one of these low-latency instructions have completed.

- Incremented by 1 for every LDS or GDS instruction issued, as well as by Dword-count for scalar-memory reads. For example.
- Decrementd by 1 for LDS/GDS reads or atomic-with-return when the data has been returned to VGPRs.
- Incremented by 1 for each S\_SENDMSG issued. Decrementd by 1 when message is sent out.
- Decrementd by 1 for LDS/GDS writes when the data has been written to LDS/GDS.
- Decrementd by 1 for each Dword returned from the data-cache (SMEM).

#### Ordering:

- Instructions of different types are returned out-of-order.
- Instructions of the same type are returned in the order they were issued, except scalar-memory-reads, which can return out-of-order (in which case only S\_WAITCNT 0 is the only legitimate value).

### EXP\_CNT

VGPR-export count. Determines when data has been read out of the VGPR and sent to GDS, at which time it is safe to overwrite the contents of that VGPR.

- Incremented when an Export/GDS instruction is issued from the wavefront buffer.
- Decrementd for exports/GDS when the last cycle of the export instruction is granted and executed (VGPRs read out). Ordering
  - Exports are kept in order only within each export type (color/null, position, parameter cache).

## 4.5. Manually Inserted Wait States (NOPs)

Inserting S\_NOP is not required to achieve correct operation.

# Chapter 5. Scalar ALU Operations

Scalar ALU (SALU) instructions operate on a single value per wavefront. These operations consist of 32-bit integer arithmetic and 32- or 64-bit bit-wise operations. The SALU also can perform operations directly on the Program Counter, allowing the program to create a call stack in SGPRs. Many operations also set the Scalar Condition Code bit (SCC) to indicate the result of a comparison, a carry-out, or whether the instruction result was zero.

## 5.1. SALU Instruction Formats

SALU instructions are encoded in one of five microcode formats, shown below:



Figure 3. Scalar ALU format with one source operand



Figure 4. Scalar ALU format with two source operands



Figure 5. Scalar ALU format with one immediate value source operands



Figure 6. Scalar ALU format for compares, with two sources but no destination



Figure 7. Scalar ALU format for program flow operations

Each of these instruction formats uses some of these fields:

Field	Description
OP	Opcode: instruction to be executed.
SDST	Destination SGPR.
SSRC0	First source operand.
SSRC1	Second source operand.
SIMM16	Signed immediate 16-bit integer constant.

The lists of similar instructions sometimes use a condensed form using curly braces { } to express a list of possible names. For example, S\_AND\_{B32, B64} defines two legal instructions: S\_AND\_B32 and S\_AND\_B64.

## 5.2. Scalar ALU Operands

Valid operands of SALU instructions are:

- SGPRs, including trap temporary SGPRs.
- Mode register.
- Status register (read-only).
- M0 register.
- TrapSts register.
- EXEC mask.
- VCC mask.
- SCC.
- Inline constants: integers from -16 to 64, and a some floating point values.
- VCCZ, EXECZ, and SCC.
- Hardware registers.
- 32-bit literal constant.

In the table below, 0-127 can be used as scalar sources or destinations; 128-255 can only be used as sources.

Table 10. Scalar Operands

	Code	Meaning	Description
Scalar Dest (7 bits)	0 - 105	SGPR 0 to 105	Scalar GPRs
	106	VCC_LO	Holds the low Dword of the vector condition code
	107	VCC_HI	Holds the high Dword of the vector condition code
	108-123	TTMP0 to TTMP15	Trap temps (privileged)
	124	M0	Misc register
	125	NULL	Reads return zero, writes are discarded.
	126	EXEC_LO	Execute mask, low Dword
	127	EXEC_HI	Execute mask, high Dword
	128	0	zero
	129-192	int 1 to 64	Positive integer values.
	193-208	int -1 to -16	Negative integer values.
	209-234	reserved	Unused.
	235	SHARED_BASE	Memory Aperture definition. Values are affected by system addressing mode: 32 or 64 bit.
	236	SHARED_LIMIT	
	237	PRIVATE_BASE	
	238	PRIVATE_LIMIT	
	239	POPS_EXITING_WAVE_ID	Primitive Ordered Pixel Shading wave ID.



	Code	Meaning	Description
	240	0.5	single or double floats
	241	-0.5	
	242	1.0	
	243	-1.0	
	244	2.0	
	245	-2.0	
	246	4.0	
	247	-4.0	
	248	$1.0 / (2 * \text{PI})$	
	249-250	reserved	unused
	251	VCCZ	{ zeros, VCCZ }
	252	EXECZ	{ zeros, EXECZ }
	253	SCC	{ zeros, SCC }
	254	reserved	unused
	255	Literal	constant 32-bit constant from instruction stream.

The SALU cannot use VGPRs or LDS. SALU instructions can use a 32-bit literal constant. This constant is part of the instruction stream and is available to all SALU microcode formats except SOPP and SOPK. Literal constants are used by setting the source instruction field to "literal" (255), and then the following instruction dword is used as the source value.

If the destination SGPR is out-of-range, no SGPR is written with the result. However, SCC and possibly EXEC (if saveexec) is still written.

If an instruction uses 64-bit data in SGPRs, the SGPR pair must be aligned to an even boundary. For example, it is legal to use SGPRs 2 and 3 or 8 and 9 (but not 11 and 12) to represent 64-bit data.

## 5.3. Scalar Condition Code (SCC)

The scalar condition code (SCC) is written as a result of executing most SALU instructions.

The SCC is set by many instructions:

- Compare operations: 1 = true.
- Arithmetic operations: 1 = carry out.
  - SCC = overflow for signed add and subtract operations. For add, overflow = both operands are of the same sign, and the MSB (sign bit) of the result is different than the sign of the operands. For subtract (AB), overflow = A and B have opposite signs and

the resulting sign is not the same as the sign of A.

- Bit/logical operations: 1 = result was not zero.

## 5.4. Integer Arithmetic Instructions

This section describes the arithmetic operations supplied by the SALU. The table below shows the scalar integer arithmetic instructions:

Table 11. Integer Arithmetic Instructions

Instruction	Encoding	Sets SCC?	Operation
S_ADD_I32	SOP2	y	$D = S0 + S1$ , SCC = overflow.
S_ADD_U32	SOP2	y	$D = S0 + S1$ , SCC = carry out.
S_ADDC_U32	SOP2	y	$D = S0 + S1 + SCC = \text{overflow}$ .
S_SUB_I32	SOP2	y	$D = S0 - S1$ , SCC = overflow.
S_SUB_U32	SOP2	y	$D = S0 - S1$ , SCC = carry out.
S_SUBB_U32	SOP2	y	$D = S0 - S1 - SCC = \text{carry out}$ .
S_ABSDIFF_I32	SOP2	y	$D = \text{abs}(S0 - S1)$ , SCC = result not zero.
S_MIN_I32 S_MIN_U32	SOP2	y	$D = (S0 < S1) ? S0 : S1$ . SCC = 1 if S0 was min.
S_MAX_I32 S_MAX_U32	SOP2	y	$D = (S0 > S1) ? S0 : S1$ . SCC = 1 if S0 was max.
S_MUL_I32	SOP2	n	$D = S0 * S1$ . Low 32 bits of result.
S_ADDK_I32	SOPK	y	$D = D + \text{simm16}$ , SCC = overflow. Sign extended version of simm16.
S_MULK_I32	SOPK	n	$D = D * \text{simm16}$ . Return low 32bits. Sign extended version of simm16.
S_ABS_I32	SOP1	y	$D.i = \text{abs}(S0.i)$ . SCC=result not zero.
S_SEXT_I32_I8	SOP1	n	$D = \{ 24\{S0[7]\}, S0[7:0] \}$ .
S_SEXT_I32_I16	SOP1	n	$D = \{ 16\{S0[15]\}, S0[15:0] \}$ .

## 5.5. Conditional Instructions

Conditional instructions use the SCC flag to determine whether to perform the operation, or (for CSELECT) which source operand to use.

Table 12. Conditional Instructions

Instruction	Encoding	Sets SCC?	Operation
S_CSELECT_{B32, B64}	SOP2	n	$D = SCC ? S0 : S1$ .

Instruction	Encoding	Sets SCC?	Operation
S_CMOVK_I32	SOPK	n	if (SCC) D = signext(simm16).
S_CMOV_{B32,B64}	SOP1	n	if (SCC) D = S0, else NOP.

## 5.6. Comparison Instructions

These instructions compare two values and set the SCC to 1 if the comparison yielded a TRUE result.

Table 13. Conditional Instructions

Instruction	Encoding	Sets SCC?	Operation
S_CMP_EQ_U64, S_CMP_LG_U64	SOPC	y	Compare two 64-bit source values. SCC = S0 <cond> S1.
S_CMP_{EQ,LG,GT,GE,LE,LT}_ {I32,U32}	SOPC	y	Compare two source values. SCC = S0 <cond> S1.
S_CMPK_{EQ,LG,GT,GE,LE,LT}_ {I32,U32}	SOPK	y	Compare Dest SGPR to a constant. SCC = DST <cond> simm16. simm16 is zero-extended (U32) or sign-extended (I32).
S_BITCMP0_{B32,B64}	SOPC	y	Test for "is a bit zero". SCC = !S0[S1].
S_BITCMP1_{B32,B64}	SOPC	y	Test for "is a bit one". SCC = S0[S1].

## 5.7. Bit-Wise Instructions

Bit-wise instructions operate on 32- or 64-bit data without interpreting it has having a type. For bit-wise operations if noted in the table below, SCC is set if the result is nonzero.

Table 14. Bit-Wise Instructions

Instruction	Encoding	Sets SCC?	Operation
S_MOV_{B32,B64}	SOP1	n	D = S0
S_MOVEZ_I32	SOPK	n	D = signext(simm16)
{S_AND,S_OR,S_XOR}_{B32,B64}	SOP2	y	D = S0 & S1, S0 OR S1, S0 XOR S1
{S_ANDN2,S_ORN2}_{B32,B64}	SOP2	y	D = S0 & ~S1, S0 OR ~S1, S0 XOR ~S1,
{S_NAND,S_NOR,S_XNOR}_{B32,B64}	SOP2	y	D = ~(S0 & S1), ~(S0 OR S1), ~(S0 XOR S1)
S_LSHL_{B32,B64}	SOP2	y	D = S0 << S1[4:0], [5:0] for B64.
S_LSHR_{B32,B64}	SOP2	y	D = S0 >> S1[4:0], [5:0] for B64.
S_ASHR_{I32,I64}	SOP2	y	D = sext(S0 >> S1[4:0]) ([5:0] for I64).

Instruction	Encoding	Sets SCC?	Operation
S_BFM_{B32,B64}	SOP2	n	Bit field mask. $D = ((1 \ll S0[4:0]) - 1) \ll S1[4:0]$ .
S_BFE_U32, S_BFE_U64 S_BFE_I32, S_BFE_I64 (signed/unsigned)	SOP2	y	Bit Field Extract, then sign-extend result for I32/64 instructions. S0 = data, S1[5:0] = offset, S1[22:16]= width.
S_NOT_{B32,B64}	SOP1	y	$D = \sim S0$ .
S_WQM_{B32,B64}	SOP1	y	$D = \text{wholeQuadMode}(S0)$ . If any bit in a group of four is set to 1, set the resulting group of four bits all to 1.
S_QUADMASK_{B32,B64}	SOP1	y	$D[0] = \text{OR}(S0[3:0])$ , $D[1]=\text{OR}(S0[7:4])$ , etc.
S_BITREPLICATE_B64_B32	SOP1	n	Replicate each bit in 32-bit S0 twice: $D = \{ \dots S0[1], S0[1], S0[0], S0[0] \}$ . Two of these instructions is the inverse of S_QUADMASK.
S_BREV_{B32,B64}	SOP1	n	$D = S0[0:31]$ are reverse bits.
S_BCNT0_I32_{B32,B64}	SOP1	y	$D = \text{CountZeroBits}(S0)$ .
S_BCNT1_I32_{B32,B64}	SOP1	y	$D = \text{CountOneBits}(S0)$ .
S_FF0_I32_{B32,B64}	SOP1	n	$D =$ Bit position of first zero in S0 starting from LSB. -1 if not found.
S_FF1_I32_{B32,B64}	SOP1	n	$D =$ Bit position of first one in S0 starting from LSB. -1 if not found.
S_FLBIT_I32_{B32,B64}	SOP1	n	Find last bit. $D =$ the number of zeros before the first one starting from the MSB. Returns -1 if none.
S_FLBIT_I32 S_FLBIT_I32_I64	SOP1	n	Count how many bits in a row (from MSB to LSB) are the same as the sign bit. Return -1 if the input is zero or all 1's (-1). 32-bit pseudo-code: if (S0 == 0    S0 == -1) D = -1 else D = 0 for (I = 31 .. 0) if (S0[I] == S0[31]) D++ else break This opcode behaves the same as V_FFBH_I32.
S_BITSET0_{B32,B64}	SOP1	n	$D[S0[4:0], [5:0]$ for B64] = 0
S_BITSET1_{B32,B64}	SOP1	n	$D[S0[4:0], [5:0]$ for B64] = 1
S_{and,or,xor,andn1,andn2,orn1,orn2,n and, nor,xnor}_SAVEEXEC_{B32,B64}	SOP1	y	Save the EXEC mask, then apply a bit-wise operation to it. $D = \text{EXEC}$ $\text{EXEC} = S0 \langle \text{op} \rangle \text{EXEC}$ $\text{SCC} = (\text{exec} \neq 0)$

Instruction	Encoding	Sets SCC?	Operation
S_{ANDN{1,2}_WREXEC_B}{32,64}	SOP1	y	N1: EXEC, D = ~S0 & EXEC N2: EXEC, D = S0 & ~EXEC Both D and EXEC get the same result. SCC = (result != 0).
S_MOVRELS_{B32,B64} S_MOVRELD_{B32,B64}	SOP1	n	Move a value into an SGPR relative to the value in M0. MOVERELS: D = SGPR[S0+M0] MOVERELD: SGPR[D+M0] = S0 Index must be even for 64. M0 is an unsigned index.

## 5.8. Access Instructions

These instructions access hardware internal registers.

Table 15. Hardware Internal Registers

Instruction	Encoding	Sets SCC?	Operation
S_GETREG_B32	SOPK*	n	Read a hardware register into the LSBs of D.
S_SETREG_B32	SOPK*	n	Write the LSBs of D into a hardware register. (Note that D is a source SGPR.) Must add an S_NOP between two consecutive S_SETREG to the same register.
S_SETREG_IMM32_B32	SOPK*	n	S_SETREG where 32-bit data comes from a literal constant (so this is a 64-bit instruction format).
S_ROUND_MODE	SOPP	n	Set the round mode from an immediate: simm16[3:0]
S_DENORM_MODE	SOPP	n	Set the denorm mode from an immediate: simm16[3:0]

The hardware register is specified in the DEST field of the instruction, using the values in the table above. Some bits of the DEST specify which register to read/write, but additional bits specify which bits in the register to read/write:

```
SIMM16 = {size[4:0], offset[4:0], hwRegId[5:0]}; offset is 0..31, size is 1..32.
```

Table 16. Hardware Register Values

Code	Register	Description
0	reserved	
1	MODE	R/W.
2	STATUS	Read only.
3	TRAPSTS	R/W.

Code	Register	Description
5	GPR_ALLOC	Read only. {sgpr_size, sgpr_base, vgpr_size, vgpr_base }.
6	LDS_ALLOC	Read only. {lds_size, lds_base}.
7	IB_STS	Read only. {valu_cnt, lgkm_cnt, exp_cnt, vm_cnt}.
8 - 14		reserved.
15	SH_MEM_BASES	Bits [15:0] = Private Base; [31:16] = Shared Base.
16	TBA_LO	Trap base address register [31:0].
17	TBA_HI	Trap base address register [47:32].
18	TMA_LO	Trap memory address register [31:0].
19	TMA_HI	Trap memory address register [47:32].
20	FLAT_SCRATCH_LO	Flat Scratch memory address, bits [31:0]
21	FLAT_SCRATCH_HI	Flat Scratch memory address, bits [63:32]
25	POPS_PACKER	Bit [0] = POPS enabled for this wave; bits [2:1] = Pops Packer ID
29	SHADER_CYCLES	Return the value of a 20-bit clock cycle counter. Used for measuring time-delta within a wave, not between waves.

Table 17. IB\_STS

Code	Register	Description
VM_CNT	23:22, 3:0	Number of VMEM load instructions issued but not yet returned.
EXP_CNT	6:4	Number of Exports issued but have not yet read their data from VGPRs.
LGKM_CNT	11:8	LDS, GDS, Constant-memory and Message instructions issued-but-not-completed count.
VS_CNT	31:26	Number of VMEM store instructions issued but not yet returned.

Table 18. GPR\_ALLOC

Code	Register	Description
VGPR_BASE	5:0	Physical address of first VGPR assigned to this wavefront, as [7:2]
VGPR_SIZE	13:8	Number of VGPRs assigned to this wavefront, as [7:2]+4. 0=4 VGPRs, 1=8 VGPRs, etc.

Table 19. LDS\_ALLOC

Code	Register	Description
LDS_BASE	7:0	Physical address of first LDS location assigned to this wavefront, in units of 64 Dwords.
LDS_SIZE	20:12	Amount of LDS space assigned to this wavefront, in units of 64 Dwords.

Code	Register	Description
VGPR_SHARED_SIZE	27:24	Number of shared VGPRs allocate to this wave, in units of 8 VGPRs. (0=0vgprs, 1=8vgprs, ...)

# Chapter 6. Vector ALU Operations

Vector ALU instructions (VALU) perform an arithmetic or logical operation on data for each of 32 or 64 threads and write results back to VGPRs, SGPRs or the EXEC mask.

Parameter interpolation is a mixed VALU and LDS instruction, and is described in the Data Share chapter.

## 6.1. Microcode Encodings

Most VALU instructions are available in two encodings: VOP3 which uses 64-bits of instruction, and one of three 32-bit encodings that offer a restricted set of capabilities. A few instructions are only available in the VOP3 encoding.

When an instruction is available in two microcode formats, it is up to the user to decide which to use. It is recommended to use the 32-bit encoding whenever possible.

The microcode encodings are shown below:

**VOP2** is for instructions with two inputs and a single vector destination. Instructions that have a carry-out implicitly write the carry-out to the VCC register.



**VOP1** is for instructions with no inputs or a single input and one destination.



**VOPC** is for comparison instructions.



**VINTRP** is for parameter interpolation instructions.





**VOP3** is for instructions with up to three inputs, input modifiers (negate and absolute value), and output modifiers. There are two forms of VOP3: one which uses a scalar destination field (used only for div\_scale, integer add and subtract); this is designated VOP3b. All other instructions use the common form, designated VOP3a.

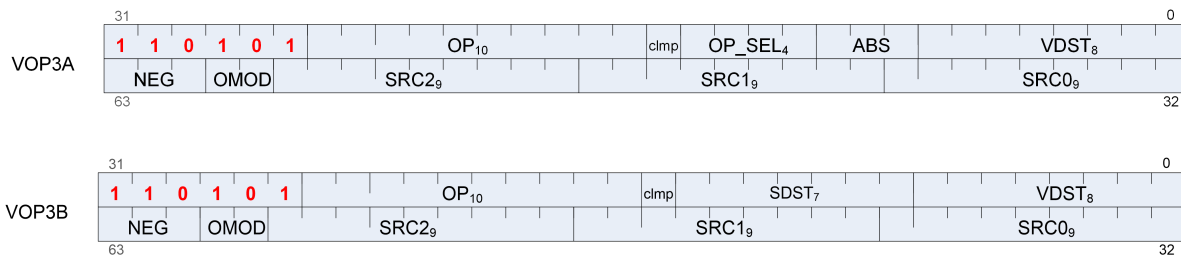

Any of the 32-bit microcode formats may use a 32-bit literal constant, as well VOP3. Note however that VOP3 plus a literal makes a 96-bit instruction and excessive use of this combination may reduce performance.

**VOP3P** is for instructions that use "packed math": These instructions perform an operation on a pair of input values that are packed into the high and low 16-bits of each operand; the two 16-bit results are written to a single VGPR as two packed values.

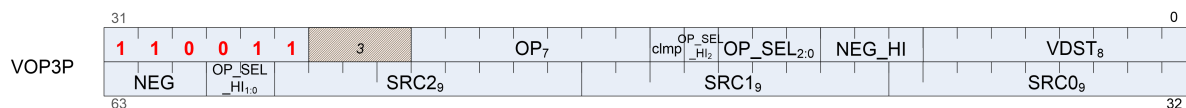

## 6.2. Operands

All VALU instructions take at least one input operand (except V\_NOP and V\_CLREXCP). The data-size of the operands is explicitly defined in the name of the instruction. For example, V\_FMA\_F32 operates on 32-bit floating point data.

Table 20. Instruction Operands

Value	Name	Description
0-105	SGPR	0 .. 105
106	VCC_LO	vcc[31:0].
107	VCC_HI	vcc[63:32].
108-123	TTMP0 to TTMP 15	Trap handler temps (privileged).
124	M0	M0 register
125	NULL	Reads return zero, writes are discarded.
126	EXEC_LO	exec[31:0].
127	EXEC_HI	exec[63:32].
128	0	Zero

Value	Name	Description
129-192	int 1.. 64	Integer inline constants.
193-208	int -1 .. -16	
209-232	reserved	Unused.
233	DPP8	DPP - 8 lane transfer. (only valid as source-0)
234	DPP8FI	DPP - 8 lane transfer with fetch from invalid lanes. (only valid as source-0)
235	SHARED_BASE	Memory Aperture definition.
236	SHARED_LIMIT	
237	PRIVATE_BASE	
238	PRIVATE_LIMIT	
239	POPS_EXITING_WAVE_ID	Primitive Ordered Pixel Shading wave ID.
240	0.5	Single, double, or half-precision inline floats.  1/(2*PI) is 0.15915494. The exact value used is: half: 0x3118 single: 0x3e22f983 double: 0x3fc45f306dc9c882
241	-0.5	
242	1.0	
243	-1.0	
244	2.0	
245	-2.0	
246	4.0	
247	-4.0	
248	1/(2*PI)	
249	SDWA	
250	DPP16	DPP over 16 lanes (only valid as Source-0)
251	VCCZ	{ zeros, VCCZ }
252	EXECZ	{ zeros, EXECZ }
253	SCC	{ zeros, SCC }
254	LDS direct	Use LDS direct read to supply 32-bit value Vector-alu instructions only.
255	Literal	constant 32-bit constant from instruction stream.
256-511	VGPR	0 .. 255

### 6.2.1. Instruction Inputs

VALU instructions can use any of the following sources for input, subject to restrictions listed below:

- VGPRs

- SGPRs
- Inline constants - constant selected by a specific VSRC value
- Literal constant - 32-bit value in the instruction stream.
- LDS direct data read
- M0
- EXEC mask

### Limitations

- At most two scalar values can be read per instructions, but the values can be used for more than one operand.
  - Scalar values include: SGPRs, VCC, EXEC (used as data), and literal constants
  - Some instructions implicitly read an SGPR (which includes VCC), and this implicit read counts against the total supported limit.
    - These are: Add/sub with carry-in, FMAS and CNDMASK
  - 64-bit shift instructions can use only a single scalar value, not two
- At most one literal constant can be used
- Inline constants are free, and do not count against these limits
- Only SRC0 can use LDS\_DIRECT (see Chapter 10, "Data Share Operations")

Instructions using the VOP3 form and also using floating-point inputs have the option of applying absolute value (ABS field) or negate (NEG field) to any of the input operands.

### Literal Expansion to 64 bits

Literal constants are 32-bits, but they can be used as sources which normally require 64-bit data. They are expanded to 64 bits following these rules:

- 64 bit float: the lower 32-bit are padded with zero.
- 64-bit unsigned integer: zero extended to 64 bits
- 64-bit signed integer: sign extended to 64 bits

## 6.2.2. Instruction Outputs

VALU instructions typically write their results to VGPRs specified in the VDST field of the microcode word. A thread only writes a result if the associated bit in the EXEC mask is set to 1.

All V\_CMPX instructions write the result of their comparison (one bit per thread) the EXEC mask.

Instructions producing a carry-out (integer add and subtract) write their result to VCC when used in the VOP2 form, and to an arbitrary SGPR-pair when used in the VOP3 form.

When the VOP3 form is used, instructions with a floating-point result can apply an output modifier (OMOD field) that multiplies the result by: 0.5, 1.0, 2.0 or 4.0. Optionally, the result can be clamped (CLAMP field) to the range [0.0, +1.0].

Output modifiers apply only to floating point results and are ignored for integer or bit results. Output modifiers are not compatible with output denormals: if output denormals are enabled, then output modifiers are ignored. If output denormals are disabled, then the output modifier is applied and denormals are flushed to zero. Output modifiers are not IEEE compatible: -0 is flushed to +0. Output modifiers are ignored if the IEEE mode bit is set to 1.

In the table below, all codes can be used when the vector source is nine bits; codes 0 to 255 can be the scalar source if it is eight bits; codes 0 to 127 can be the scalar source if it is seven bits; and codes 256 to 511 can be the vector source or destination.

### 6.2.3. Wave64 use of SGPRs

VALU instructions may use SGPRs as a uniform input, shared by all workitems. If the value is used as simple data value, then the same SGPR is distributed to all 64 workitems. If, on the other hand, the data value represents a mask (e.g. carry-in, mask for CNDMASK), then each workitem receives a separate value, and two consecutive SGPRs are read.

### 6.2.4. Wave64 Destination Restrictions

When a VALU instruction is issued from a wave64, it is actually issued twice as two wave32 instructions. While in most cases the programmer need not be aware of these, it does impose a prohibition on wave64 VALU instructions which both write and read the same SGPR value. Doing this may lead to unpredictable results. *Specifically, the first pass of a wave64 VALU instruction may not overwrite a scalar value used by the second half.*

### 6.2.5. OPSEL Field Restrictions

The OPSEL field (of VOP3) is usable only for a subset of VOP3 instructions, and not for VOP1, VOP2 or VOPC instructions using the VOP3 encoding (these should use SDWA instead).

Table 21. Opcodes usable with OPSEL

V_MAD_I16	V_INTERP_P2_F16	V_ADD_NC_U16
V_FMA_F16	V_CVT_PKNORM_I16_F16	V_SUB_NC_U16
V_ALIGNBIT_B32	V_CVT_PKNORM_U16_F16	V_MUL_L0_U16
V_ALIGNBYTE_B32	V_MAD_U32_U16	V_LSHLREV_B16
V_DIV_FIXUP_F16	V_MAD_I32_I16	V_LSHRREV_B16
	V_MIN3_{F16, I16, U16}	V_ASHRREV_I16
	V_MAX3_{F16, I16, U16}	V_MAX_U16

	V_MED3_{F16, I16, U16}	V_MAX_I16
	V_PACK_F16	V_MIN_U16
		V_MIN_I16

## 6.2.6. Out-of-Range GPRs

When a source VGPR is out-of-range, the instruction uses as input the value from VGPR0.

When the destination GPR is out-of-range, the instruction executes but does not write the results.

## 6.3. Instructions

The table below lists the complete VALU instruction set by microcode encoding, except for VOP3P instructions which are listed in a later section.

Table 22. VALU Instruction Set

VOP3	VOP3 – 1-2 operand opcodes	VOP2	VOP1
V_ADD_LSHL_U32	One Operand:	V_ADD_{F16, F32}	V_BFREV_B32
V_ADD3_U32	V_LDEXP_F32	V_ADD_CO_CI_U32	V_CEIL_{ F16, F32, F64}
V_ALIGNBIT_B32	V_LDEXP_F64	V_ADD_NC_U32	V_CLREXCP
V_ALIGNBYTE_B32		V_AND_B32	V_COS_{ F16, F32}
V_AND_OR_B32	Two Operands:	V_ASHRREV_B32	V_CVT_{I32, U32, F16, F64}_F32
V_BFE_{U32 , I32 }	V_ADD_CO_U32	V_CNDMASK_B32	V_CVT_{I32, U32}_F64
V_BFI_B32	V_ADD_F64	V_CVT_PKRTZ_F16_F32	V_CVT_{U16, I16}_F16
V_CUBEID_F32	V_ADD_NC_{I32, U16, I16}	V_FMAAK_F16	V_CVT_F16_{U16, I16}
V_CUBEMA_F32	V_ASHRREV_{I16, I64}	V_FMAAK_F32	V_CVT_F32_{I32, U32, F16, F64}
V_CUBESC_F32	V_BCNT_U32_B32	V_FMAC_F16	V_CVT_F32_UBYTE{0, 1, 2, 3 }
V_CUBETC_F32	V_BFM_B32	V_FMAC_F32	V_CVT_F64_{I32, U32}
V_CVT_PK_U8_F32	V_CVT_PK_{I16, U16}_U32	V_FMAMK_F16	V_CVT_FLR_I32_F32
V_DIV_FIXUP_{ F16, F32, F64}	V_CVT_PKNORM_{I16, U16}_F16	V_FMAMK_F32	V_CVT_NORM_I16_F16
V_DIV_FMAS_{F32, F64}	V_CVT_PKNORM_{I16, U16}_F32	V_LDEXP_F16	V_CVT_NORM_U16_F16
V_DIV_SCALE_{F32, F64}	V_INTERP_MOV_F32	V_LSHLREV_B32	V_CVT_OFF_F32_I4
V_FMA_{ F16, F32, F64}	V_INTERP_P1_F32	V_LSHRREV_B32	V_CVT_RPI_I32_F32
V_LERP_U8	V_INTERP_P1LL_F16	V_MAC_{ F16, F32}	V_EXP_{ F16, F32}
V_LSHL_ADD_U32	V_INTERP_P1LV_F16		V_FFBH_{U32, I32}

VOP3	VOP3 – 1-2 operand opcodes	VOP2	VOP1
V_LSHL_OR_B32	V_INTERP_P2_F16		V_FFBL_B32
V_MAD_{I16,U16}	V_INTERP_P2_F32		V_FLOOR_{ F16,F32, F64}
V_MAD_{U64_U32, I64_I32}	V_LSHLREV_{B16, B64}	V_MAX_{ F16, F32, I32, U32}	V_FRACT_{ F16, F32, F64}
V_MAD_I32_I16	V_LSHRREV_{B16, B64}	V_MIN_{ F16, F32, I32, U32}	V_FREXP_EXP_I16_F16
V_MAD_I32_I24	V_MAX_{U16, I16, F64}	V_MUL_{F16, F32}	V_FREXP_EXP_I32_F32
	V_MBCNT_HI_U32_B32	V_MUL_HI_I32_I24	V_FREXP_EXP_I32_F64
V_MAD_U32_U16	V_MBCNT_LO_U32_B32	V_MUL_HI_U32_U24	V_FREXP_MANT_{ F16, F32, F64}
V_MAD_U32_U24	V_MIN_{ U16, I16, F64}	V_MUL_I32_I24	V_LOG_{ F16, F32}
V_MAX3_{F16, I16, U16}	V_MUL_F64	V_MUL_LEGACY_F32	V_MOV_B32
V_MAX3_{F32, I32, U32}	V_MUL_HI_{I32, U32}	V_MUL_U32_U24	V_MOV_FED_B32
V_MED3_{F16, I16, U16}	V_MUL_LO_{U16, U32}	V_OR_B32	V_MOVREL{S, D, SD, SD_2}_B32
V_MED3_{F32, I32, U32}	V_PACK_B32_F16	V_SUB_{F16, F32}	V_NOP
V_MIN3_{F16, I16, U16}	V_READLANE_B32	V_SUB_CO_CI_U32	V_NOT_B32
V_MIN3_{F32, I32, U32}	V_SUB_CO_U32	V_SUB_NC_U32	V_PIPEFLUSH
V_MQSAD_PK_U16_U8	V_SUB_NC_{I32, U16, I16}	V_SUBREV_{F16, F32}	V_RCP_{ F16, F32, F64}
V_MQSAD_PK_U32_U8	V_SUBREV_CO_U32	V_SUBREV_CO_CI_U32	V_RCP_IFLAG_F32
V_MSAD_U8	V_WRITELANE_B32	V_SUBREV_NC_U32	V_READFIRSTLANE_B32
V_MULLIT_F32		V_XNOR_B32	V_RNDNE_{ F16, F32, F64}
V_OR3_B32		V_XOR_B32	V_RSQ_{ F16, F32, F64}
V_PERM_B32			V_SAT_PK_U8_I16
V_PERMLANE16_B32			V_SIN_{ F16, F32}
V_PERMLANEX16_B32			V_SQRT_{ F16, F32, F64}
V_QSAD_PK_U16_U8			V_SWAP_B32
V_SAD_{U8, HI_U8, U16, U32}			V_SWAPREL_B32
V_TRIG_PREOP_F64			V_TRUNC_{ F16, F32, F64}
V_XAD_U32			
V_XOR3_B32			
VOP3P:		V_DOT2C_F32_F16	
V_DOT2_F32_F16		V_DOT4C_I32_I8	
V_DOT2_I32_I16			
V_DOT2_U32_U16			
V_DOT4_I32_I8			
V_DOT4_U32_U8			
V_DOT8_I32_I4			

<b>VOP3</b>	<b>VOP3 – 1-2 operand opcodes</b>	<b>VOP2</b>	<b>VOP1</b>
V_D0T8_U32_U4			

The next table lists the compare instructions.

Table 23. VALU Compare Instruction Set

Op	Formats	Functions	Result
V_CMP	I16, I32, I64, U16, U32, U64	F, LT, EQ, LE, GT, LG, GE, T	Write VCC..
V_CMPX			Write exec.
V_CMP	F16, F32, F64	F, LT, EQ, LE, GT, LG, GE, T, O, U, NGE, NLG, NGT, NLE, NEQ, NLT (o = total order, u = unordered, N = NaN or normal compare)	Write VCC.
V_CMPX			Write exec.
V_CMP_CLASS	F16, F32, F64	Test for one of: signaling-NaN, quiet-NaN, positive or negative: infinity, normal, subnormal, zero.	Write VCC.
V_CMPX_CLASS			Write exec.

## 6.4. Denormalized and Rounding Modes

The shader program has explicit control over the rounding mode applied and the handling of denormalized inputs and results. The MODE register is set using the S\_SETREG instruction; it has separate bits for controlling the behavior of single and double-precision floating-point numbers.

Round and denormal modes can also be set using S\_ROUND\_MODE and S\_DENORM\_MODE.

Table 24. Round and Denormal Modes

Field	Bit Position	Description
FP_ROUND	3:0	[1:0] Single-precision round mode. [3:2] Double/Half-precision round mode. Round Modes: 0=nearest even; 1= +infinity; 2= -infinity, 3= toward zero.
FP_DENORM	7:4	[5:4] Single-precision denormal mode. [7:6] Double/Half-precision denormal mode. Denormal modes: 0 = Flush input and output denorms. 1 = Allow input denorms, flush output denorms. 2 = Flush input denorms, allow output denorms. 3 = Allow input and output denorms.

## 6.5. ALU Clamp Bit Usage

The clamp bit has multiple uses. For V\_CMP instructions, setting the clamp bit to 1 indicates that the compare signals if a floating point exception occurs. For integer operations, it clamps the result to the largest and smallest representable value. For floating point operations, it clamps the result to the range: [0.0, 1.0].

## 6.6. VGPR Indexing

VGPR indexing allows a value stored in the M0 register to act as an index into the VGPRs for either the source operand, destination or both for certain MOVE operations.

The table below describes the instructions which enable, disable and control VGPR indexing.

Table 25. VGPR Indexing Instructions

Instruction	Encoding	Operation
V_MOVRELD_B32	VOP1	Move with relative destination: $VGPR[D+M0] = VGPR[S0]$ .
V_MOVRELS_B32	VOP1	Move with relative source: $VGPR[D] = VGPR[S0+M0]$ .
V_MOVRELSD_B32	VOP1	Move with relative source and destination: $VGPR[D+M0] = VGPR[S0+M0]$ .
V_MOVRELSD_2_B32	VOP1	Move with relative source and destination, each different: $VGPR[D+M0[25:16]] = VGPR[S0+M0[7:0]]$ .
V_SWAPREL_B32	VOP1	Swap two VGPRs, each relative to a separate index: swap $VGPR[D+M0[25:16]]$ with $VGPR[S0+M0[7:0]]$ .

## 6.7. Packed Math

**Packed math** is a form of operation which accelerates arithmetic on two values packed into the same VGPR. It performs operations on two 16-bit values within a DWORD as if they were separate threads. For example, a packed add of  $V0=V1+V2$  is really two separate adds: adding the low 16 bits of each Dword and storing the result in the low 16 bits of V0, and adding the high halves and storing the result in the high 16 bits of V0.

Packed math uses the instructions below and the microcode format "VOP3P". This format adds op\_sel and neg fields for both the low and high operands, and removes ABS and OMOD.

Table 26. Packed Math Opcodes:

V_PK_MAD_I16	V_PK_MUL_LO_U16	V_PK_ADD_I16	V_PK_SUB_I16
V_PK_LSHLREV_B16	V_PK_LSHRREV_B16	V_PK_ASHRREV_I16	V_PK_MAX_I16
V_PK_MIN_I16	V_PK_MAD_U16	V_PK_ADD_U16	V_PK_SUB_U16



V_PK_MAX_U16	V_PK_MIN_U16	V_PK_FMA_F16	V_PK_ADD_F16
V_PK_MUL_F16	V_PK_MIN_F16	V_PK_MAX_F16	V_FMA_MIX_F32



V\_FMA\_MIX\_\* are not packed math, but perform a single MAD operation on a mixture of 16- and 32-bit inputs. They are listed here because they use the VOP3P encoding.

## 6.8. Sub-Dword Addressing (SDWA)

Sub DWord Addressing allows a VOP1, VOP2 and VOPC instruction to reference 16 bits of data in a 32-bit VGPR either the upper or lower half, or any of 4 bytes in the DWORD. The actual SRC0 operand will be supplied by the SRC0 field of the SDWA word. Each operand can select the high or low 16-bits or any byte as the destination portion of a VGPR. SDWA is indicated by setting the SRC0 to the inline constant: SQ\_SRC\_SDWA. VOPC instructions use a slightly different version of the SDWA instruction word which as “SD” and “SDST” fields, but not: OMOD, CLMP, DST\_U and DST\_SEL.

## 6.9. Data Parallel Processing (DPP)

Data Parallel ALU operations allow VALU instruction to select operands from different lanes (threads) rather than just using a thread’s own lane. DPP is compatible only with: VOP1 and VOP2. There are no new instructions, but there are two new instruction formats in the form of an extra DWORD of instruction: DPP8 or DPP16.

There are two forms of the DPP instruction word:

**DPP8** allows arbitrary swizzling between groups of 8 lanes

**DPP16** allows a set of predefined swizzles between groups of 16 lanes

A scan operation is one which computes a value per thread which is based on the values of the previous threads and possibly itself. E.g. a running sum is the sum of the values from previous threads in the vector. A reduction operation is essentially a scan which returns a single value from the highest numbered active thread. These operations take the SP multiple instruction cycles (at least 8 times what an ADD\_F32 takes). Rather than make these a single macro in SQ, the shader program will have unique instructions for each pass of the scan. This prevents any instruction scheduling issues (any other waves may execute in between these individual stage instruction) and allows more general flexibility.

Use of DPP is indicated by setting the SRC0 operand to a literal constant: DPP8 or DPP16. Note that since SRC-0 is set to the literal value, the actual VGPR address for Source-0 comes

from the literal constant (DPP). The scan operation requires the EXEC mask to be set to all 1's for proper operation. Unused threads (lanes) should be set to a value which will not change the result prior to the scan. Readlane, readfirstlane and writelane cannot be used with DPP.

## 6.10. PERMLANE Specific Rules

V\_PERMLANE may not occur immediately after a V\_CMPX. To prevent this, any other VALU opcode may be inserted (e.g. v\_mov\_b32 v0, v0).

# Chapter 7. Scalar Memory Operations

Scalar Memory Read (SMEM) instructions allow a shader program to load data from memory into SGPRs through the Scalar Data Cache. Instructions can read from 1 to 16 Dwords. Data is read directly into SGPRs without any format conversion.

The scalar unit reads consecutive Dwords from memory to the SGPRs. This is intended primarily for loading ALU constants and for indirect T#/S# lookup. No data formatting is supported, nor is byte or short data.

## 7.1. Microcode Encoding

Scalar memory read instructions are encoded using the SMEM microcode format.

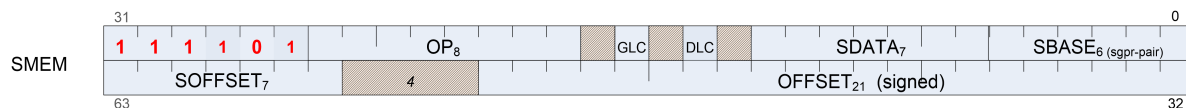

The fields are described in the table below:

Table 27. SMEM Encoding Field Descriptions

Field	Size	Description
OP	8	Opcode.
GLC	1	Globally Coherent. Controls L1 cache policy: 0=hit_lru, 1=miss_evict.
DLC	1	Device Coherent. "1" indicates to bypass the GL1 cache.
SDATA	7	SGPRs to return read data to. Reads of two Dwords must have an even SDST-sgpr. Reads of four or more Dwords must have their DST-gpr aligned to a multiple of 4. SDATA must be: SGPR or VCC. Not: exec or m0.
SBASE	6	SGPR-pair (SBASE has an implied LSB of zero) which provides a base address, or for BUFFER instructions, a set of 4 SGPRs (4-sgpr aligned) which hold the resource constant. For BUFFER instructions, the only resource fields used are: base, stride, num_records.
OFFSET	21	An immediate signed byte offset. Must be positive with s_buffer operations.
SOFFSET	7	The address of an SGPR which supplies an unsigned byte address offset. Set this to NULL to disable.

## 7.2. Operations

### 7.2.1. S\_LOAD\_DWORD

These instructions load 1-16 Dwords from memory. The data in SGPRs is specified in SDATA, and the address is composed of the SBASE, OFFSET, and SOFFSET fields.

#### Scalar Memory Addressing

S\_LOAD :

$$\text{ADDR} = \text{SGPR}[\text{base}] + \text{inst\_offset} + \{ \text{M0 or SGPR}[\text{offset}] \text{ or zero } \}$$

All components of the address (base, offset, inst\_offset, M0) are in bytes, but the two LSBs are ignored and treated as if they were zero.

It is illegal and undefined if the inst\_offset is negative and the resulting (inst\_offset + (M0 or SGPR[offset])) is negative.

Scalar access to private (scratch) space must either use a buffer constant or manually convert the address.

#### Reads using Buffer Constant

Buffer constant fields used: base\_address, stride, num\_records. Other fields are ignored.

Scalar memory read does not support "swizzled" buffers. **Stride** is used only for memory address bounds checking, not for computing the address to access.

The SMEM supplies only a SBASE address (byte) and an offset (byte or Dword). Any "index \* stride" must be calculated manually in shader code and added to the offset prior to the SMEM.

The two LSBs of V#.base and of the final address are ignored to force Dword alignment.

```
"m_#" components come from the buffer constant (V#):
offset    = OFFSET + SOFFSET (M0, SGPR or zero)
m_base    = { SGPR[SBASE * 2 + 1][15:0], SGPR[SBASE*2] }
m_stride  = SGPR[SBASE * 2 + 1][31:16]
m_num_records = SGPR[SBASE * 2 + 2]
m_size    = (m_stride == 0) ? 1 : m_num_records
addr      = (m_base + offset) & ~0x3
SGPR[SDST] = read_Dword_from_dcache(addr, m_size)
```

If more than 1 dword is being read, it is returned to SDST+1, SDST+2, etc, and the offset is incremented by 4 bytes per DWORD.

### 7.2.2. S\_DCACHE\_INV

This instruction invalidates the entire scalar cache. It does not return anything to SDST.

### 7.2.3. S\_MEMREALTIME

This instruction reads a 64-bit "real time-counter" and returns the value into a pair of SGPRs: SDST and SDST+1. The time value is from a clock for which the frequency is constant (not affected by power modes or core clock frequency changes).

## 7.3. Dependency Checking

Scalar memory reads can return data out-of-order from how they were issued; they can return partial results at different times when the read crosses two cache lines. The shader program uses the LGKM\_CNT counter to determine when the data has been returned to the SDST SGPRs. This is done as follows.

- LGKM\_CNT is incremented by 1 for every fetch of a single Dword.
- LGKM\_CNT is incremented by 2 for every fetch of two or more Dwords.
- LGKM\_CNT is decremented by an equal amount when each instruction completes.

Because the instructions can return out-of-order, the only sensible way to use this counter is to implement S\_WAITCNT 0; this imposes a wait for all data to return from previous SMEMs before continuing.

## 7.4. Scalar Memory Clauses and Groups

A **clause** is a sequence of instructions starting with S\_CLAUSE and continuing for 2-63 instructions. Clauses lock the instruction arbiter onto this wave until the clause completes.

A **group** is a set of the same type of instruction that happen to occur in the code but are not necessarily executed as a clause. A group ends when a non-SMEM instruction is encountered. Scalar memory instructions are issued in groups. The hardware does not enforce that a single wave will execute an entire group before issuing instructions from another wave.

### Group restrictions:

1. INV must be in a group by itself
2. "TIME" instructions are considered as reads for group rules

### Instruction ordering

The data cache is free to re-order instructions. The only assurance of ordering comes when the shader executes an S\_WAITCNT LGKMcnt==0. Cache invalidate instructions are not assured to

have completed until the shader waits for `LGKMcnt==0`.

## 7.5. Alignment and Bounds Checking

### SDST

The value of SDST must be even for fetches of two Dwords, or a multiple of four for larger fetches. If this rule is not followed, invalid data can result. If SDST is out-of-range, the instruction is not executed.

### SBASE

The value of SBASE must be even for `S_BUFFER_LOAD` (specifying the address of an SGPR which is a multiple of four). If SBASE is out-of-range, the value from SGPR0 is used.

### OFFSET

The value of OFFSET has no alignment restrictions.

**Memory Address** : If the memory address is out-of-range (clamped), the operation is not performed for any Dwords that are out-of-range.

## Chapter 8. Vector Memory Operations

Vector Memory (VMEM) instructions read or write one piece of data separately for each work-item in a wavefront into, or out of, VGPRs. This is in contrast to Scalar Memory instructions, which move a single piece of data that is shared by all threads in the wavefront. All Vector Memory (VM) operations are processed by the texture cache system.

Software initiates a load, store or atomic operation through the texture cache through one of three types of VMEM instructions:

- MTBUF: Memory typed-buffer operations.
- MUBUF: Memory untyped-buffer operations.
- MIMG: Memory image operations.
- FLAT: Memory load/store/atomic on flat memory addresses (in subsequent chapter)
- GLOBAL: Memory load/store/atomic on simple address (in subsequent chapter)
- SCRATCH: Memory load/store/atomic to scratch memory (in subsequent chapter)

The instruction defines which VGPR(s) supply the addresses for the operation, which VGPRs supply or receive data from the operation, and a series of SGPRs that contain the memory buffer descriptor ( $V\#$  or  $T\#$ ). Also, MIMG operations supply a texture sampler ( $S\#$ ) from a series of four SGPRs; this sampler defines texel filtering operations to be performed on data read from the image.

### 8.1. Vector Memory Buffer Instructions

Vector-memory (VM) operations transfer data between the VGPRs and buffer objects in memory through the texture cache (TC). **Vector** means that one or more piece of data is transferred uniquely for every thread in the wavefront, in contrast to scalar memory reads, which transfer only one value that is shared by all threads in the wavefront.

Buffer reads have the option of returning data to VGPRs or directly into LDS.

Examples of buffer objects are vertex buffers, raw buffers, stream-out buffers, and structured buffers.

Buffer objects support both homogeneous and heterogeneous data, but no filtering of read-data (no samplers). Buffer instructions are divided into two groups:

- MUBUF: Untyped buffer objects.
  - Data format is specified in the resource constant.
  - Load, store, atomic operations, with or without data format conversion.
- MTBUF: Typed buffer objects.
  - Data format is specified in the instruction.

- The only operations are Load and Store, both with data format conversion.

Atomic operations take data from VGPRs and combine them arithmetically with data already in memory. Optionally, the value that was in memory before the operation took place can be returned to the shader.

All VM operations use a buffer resource constant (V#) which is a 128-bit value in SGPRs. This constant is sent to the texture cache when the instruction is executed. This constant defines the address and characteristics of the buffer in memory. Typically, these constants are fetched from memory using scalar memory reads prior to executing VM instructions, but these constants also can be generated within the shader.

### 8.1.1. Simplified Buffer Addressing

The equation below shows how the hardware calculates the memory address for a buffer access:

$$ADDR = \underset{V\#}{Base} + \underset{SGPR}{baseOffset} + \underset{Instr}{Inst\_offset} + \underset{VGPR}{Voffset} + \underset{V\#}{Stride} * (\underset{VGPR}{Vindex} + \underset{0..63}{TID})$$

Voffset is ignored when instruction bit "OFFEN" == 0

Vindex is ignored when instructino bit "IDXEN" == 0

TID is a constant value (0..63) unique to each thread in the wave. It is ignored when resource bit ADD\_TID\_ENABLE == 0

### 8.1.2. Buffer Instructions

Buffer instructions (MTBUF and MUBUF) allow the shader program to read from, and write to, linear buffers in memory. These operations can operate on data as small as one byte, and up to four Dwords per work-item. Atomic arithmetic operations are provided that can operate on the data values in memory and, optionally, return the value that was in memory before the arithmetic operation was performed.

The D16 instruction variants convert the results to packed 16-bit values. For example, BUFFER\_LOAD\_FORMAT\_D16\_XYZW writes two VGPRs.

Table 28. Buffer Instructions

Instruction	Description
MTBUF Instructions	
TBUFFER_LOAD_FORMAT_{x,xy,xyz,xyzw} TBUFFER_STORE_FORMAT_{x,xy,xyz,xyzw} TBUFFER_LOAD_FORMAT_D16_{x,xy,xyz,xyzw} TBUFFER_STORE_FORMAT_D16_{x,xy,xyz,xyzw}	Read from, or write to, a typed buffer object. Also used for a vertex fetch.
MUBUF Instructions	



Instruction	Description
BUFFER_LOAD_FORMAT_{x,xy,xyz,xyzw} BUFFER_STORE_FORMAT_{x,xy,xyz,xyzw} BUFFER_LOAD_FORMAT_D16_{x,xy,xyz,xyzw} BUFFER_STORE_FORMAT_D16_{x,xy,xyz,xyzw}	Read to, or write from, an untyped buffer object.
BUFFER_LOAD_{<size>}	<size> = byte, ubyte, short, ushort, Dword, Dwordx2, Dwordx3, Dwordx4
BUFFER_STORE_{<size>}	BUFFER_ATOMIC_{<op>}
	BUFFER_ATOMIC_{<op>}_x2

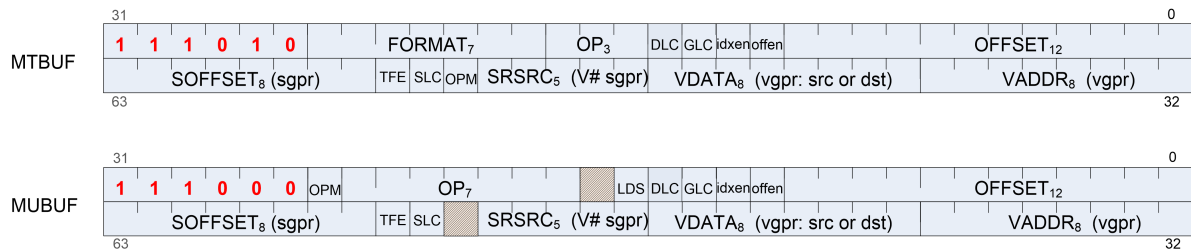

Table 29. Microcode Formats

Field	Bit Size	Description
OP	4 7	MTBUF: Opcode for Typed buffer instructions. MUBUF: Opcode for Untyped buffer instructions.
VADDR	8	Address of VGPR to supply first component of address (offset or index). When both index and offset are used, index is in the first VGPR, offset in the second.
VDATA	8	Address of VGPR to supply first component of write data or receive first component of read-data.
SOFFSET	8	SGPR to supply unsigned byte offset. SGPR, M0, or inline constant.
SRSRC	5	Specifies which SGPR supplies V# (resource constant) in four consecutive SGPRs. This field is missing the two LSBs of the SGPR address, since this address is be aligned to a multiple of four SGPRs.
FORMAT	7	Data Format of data in memory buffer. See: <a href="#">Buffer Image format Table</a>
OFFSET	12	Unsigned byte offset.
OFFEN	1	1 = Supply an offset from VGPR (VADDR). 0 = Do not (offset = 0).
IDXEN	1	1 = Supply an index from VGPR (VADDR). 0 = Do not (index = 0).
GLC	1	Globally Coherent. Controls how reads and writes are handled by the L0 texture cache. <b>READ</b> GLC = 0 Reads can hit on the L0 and persist across wavefronts GLC = 1 Reads miss the L0 and force fetch to L2. No L0 persistence across waves. <b>WRITE</b> GLC = 0 Writes miss the L0, write through to L2, and persist in L0 across wavefronts. GLC = 1 Writes miss the L0, write through to L2. No persistence across wavefronts. <b>ATOMIC</b> GLC = 0 Previous data value is not returned. No L0 persistence across wavefronts. GLC = 1 Previous data value is returned. No L0 persistence across wavefronts. Note: GLC means "return pre-op value" for atomics.
DLC	1	Device Level Coherent. When set, accesses are forced to miss in level 1
SLC	1	System Level Coherent. Used in conjunction with DLC to determine L2 cache policies.

Field	Bit Size	Description
TFE	1	Texel Fault Enable for PRT (partially resident textures). When set to 1 and fetch returns a NACK, status is written to the VGPR at DST+1 (first VGPR after all fetch-dest VGPRs).
LDS	1	MUBUF-ONLY: 0 = Return read-data to VGPRs. 1 = Return read-data to LDS instead of VGPRs.

### 8.1.3. VGPR Usage

VGPRs supply address and write-data; also, they can be the destination for return data (the other option is LDS).

#### Address

Zero, one or two VGPRs are used, depending of the offset-enable (OFFEN) and index-enable (IDXEN) in the instruction word, as shown in the table below:

Table 30. Address VGPRs

IDXEN	OFFEN	VGPRn	VGPRn+1
0	0	nothing	
0	1	uint offset	
1	0	uint index	
1	1	uint index	uint offset

**Write Data** : N consecutive VGPRs, starting at VDATA. The data format specified in the instruction word (FORMAT for MTBUF, or encoded in the opcode field for MUBUF) and D16 setting determines how many Dwords to write.

**Read Data** : Same as writes. Data is returned to consecutive VGPRs.

**Read Data Format** : Read data is 32 or 16 bits, based on the data format in the instruction or resource and D16. Float or normalized data is returned as floats; integer formats are returned as integers (signed or unsigned, same type as the memory storage format). Memory reads of data in memory that is 32 or 64 bits do not undergo any format conversion unless they return as 16-bit due to D16 being set.

**Atomics with Return** : Data is read out of the VGPR(s) starting at VDATA to supply to the atomic operation. If the atomic returns a value to VGPRs, that data is returned to those same VGPRs starting at VDATA.

### 8.1.4. Buffer Data

The amount and type of data that is read or written is controlled by the following: the resource format field, destination-component-selects (dst\_sel), and the opcode. FORMAT can come from

the resource, instruction fields, or the opcode itself. `Dst_sel` comes from the resource, but is ignored for many operations.

Table 31. Buffer Instructions

Instruction	Data Format	DST SEL
TBUFFER_LOAD_FORMAT_*	instruction	identity
TBUFFER_STORE_FORMAT_*	instruction	identity
BUFFER_LOAD_<type>	derived	identity
BUFFER_STORE_<type>	derived	identity
BUFFER_LOAD_FORMAT_*	resource	resource
BUFFER_STORE_FORMAT_*	resource	resource
BUFFER_ATOMIC_*	derived	identity

**Instruction** : The instruction's format field is used instead of the resource's fields.

**Data format derived** : The data format is derived from the opcode and ignores the resource definition. For example, `buffer_load_ubyte` sets the data-format to 8 to uint.



The resource's data format must not be INVALID; that format has specific meaning (unbound resource), and for that case the data format is not replaced by the instruction's implied data format.

**DST\_SEL identity** : Depending on the number of components in the data-format, this is: X000, XY00, XYZ0, or XYZW.

The MTBUF derives the data format from the instruction. The MUBUF `BUFFER_LOAD_FORMAT` and `BUFFER_STORE_FORMAT` instructions use **format** from the resource; other MUBUF instructions derive data-format from the instruction itself.

**D16 Instructions** : Load-format and store-format instructions also come in a "d16" variant. For stores, each 32-bit VGPR holds two 16-bit data elements that are passed to the texture unit. This texture unit converts them to the texture format before writing to memory. For loads, data returned from the texture unit is converted to 16 bits, and a pair of data are stored in each 32-bit VGPR (LSBs first, then MSBs). Control over int vs. float is controlled by `FORMAT`.

### 8.1.5. Buffer Addressing

A **buffer** is a data structure in memory that is addressed with an **index** and an **offset**. The index points to a particular record of size **stride** bytes, and the offset is the byte-offset within the record. The **stride** comes from the resource, the index from a VGPR (or zero), and the offset from an SGPR or VGPR and also from the instruction itself.

Table 32. BUFFER Instruction Fields for Addressing

Field	Size	Description
inst_offset	12	Literal byte offset from the instruction.
inst_idxen	1	Boolean: get index from VGPR when true, or no index when false.
inst_offen	1	Boolean: get offset from VGPR when true, or no offset when false. Note that inst_offset is present, regardless of this bit.

The "element size" for a buffer instruction is the amount of data the instruction transfers, or the number of contiguous bytes of a record for a given index, and is fixed at 4 bytes.

Table 33. V# Buffer Resource Constant Fields for Addressing

Field	Size	Description
const_base	48	Base address, in bytes, of the buffer resource.
const_stride	14	Stride of the record in bytes (0 to 16,383 bytes, or 0 to 262,143 bytes).
const_num_records	32	Number of records in the buffer. In units of: Bytes if: const_stride == 0    or const_swizzle_enable == false  Otherwise, in units of "stride".
const_add_tid_enable	1	Boolean. Add thread_ID within the wavefront to the index when true.
const_swizzle_enable	1	Boolean. Indicates that the surface is swizzled when true.
const_index_stride	2	Used only when const_swizzle_en = true. Number of contiguous indices for a single element (of element_size) before switching to the next element. There are 8, 16, 32, or 64 indices.

Table 34. Address Components from GPRs

Field	Size	Description
SGPR_offset	32	An unsigned byte-offset to the address. Comes from an SGPR or M0.
VGPR_offset	32	An optional unsigned byte-offset. It is per-thread, and comes from a VGPR.
VGPR_index	32	An optional index value. It is per-thread and comes from a VGPR.

The final buffer memory address is composed of three parts:

- the base address from the buffer resource (V#),
- the offset from the SGPR, and
- a buffer-offset that is calculated differently, depending on whether the buffer is linearly addressed (a simple Array-of-Structures calculation) or is swizzled.

Address Calculation for a Linear Buffer

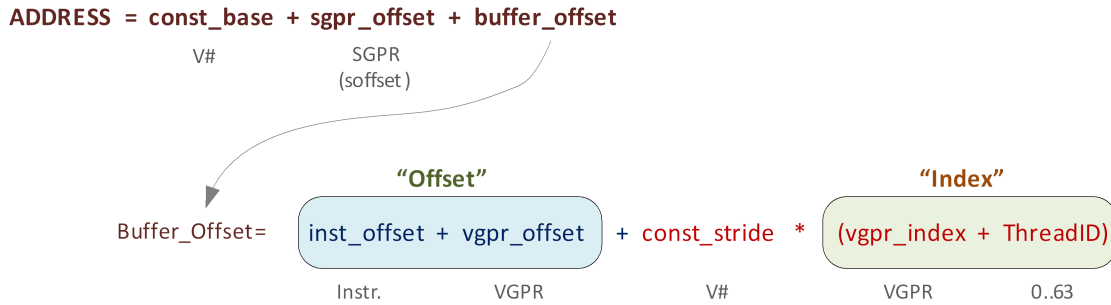

Full equations:

**Index** = (inst\_idxen ? vgpr\_index : 0) + (const\_add\_tid\_enable ? thread\_id[5:0] : 0)

**Offset** = (inst\_offen ? vgpr\_offset : 0) + inst\_offset

Figure 8. Address Calculation for a Linear Buffer

### Range Checking

Range checking determines if a given buffer memory address is in-range (valid) or out of range. When an address is out of range, writes are ignored (dropped) and reads return zero. Range checking is controlled by a 2-bit field in the buffer resource: OOB\_SELECT (Out of Bounds select).

Table 35. Buffer Out Of Bounds Selection

OOB SELECT	Out of Bounds Check	Description or use
0	(index >= NumRecords)   (offset >= stride)	structured buffers
1	(index >= NumRecords)	Raw buffers
2	(NumRecords == 0)	do not check bounds

OOB SELECT	Out of Bounds Check	Description or use
3	<p>Bounds check:</p> <pre data-bbox="321 306 1182 470"> if (swizzle_en &amp; const_stride != 0x0)     OOB = (index &gt;= NumRecords()    (offset+payload &gt; stride)) else     OOB = (offset+payload &gt; NumRecords) </pre> <p>Where "payload" is the number of dwords the instruction transfers.</p>	<p>Raw</p> <p>In this mode, "num_records" is reduced by "sgpr_offset"</p>

**Notes:**

1. Reads that go out-of-range return zero (except for components with V#.dst\_sel = SEL\_1 that return 1).
2. Writes that are out-of-range do not write anything.
3. Load/store-format-\* instruction and atomics are range-checked "all or nothing" - either entirely in or out.
4. Load/store-Dword-x{2,3,4} and range-check per component.

**Swizzled Buffer Addressing**

Swizzled addressing rearranges the data in the buffer which may improve performance for arrays of structures. Swizzled addressing also requires Dword-aligned accesses. The buffer's STRIDE must be a multiple of element\_size.

```

Index = (inst_idxen ? vgpr_index : 0) +
        (const_add_tid_enable ? thread_id[5:0] : 0)

Offset = (inst_offen ? vgpr_offset : 0) + inst_offset

index_msb = index / const_index_stride
index_lsb = index % const_index_stride
offset_msb = offset / element_size
offset_lsb = offset % element_size

buffer_offset = (index_msb * const_stride + offset_msb *
                element_size) * const_index_stride + index_lsb *
                element_size + offset_lsb

Final Address = const_base + sgpr_offset + buffer_offset

```

Remember that the "sgpr\_offset" is not a part of the "offset" term in the above equations.

### Original Buffer

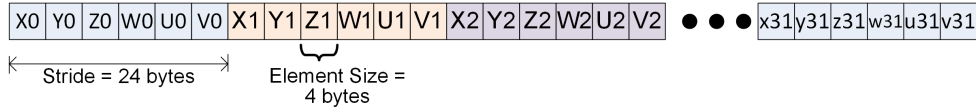

### Swizzled Buffer

```
const_index_stride = 8 // how many consecutive indices to group together
const_element_size = 4 bytes // the size of a single element, in bytes
```

```
index_msb = index / const_index_stride
index_lsb = index % const_index_stride
offset_msb = offset / const_element_size
offset_lsb = offset % const_element_size
```

$$\text{Buffer\_offset} = (\text{index\_msb} * \text{const\_stride} + \text{offset\_msb} * \text{const\_element\_size}) * \text{const\_index\_stride} + \text{index\_lsb} * \text{const\_element\_size} + \text{offset\_lsb}$$

which simplifies to...

$$\text{Buffer\_offset} = (\text{index}/8 * \text{const\_stride} + (\text{offset}/4)*4) * 8 + \text{index}\%8 * 4 + \text{offset}\%4$$

*Note that because we are dealing with dwords, offset%4 is always == 0.*

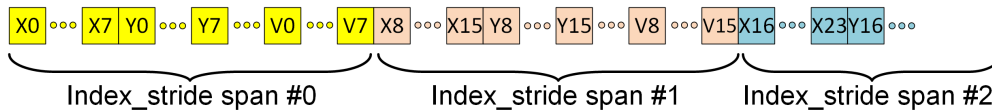

### An alternate way to visualize Swizzled Buffers

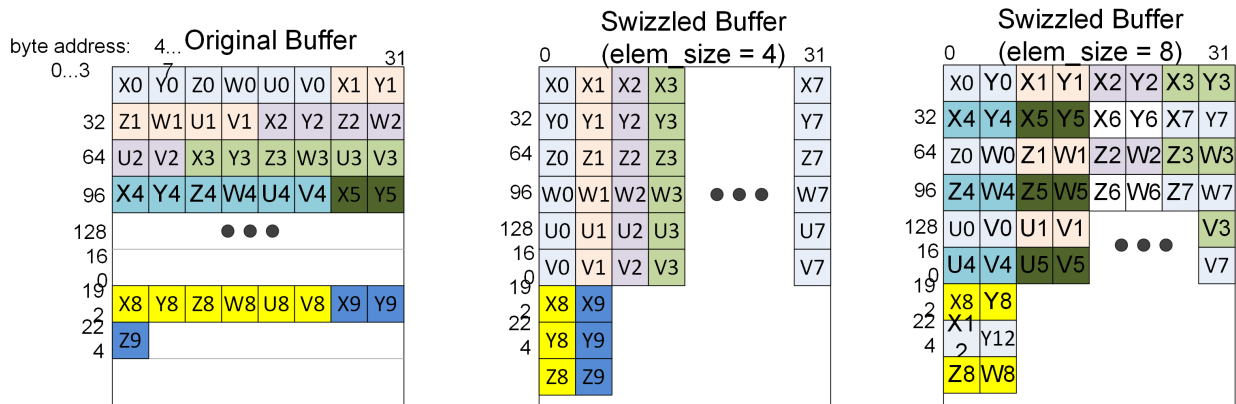

Figure 9. Example of Buffer Swizzling

### Proposed Use Cases for Swizzled Addressing

Here are few proposed uses of swizzled addressing in common graphics buffers.

Table 36. Swizzled Buffer Use Cases

	DX11 Raw Uav OpenCL Buffer Object	Dx11 Structured (literal offset)	Dx11 Structured (gpr offset)	Scratch	Ring / stream-out	Const Buffer
inst_vgpr_offset_en	T	F	T	T	T	T
inst_vgpr_index_en	F	T	T	F	F	F
const_stride	na	<api>	<api>	scratchSize	na	na
const_add_tid_enable	F	F	F	T	T	F
const_buffer_swizzle	F	T	T	T	F	F

### 8.1.6. 16-bit Memory Operations

The D16 buffer instructions allow a kernel to load or store just 16 bits per work item between VGPRs and memory. There are two variants of these instructions:

- D16 loads data into or stores data from the lower 16 bits of a VGPR.
- D16\_HI loads data into or stores data from the upper 16 bits of a VGPR.

For example, BUFFER\_LOAD\_UBYTE\_D16 reads a byte per work-item from memory, converts it to a 16-bit integer, then loads it into the lower 16 bits of the data VGPR.

### 8.1.7. Alignment

Formatted ops such as BUFFER\_LOAD\_FORMAT\_\* must always be aligned to element\_size.

For Dword or larger reads or writes of non-formatted ops (such as BUFFER\_LOAD\_DWORD), the two LSBs of the byte-address are ignored, thus forcing Dword alignment.

Memory alignment enforcement for non-formatted ops is controlled by a configuration register: SH\_MEM\_CONFIG.alignment\_mode.

- DWORD: Automatic alignment to multiple of the smaller of element size or a dword.
- DWORD\_STRICT: Require alignment to multiple of the smaller of element size or a dword.
- STRICT: Require alignment to multiple of element size.
- UNALIGNED: No alignment requirements.

### 8.1.8. Buffer Resource

The buffer resource describes the location of a buffer in memory and the format of the data in the buffer. It is specified in four consecutive SGPRs (four aligned SGPRs) and sent to the



texture cache with each buffer instruction.

The table below details the fields that make up the buffer resource descriptor.

*Table 37. Buffer Resource Descriptor*

Bits	Size	Name	Description
47:0	48	Base address	Byte address.
61:48	14	Stride	Bytes 0 to 16383
62	1	Cache swizzle	Buffer access. Optionally, swizzle texture cache TC L0 cache banks.
63	1	Swizzle enable	Swizzle AOS according to stride, index_stride, and element_size, else linear (stride * index + offset).
95:64	32	Num_records	In units of stride if (stride $\geq$ 1), else in bytes.
98:96	3	Dst_sel_x	Destination channel select: 0=0, 1=1, 4=R, 5=G, 6=B, 7=A
101:99	3	Dst_sel_y	
104:102	3	Dst_sel_z	
107:105	3	Dst_sel_w	
114:108	7	Format	Memory data type.
118:117	2	Index stride	0:8, 1:16, 2:32, or 3:64. Used for swizzled buffer addressing.
119	1	Add tid enable	Add thread ID to the index for to calculate the address.
120	1	Resource Level	Set to 1.
125:124	2	OOB_SELECT	Out of bounds select.
127:126	2	Type	Value == 0 for buffer. Overlaps upper two bits of four-bit TYPE field in 128-bit V# resource.

A resource set to all zeros acts as an unbound texture or buffer (return 0,0,0,0).

### 8.1.9. Memory Buffer Load to LDS

The MUBUF instruction format allows reading data from a memory buffer directly into LDS without passing through VGPRs. This is supported for the following subset of MUBUF instructions.

- BUFFER\_LOAD\_{ubyte, sbyte, ushort, sshort, dword, format\_x}.
- It is illegal to set the instruction's TFE bit for loads to LDS.

LDS\_offset = 16-bit unsigned byte offset from M0[15:0].

Mem\_offset = 32-bit unsigned byte offset from an SGPR (the SOFFSET SGPR).

idx\_vgpr = index value from a VGPR (located at VADDR). (Zero if idxen=0.)

off\_vgpr = offset value from a VGPR (located at VADDR or VADDR+1). (Zero if offen=0.)

The figure below shows the components of the LDS and memory address calculation:

$$\text{LDS\_ADDR} = \text{LDSbase} + \text{LDS\_offset} + \text{inst\_offset} + (\text{TIDinWave} * 4)$$

HW-Alloc
M0[15:0]
Instr.
0..63
bytes-per-dword

$$\text{MEM\_ADDR} = \text{Base} + \text{mem\_offset} + \text{inst\_offset} + \text{off\_vgpr} + \text{stride} * (\text{idx\_vgpr} + \text{TIDinWave})$$

T#
SGPR (soffset)
Instr.
VGPR
T#
VGPR
0..63

Zero – no vgpr
4 bytes
Zero

TIDinWave is only added if the resource (V#) has the ADD\_TID\_ENABLE field set to 1, whereas LDS adds it. The MEM\_ADDR M# is in the VDATA field; it specifies M0.

### Clamping Rules

Memory address clamping follows the same rules as any other buffer fetch. LDS address clamping: the return data cannot be written outside the LDS space allocated to this wave.

- Set the active-mask to limit buffer reads to those threads that return data to a legal LDS location.
- The LDSbase (alloc) is in units of 32 Dwords, as is LDSsize.
- M0[15:0] is in bytes.

## 8.1.10. GLC, DLC and SLC Bits Explained

### GLC

The GLC bit means different things for loads, stores, and atomic ops.

#### GLC Meaning for Loads

- For GLC==0
  - The load can read data from the GPU L0.
  - Typically, all loads (except load-acquire) use GLC==0.
- For GLC==1
  - The load intentionally misses the GPU L0 and reads from L2. If there was a line in the GPU L0 that matched, it is invalidated; L2 is reread.
  - NOTE: L2 is not re-read for every work-item in the same wave-front for a single load instruction. For example: b=uav[N+tid] // assume this is a byte read w/ glc==1 and N is aligned to 64B In the above op, the first Tid of the wavefront brings in the line from L2 or beyond, and all 63 of the other Tids read from same cache line in the L0.

## GLC Meaning for Stores

For both  $GLC==0$  and  $GLC==1$ , write data are combined across work-items of the wavefront store clause which can contain multiple store ops; dirtied lines are written to the L2 cache automatically and invalidated.

## Atomics

- For  $GLC == 0$  No return data (this is "write-only" atomic op).
- For  $GLC == 1$  Returns previous value in memory (before the atomic operation).

## DLC and SLC

The Device Level Coherent bit (DLC) and System Level Coherent (SLC) bits control the behavior of the second and third level caches.

Table 38. Vector Load Operations

SLC	DLC	L2 Cache	L1 Cache
0	0	LRU	Hit LRU - reads can hit on previous data
0	1	LRU	Miss Evict - reads miss
1	0	Stream	Hit LRU
1	1	Hit No Allocate	Miss Evict

Table 39. Vector Store & Atomic Operations

SLC	DLC	L2 Cache
0	0	LRU
0	1	Bypass
1	0	Stream - Hit leaves line in cache but do not reset age.
1	1	Hit No Allocate

For stores and atomics, the L1 cache is bypassed (but is coherent).  
For stores the L0 cache is always Miss-Evict.

## 8.2. Vector Memory (VM) Image Instructions

Vector Memory (VM) operations transfer data between the VGPRs and memory through the texture cache (TC). Vector means the transfer of one or more pieces of data uniquely for every work-item in the wavefront. This is in contrast to scalar memory reads, which transfer only one value that is shared by all work-items in the wavefront.

Examples of image objects are texture maps and typed surfaces.

Image objects are accessed using from one to four dimensional addresses; they are composed of homogeneous data of one to four elements. These image objects are read from, or written to, using `IMAGE_*` or `SAMPLE_*` instructions, all of which use the MIMG instruction format. `IMAGE_LOAD` instructions read an element from the image buffer directly into VGPRs, and `SAMPLE` instructions use sampler constants (`S#`) and apply filtering to the data after it is read. `IMAGE_ATOMIC` instructions combine data from VGPRs with data already in memory, and optionally return the value that was in memory before the operation.

All VM operations use an image resource constant (`T#`) that is a 128-bit or 256-bit value in SGPRs. This constant is sent to the texture cache when the instruction is executed. This constant defines the address, data format, and characteristics of the surface in memory. Some image instructions also use a sampler constant that is a 128-bit constant in SGPRs. Typically, these constants are fetched from memory using scalar memory reads prior to executing VM instructions, but these constants can also be generated within the shader.

Texture fetch instructions have a data mask (`DMASK`) field. `DMASK` specifies how many data components it receives. If `DMASK` is less than the number of components in the texture, the texture unit only sends `DMASK` components, starting with R, then G, B, and A. If `DMASK` specifies more than the texture format specifies, the shader receives data based on `T#.dst_sel` for the missing components.

### 8.2.1. Image Instructions

This section describes the image instruction set, and the microcode fields available to those instructions.

Table 40. Image Instructions

MIMG	Description
<code>SAMPLE_*</code>	Read and filter data from an image object.
<code>GATHER_*</code>	Read up to four texels where each texel contains a single component of an image object data format. <i>It takes 4 instructions to read RGBA.</i>
<code>IMAGE_LOAD_&lt;op&gt;</code>	Read data from an image object using one of the following: <code>image_load</code> , <code>image_load_mip</code> , <code>image_load_{pck, pck_sgn, mip_pck, mip_pck_sgn}</code> .
<code>IMAGE_STORE</code>	Store data to an image object using one of the following: <code>image_store</code> , <code>image_store_mip</code> , <code>image_store_pck</code> , <code>image_store_mip_pck</code> .
<code>IMAGE_ATOMIC_&lt;op&gt;</code>	Image atomic operation, which is one of the following: <code>swap</code> , <code>cmpswap</code> , <code>add</code> , <code>sub</code> , <code>umin</code> , <code>smin</code> , <code>umax</code> , <code>smax</code> , <code>and</code> , <code>or</code> , <code>xor</code> , <code>inc</code> , <code>dec</code> , <code>fcmpswap</code> , <code>fmin</code> , <code>fmax</code> .
<code>GET_RESINFO</code>	Return resource information

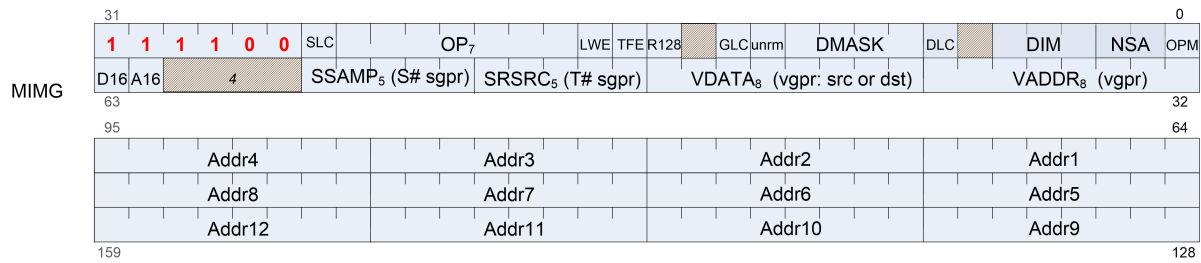

Table 41. Instruction Fields

Field	Bit Size	Description
OP	8	Opcode. Formed by joining the OPM and OP fields together.
NSA	2	Number of additional dwords of instruction: 0 - 3. 0 = instruction is 2 dwords in total; 3 = instruction is 5 dwords in total. Values other than zero imply the "MIMG-NSA" usage of addressing VGPRs.
VADDR	8	Address of VGPR to supply first component of address.
ADDR1 - ADDR12	8	12 additional VGPR address fields, used by the MIMG-NSA format. (VADDR acts as ADDR0).
VDATA	8	Address of VGPR to supply first component of write data or receive first component of read-data.
SSAMP	5	SGPR to supply S# (sampler constant) in four consecutive SGPRs. Missing two LSBs of SGPR-address since it is aligned to a multiple of four SGPRs.
SRSRC	5	SGPR to supply T# (resource constant) in four or eight consecutive SGPRs. Missing two LSBs of SGPR-address since it is aligned to a multiple of four SGPRs.
UNRM	1	Force address to be un-normalized regardless of T#. Set to 1 for image loads, stores and atomics.
R128	1	Texture buffer resource size: 0 = 256 bits, 1 = 128 bits.
DIM	3	Specifies the dimension of the surface: 0: 1D 1: 2D 2: 3D 3: Cube 4: 1D-array 5: 2D-array 6: 2D-msaa 7: 2D-msaa-array
DMASK	4	Data VGPR enable mask: one to four consecutive VGPRs. Reads: defines which components are returned. DMASK[0] = red, DMASK[1] = green, DMASK[2] = blue, DMASK[2] = alpha For example: dst_sel=unity, DMASK=0110 writes green to VGPRn and blue to VGPRn+1. D16 packs two components into one VGPR, so the example above would return 1 VGPR with green in VGPRn[15:0] and blue into VGPRn[31:16]. Writes: defines which components are written with data from VGPRs (missing components get 0). Enabled components come from consecutive VGPRs. For example: DMASK=1001: Red is in VGPRn and alpha in VGPRn+1. For D16 writes, two components' data are packed into one VGPR, so for this example Red ata comes from VGPRn[15:0] and alpha data from VGPRn[31:16].

Field	Bit Size	Description
GLC	1	Globally Coherent. Controls how reads and writes are handled by the L0 texture cache. <b>READ:</b> GLC = 0 Reads can hit on the L0 and persist across waves. GLC = 1 Reads miss the L0 and force fetch to L2. No L0 persistence across waves. <b>WRITE:</b> GLC = 0 Writes miss the L0, write through to L2, and persist in L0 across wavefronts. GLC = 1 Writes miss the L0, write through to L2. No persistence across wavefronts. <b>ATOMIC:</b> GLC = 0 Previous data value is not returned. No L0 persistence across wavefronts. GLC = 1 Previous data value is returned. No L0 persistence across wavefronts.
DLC	1	Device Level Coherent. When set, accesses are forced to miss in level 1 texture cache.
SLC	1	System Level Coherent. Used in conjunction with DLC to determine L2 cache policies.
TFE	1	Texel Fault Enable for PRT (partially resident textures). When set to 1 and fetch returns a NACK, status is written to the VGPR at DST+1 (first VGPR after all fetch-dest VGPRs).
LWE	1	LOD Warning Enable. When set to 1, a texture fetch may return "LOD_CLAMPED = 1".
A16	1	When set, all address components are 16-bit UINT for image ops without sampler; 16-bit float for image ops with sampler. Address components are packed two per VGPR except for texel offset where one VGPR contains three 6bit uint offsets. PCF reference (for _C instructions) ignores this field and is 32bit.
D16	1	VGPR-Data-16bit. On loads, convert data in memory to 16-bit format before storing it in VGPRs (2 16bit values per VGPR). For stores, convert 16-bit data in VGPRs to memory data format before writing to memory. Whether the data is treated as float or int is decided by format. Allowed only with these opcodes: IMAGE_SAMPLE* IMAGE_GATHER4* IMAGE_LOAD IMAGE_LOAD_MIP IMAGE_STORE IMAGE_STORE_MIP

### 8.2.2. Image Non-Sequential Address (NSA)

To avoid having many move instructions to pack image address VGPRs together, MIMG supports a "Non Sequential Address" version of the instruction where the VGPR of every address component is uniquely defined. *Data components are still packed.* This new format creates a larger instruction word, which can be up to 5 dwords long. The first address goes in the VADDR field, and subsequent addresses go into ADDR1-12. The 3 dword form of the instruction can supply up to 5 addresses; the 4 dword form 9 addresses and the 5 dword form 13 addresses which is the maximum any texture instruction can require.

When using 16-bit addresses, each VGPR holds a pair of addresses and these cannot be located in different VGPRs.

### 8.2.3. Image Opcodes with No Sampler

For image opcodes with no sampler, all VGPR address values are taken as uint. For cubemaps,  $\text{face\_id} = \text{slice} * 6 + \text{face}$ .

The table below shows the contents of address VGPRs for the various image opcodes.

Table 42. Image Opcodes with No Sampler

Image Opcode (Resource w/o Sampler)	Acnt	dim	VGPRn	VGPRn+1	VGPRn+2	VGPRn+3
get_resinfo	0	Any	mipid			
load / store / atomics	0	1D	x			
	1	1D Array	x	slice		
	1	2D	x	y		
	2	2D MSAA	x	y	fragid	
	2	2D Array	x	y	slice	
	3	2D Array MSAA	x	y	slice	fragid
	2	3D	x	y	z	
	2	Cube	x	y	face_id	
load_mip / store_mip	1	1D	x	mipid		
	2	1D Array	x	slice	mipid	
	2	2D	x	y	mipid	
	3	2D Array	x	y	slice	mipid
	3	3D	x	y	z	mipid
	3	Cube	x	y	face_id	mipid

### 8.2.4. Image Opcodes with a Sampler

For image opcodes with a sampler, all VGPR address values are taken as float. For cubemaps,  $\text{face\_id} = \text{slice} * 8 + \text{face}$ .

Certain sample and gather opcodes require additional values from VGPRs beyond what is shown. These values are: offset, bias, z-compare, and gradients.

Table 43. Image Opcodes with Sampler

Image Opcode (w/ Sampler)	Acnt	dim	VGPRn	VGPRn+1	VGPRn+2	VGPRn+3
sample	0	1D	x			
	1	1D Array	x	slice		
	1	2D	x	y		
	2	2D interlaced	x	y	field	
	2	2D Array	x	y	slice	
	2	3D	x	y	z	
	2	Cube	x	y	face_id	
sample_l	1	1D	x	lod		
	2	1D Array	x	slice	lod	
	2	2D	x	y	lod	
	3	2D interlaced	x	y	field	lod
	3	2D Array	x	y	slice	lod
	3	3D	x	y	z	lod
	3	Cube	x	y	face_id	lod
sample_cl	1	1D	x	clamp		
	2	1D Array	x	slice	clamp	
	2	2D	x	y	clamp	
	3	2D interlaced	x	y	field	clamp
	3	2D Array	x	y	slice	clamp
	3	3D	x	y	z	clamp
	3	Cube	x	y	face_id	clamp
gather4	1	2D	x	y		
	2	2D interlaced	x	y	field	
	2	2D Array	x	y	slice	
	2	Cube	x	y	face_id	
gather4_l	2	2D	x	y	lod	
	3	2D interlaced	x	y	field	lod
	3	2D Array	x	y	slice	lod
	3	Cube	x	y	face_id	lod
gather4_cl	2	2D	x	y	clamp	
	3	2D interlaced	x	y	field	clamp
	3	2D Array	x	y	slice	clamp
	3	Cube	x	y	face_id	clamp



1. Sample includes sample, sample\_d, sample\_b, sample\_lz, sample\_c, sample\_c\_d, sample\_c\_b, sample\_c\_lz, and getlod.
2. Sample\_l includes sample\_l and sample\_c\_l.
3. Sample\_cl includes sample\_cl, sample\_d\_cl, sample\_b\_cl, sample\_c\_cl, sample\_c\_d\_cl, and sample\_c\_b\_cl.
4. Gather4 includes gather4, gather4\_lz, gather4\_c, and gather4\_c\_lz.

The table below lists and briefly describes the legal suffixes for image instructions:

*Table 44. Sample Instruction Suffix Key*

Suffix	Meaning	Extra Addresses	Description
_L	LOD	-	LOD is used instead of computed LOD.
_B	LOD BIAS	1: lod bias	Add this BIAS to the LOD computed.
_CL	LOD CLAMP	-	Clamp the computed LOD to be no larger than this value.
_D	Derivative	2,4 or 6: slopes	Send dx/dv, dx/dy, etc. slopes to be used in LOD computation.
_LZ	Level 0	-	Force use of MIP level 0.
_C	PCF	1: z-comp	Percentage closer filtering.
_O	Offset	1: offsets	Send X, Y, Z integer offsets (packed into 1 Dword) to offset XYZ address.

### 8.2.5. VGPR Usage

Address: The address consists of up to four parts:

{ offset } { bias } { z-compare } { derivative } { body }

These are all packed into consecutive VGPRs.

- Offset: SAMPLE\*O\*, GATHER\*O\*  
One Dword of offset\_xyz. The offsets are six-bit signed integers: X=[5:0], Y=[13:8], and Z=[21:16].
- Bias: SAMPLE\*B\*, GATHER\*B\*. One Dword float.
- Z-compare: SAMPLE\*C\*, GATHER\*C\*. One Dword.
- Derivatives (sample\_d): 2, 4, or 6 Dwords, packed one Dword per derivative as:

Image Dim	Vgpr N	N+1	N+2	N+3	N+4	N+5
1D	DX/DH	DX/DV	-	-	-	-
2D	DX/DH	DY/DH	DX/DV	DY/DV	-	-
3D	DX/DH	DY/DH	DZ/DH	DX/DV	DY/DV	DZ/DV

- **Body:** One to four Dwords, as defined by the table: [\[Image Opcodes with Sampler\]](#) Address components are X,Y,Z,W with X in VGPR\_M, Y in VGPR\_M+1, etc. The number of components in "body" is the value of the ACNT field in the table, plus one.
- **Data:** Written from, or returned to, one to four consecutive VGPRs. The amount of data read or written is determined by the DMASK field of the instruction.
- **Reads:** DMASK specifies which elements of the resource are returned to consecutive VGPRs. The texture system reads data from memory and based on the data format expands it to a canonical RGBA form, filling in zero or one for missing components. Then, DMASK is applied, and only those components selected are returned to the shader.
- **Writes:** When writing an image object, it is only possible to write an entire element (all components), not just individual components. The components come from consecutive VGPRs, and the texture system fills in the value zero for any missing components of the image's data format; it ignores any values that are not part of the stored data format. For example, if the DMASK=1001, the shader sends Red from VGPR\_N, and Alpha from VGPR\_N+1, to the texture unit. If the image object is RGB, the texel is overwritten with Red from the VGPR\_N, Green and Blue set to zero, and Alpha from the shader ignored.
- **Atomics:** Image atomic operations are supported only on 32- and 64-bit-per pixel surfaces. The surface data format is specified in the resource constant. Atomic operations treat the element as a single component of 32- or 64-bits. For atomic operations, DMASK is set to the number of VGPRs (Dwords) to send to the texture unit. DMASK legal values for atomic image operations: no other values of DMASK are legal.
  - 0x1 = 32-bit atomics except cmpswap.
  - 0x3 = 32-bit atomic cmpswap.
  - 0x3 = 64-bit atomics except cmpswap.
  - 0xf = 64-bit atomic cmpswap.
- **Atomics with Return:** Data is read out of the VGPR(s), starting at VDATA, to supply to the atomic operation. If the atomic returns a value to VGPRs, that data is returned to those same VGPRs starting at VDATA.

## D16 Instructions

Load-format and store-format instructions also come in a "d16" variant. For stores, each 32-bit VGPR holds two 16-bit data elements that are passed to the texture unit. The texture unit converts them to the texture format before writing to memory. For loads, data returned from the texture unit is converted to 16 bits, and a pair of data are stored in each 32-bit VGPR (LSBs first, then MSBs). The DMASK bit represents individual 16-bit elements; so, when DMASK=0011 for an image-load, two 16-bit components are loaded into a single 32-bit VGPR.

## A16 Instructions

The **A16** instruction bit indicates that the address components are 16 bits instead of the usual 32 bits. Components are packed such that the first address component goes into the low 16 bits ([15:0]), and the next into the high 16 bits ([31:16]).

## 8.2.6. Image Resource

The image resource (also referred to as T#) defines the location of the image buffer in memory, its dimensions, tiling, and data format. These resources are stored in four or eight consecutive SGPRs and are read by MIMG instructions. All undefined or reserved bit must be set to zero unless otherwise specified.

Table 45. Image Resource Definition

Bits	Size	Name	Comments
<b>128-bit Resource: 1D-tex, 2d-tex, 2d-msaa (multi-sample anti-aliasing)</b>			
39:0	40	base address	256-byte aligned (represents bits 47:8). Also used for fmask-ptr.
51:40	12	min lod	4.8 (four uint bits, eight fraction bits) format.
60:52	9	format	Memory Data format
77:62	16	width	width-1 of mip 0 in texels (2 MSBs must be set to zero)
93:78	16	height	height-1 of mip 0 in texels (2 MSBs must be set to zero)
95	1	Resource level	Set to 1.
98:96	3	dst_sel_x	0 = 0, 1 = 1, 4 = R, 5 = G, 6 = B, 7 = A.
101:99	3	dst_sel_y	
104:102	3	dst_sel_z	
107:105	3	dst_sel_w	
111:108	4	base level	largest mip level in the resource view. For MSAA, this should be set to 0
115:112	4	last level	smallest mip level in resource view. For MSAA, holds log2(number of samples).
120:116	5	SW mode	swizzling (tiling) mode
123:121	3	BC Swizzle	Specifies channel ordering for border color data independent of the T# dst_sel_*s. Internal xyzw channels get the following border color channels as stored in memory. 0=xyzw, 1=xwyz, 2=wzyx, 3=wxyz, 4=zyxw, 5=yxwz
127:124	4	type	0 = buf, 8 = 1d, 9 = 2d, 10 = 3d, 11 = cube, 12 = 1d-array, 13 = 2d-array, 14 = 2d-msaa, 15 = 2d-msaa-array. 1-7 are reserved.
<b>256-bit Resource: 1d-array, 2d-array, 3d, cubemap, MSAA</b>			
140:128	13	depth	Depth-1 of Mip0 for a 3D map; last array slice for a 2D-array or 1D-array or cube-map.
141	1	Pitch[13]	(pitch-1)[13] of mip0 for 1D, 2D and 2D-MSAA.
156:144	13	base array	First slice in array of the resource view.

Bits	Size	Name	Comments
163:160	4	array pitch	For Arrays, array pitch for quilts, encoded as $\text{trunc}(\log_2(\text{array pitch}))+1$ . values 8..15 reserved For 3D, bit 0 indicates SRV or UAV: 0: SRV (base_array ignored, depth w.r.t. base map) 1: UAV (base_array and depth are first and last layer in view, and w.r.t. mip level specified)
167:164	14	max mip	Resource MipLevels-1. Describes the resource, as opposed to base-level and last-level which describes the resource-view. For MSAA, holds the number of samples.
179:168	12	min lod warn	feedback trigger for LOD
182:180	3	perf mod	scales sampler's perf Z, perf mip, aniso-bias, lod-bias-sec
183	1	corner samples mod	Describes how texels were generated in the resource. 0=center sampled, 1 = corner sampled.
201:200	2	LLC No-alloc	0: NoAlloc = PTE.NoAlloc 1: NoAlloc = Read ? PTE.NoAlloc : 1 2: NoAlloc = Read ? 1 : 0 3: NoAlloc = Read ? 1
202	1	Iterate 256	Indicates that compressed tiles in this surface have been flushed out to every 256B of the tile. Only applies to MSAA depth surfaces.
208:207	2	Max Uncompressed block size	Maximum uncompressed block size used for compressed shader writes
210:209	2	Max Compressed block size	Maximum compressed block size used for compressed shader writes
211	1	Meta Pipe Aligned	Maintains pipe alignment in metadata addressing (DCC and tiling)
212	1	Write compression enable	Enable compressed writes from shader
213	1	Compression Enable	enable delta color compression (DCC)
214	1	Alpha is on MSB	Set to 1 if the surface's component swap is not reversed (DCC)
215	1	Color Transform	Auto=0, none=1 (DCC)
255:216	40	Meta Data Address	Upper bits of meta-data address (DCC) [47:8]

### 8.2.7. Image Sampler

The sampler resource (also referred to as  $S\#$ ) defines what operations to perform on texture map data read by **sample** instructions. These are primarily address clamping and filter options. Sampler resources are defined in four consecutive SGPRs and are supplied to the texture cache with every sample instruction.

Table 46. Image Sampler Definition

Bits	Size	Name	Description
2:0	3	clamp x	Clamp/wrap mode: 0: Wrap 1: Mirror
5:3	3	clamp y	2: ClampLastTexel 3: MirrorOnceLastTexel 4: ClampHalfBorder
8:6	3	clamp z	5: MirrorOnceHalfBorder 6: ClampBorder 7: MirrorOnceBorder
11:9	3	max aniso ratio	0 = 1:1 1 = 2:1 2 = 4:1 3 = 8:1 4 = 16:1
14:12	3	depth compare func	0: Never 1: Less 2: Equal 3: Less than or equal 4: Greater 5: Not equal 6: Greater than or equal 7: Always
15	1	force unnormalized	Force address cords to be unorm: 0 = address coordinates are normalized, in [0,1); 1 = address coordinates are unnormalized:[0,dim).
18:16	3	aniso threshold	threshold under which floor(aniso ratio) determines number of samples and step size
19	1	mc coord trunc	enables bilinear blend fraction truncation to 1 bit for motion compensation
20	1	force degamma	force format to srgb if data_format allows
26:21	6	aniso bias	6 bits, in u1.5 format.
27	1	trunc coord	selects texel coordinate rounding or truncation.
28	1	disable cube wrap	disables seamless DX10 cubemaps, allows cubemaps to clamp according to clamp_x and clamp_y fields
30:29	2	filter_mode	0 = Blend (lerp); 1 = min, 2 = max.
31	1	skip degamma	disabled degamma (sRGB → Linear) conversion.
43:32	12	min lod	minimum LOD ins resource view space (0.0 = T#.base_level) u4.8.
55:44	12	max lod	maximum LOD ins resource view space
59:56	4	perf_mip	defines range of lod fractions that snap to nearest mip only when mip_filter=Linear
63:60	4	perf z	defines range of z fractions that snap to nearest z layer z_filter=Linear
75:64	12	lod bias	s6.8. This is bits[11:0] of the LOD bias.

Bits	Size	Name	Description
77:76	2	lod bias high	This is bits [13:12] of the LOD bias.
83:78	6	lod bias sec	bias added to computed LOD, scaled by T#.perf_modulation. s2.4.
85:84	2	xy mag filter	Magnification filter: 0=point, 1=bilinear, 2=aniso-point, 3=aniso-linear
87:86	2	xy min filter	Minification filter: 0=point, 1=bilinear, 2=aniso-point, 3=aniso-linear
89:88	2	z filter	Volume Filter: 0=none (use XY min/mag filter), 1=point, 2=linear
91:90	2	mip filter	Mip level filter: 0=none (disable mipmapping,use base-level), 1=point, 2=linear
93	1	Aniso_override	Disable Aniso filtering if base_level = last_level
94	1	blend_zero_prt	For PRT fetches, zero out texel if not resident
95	1	reserved	reserved. set to zero.
107:96	12	border color ptr	
127:126	2	border color type	Opaque-black, transparent-black, white, use border color ptr.

### 8.2.8. Data Formats

The table below details all the data formats that can be used by image and buffer resources.

Table 47. Buffer and Image Data Formats

#	Buffer and Image Formats	#	Buffer and Image Formats	#	Image Formats
0	INVALID	43	11_11_10_FLOAT	128	8_SRGB
1	8_UNORM	44	10_10_10_2_UNORM	129	8_8_SRGB
2	8_SNORM	45	10_10_10_2_SNORM	130	8_8_8_8_SRGB
3	8_USCALED	48	10_10_10_2_UINT	131	6E4_FLOAT
4	8_SSCALED	49	10_10_10_2_SINT	132	5_9_9_9_FLOAT
5	8_UINT	50	2_10_10_10_UNORM	133	5_6_5_UNORM
6	8_SINT	51	2_10_10_10_SNORM	134	1_5_5_5_UNORM
7	16_UNORM	52	2_10_10_10_USCALED	135	5_5_5_1_UNORM
8	16_SNORM	53	2_10_10_10_SSCALED	136	4_4_4_4_UNORM
9	16_USCALED	54	2_10_10_10_UINT	137	4_4_UNORM
10	16_SSCALED	55	2_10_10_10_SINT	138	1_UNORM
11	16_UINT	56	8_8_8_8_UNORM	139	1_REVERSED_UNORM
12	16_SINT	57	8_8_8_8_SNORM	140	32_FLOAT_CLAMP
13	16_FLOAT	58	8_8_8_8_USCALED	141	8_24_UNORM
14	8_8_UNORM	59	8_8_8_8_SSCALED	142	8_24_UINT

#	Buffer and Image Formats	#	Buffer and Image Formats	#	Image Formats
15	8_8_SNORM	60	8_8_8_8_UINT	143	24_8_UNORM
16	8_8_USCALED	61	8_8_8_8_SINT	144	24_8_UINT
17	8_8_SSCALED	62	32_32_UINT	145	X24_8_32_UINT
18	8_8_UINT	63	32_32_SINT	146	X24_8_32_FLOAT
19	8_8_SINT	64	32_32_FLOAT	147	GB_GR_UNORM
20	32_UINT	65	16_16_16_16_UNORM	148	GB_GR_SNORM
21	32_SINT	66	16_16_16_16_SNORM	149	GB_GR_UINT
22	32_FLOAT	67	16_16_16_16_USCALED	150	GB_GR_SRGB
23	16_16_UNORM	68	16_16_16_16_SSCALED	151	BG_RG_UNORM
24	16_16_SNORM	69	16_16_16_16_UINT	152	BG_RG_SNORM
25	16_16_USCALED	70	16_16_16_16_SINT	153	BG_RG_UINT
26	16_16_SSCALED	71	16_16_16_16_FLOAT	154	BG_RG_SRGB
27	16_16_UINT	72	32_32_32_UINT		
28	16_16_SINT	73	32_32_32_SINT		Compressed Formats
29	16_16_FLOAT	74	32_32_32_FLOAT	169	BC1_UNORM
36	10_11_11_FLOAT	75	32_32_32_32_UINT	170	BC1_SRGB
		76	32_32_32_32_SINT	171	BC2_UNORM
		77	32_32_32_32_FLOAT	172	BC2_SRGB
				173	BC3_UNORM
				174	BC3_SRGB
				175	BC4_UNORM
				176	BC4_SNORM
				177	BC5_UNORM
				178	BC5_SNORM
				179	BC6_UFLOAT
				180	BC6_SFLOAT
				181	BC7_UNORM
				182	BC7_SRGB

### 8.2.9. Vector Memory Instruction Data Dependencies

When a VM instruction is issued, it schedules the reads of address and write-data from VGPRs to be sent to the texture unit. Any ALU instruction which attempts to write this data before it has

been sent to the texture unit will be stalled.

The shader developer's responsibility to avoid data hazards associated with VMEM instructions include waiting for VMEM read instruction completion before reading data fetched from the TC (VMCNT and VSCNT).

This is explained in the section: [Data Dependency Resolution](#)

### 8.2.10. Ray Tracing

Ray Tracing support includes the following instructions:

- IMAGE\_BVH\_INTERSECT\_RAY
- IMAGE\_BVH64\_INTERSECT\_RAY

These instructions receive ray data from the VGPRs and fetch BVH (Bounding Volume Hierarchy) from memory.

- Box BVH nodes perform 4x Ray/Box intersection, sorts the 4 children based on intersection distance and returns the child pointers and hit status.
- Triangle nodes perform 1 Ray/Triangle intersection test and returns the intersection point and triangle ID.

The two instructions are identical, except that the "64" version supports a 64-bit address while the normal version supports only a 32bit address. Both instructions can use the "A16" instruction field to reduce some (but not all) of the address components to 16 bits (from 32). These addresses are: ray\_dir and ray\_inv\_dir.

#### Instruction definition and fields

```
image_bvh_intersect_ray vgpr_d[4], vgpr_a[11], sgpr_r[4]
image_bvh_intersect_ray vgpr_d[4], vgpr_a[8], sgpr_r[4] A16=1
image_bvh64_intersect_ray vgpr_d[4], vgpr_a[12], sgpr_r[4]
image_bvh64_intersect_ray vgpr_d[4], vgpr_a[9], sgpr_r[4] A16=1
```

Table 48. Ray Tracing VGPR Contents

VGPR_A	BVH A16=0	BVH A16=1	BVH64 A16=0	BVH64 A16=1
0	node_pointer (u32)	node_pointer (u32)	node_pointer [31:0] (u32)	node_pointer [31:0] (u32)
1	ray_extent (f32)	ray_extent (f32)	node_pointer [63:32] (u32)	node_pointer [63:32] (u32)
2	ray_origin.x (f32)	ray_origin.x (f32)	ray_extent (f32)	ray_extent (f32)
3	ray_origin.y (f32)	ray_origin.y (f32)	ray_origin.x (f32)	ray_origin.x (f32)
4	ray_origin.z (f32)	ray_origin.z (f32)	ray_origin.y (f32)	ray_origin.y (f32)



VGPR_A	BVH A16=0	BVH A16=1	BVH64 A16=0	BVH64 A16=1
5	ray_dir.x (f32)	[15:0] = ray_dir.x (f16) [31:16] = ray_dir.y (f16)	ray_origin.z (f32)	ray_origin.z (f32)
6	ray_dir.y (f32)	[15:0] = ray_dir.z (f16) [31:16] = ray_inv_dir.x(f16)	ray_dir.x (f32)	[15:0] = ray_dir.x (f16) [31:16] = ray_dir.y (f16)
7	ray_dir.z (f32)	[15:0] = ray_inv_dir.y (f16) [31:16] = ray_inv_dir.z (f16)	ray_dir.y (f32)	[15:0] = ray_dir.z (f16) [31:16] = ray_inv_dir.x(f16)
8	ray_inv_dir.x (f32)	unused	ray_dir.z (f32)	[15:0] = ray_inv_dir.y (f16) [31:16] = ray_inv_dir.z (f16)
9	ray_inv_dir.y (f32)	unused	ray_inv_dir.x (f32)	unused
10	ray_inv_dir.z (f32)	unused	ray_inv_dir.y (f32)	unused
11	unused	unused	ray_inv_dir.z (f32)	unused

**Vgpr\_d[4]** are the destination VGPRs of the results of intersection testing. The values returned here are different depending on the type of BVH node that was fetched. For box nodes the results contain the 4 pointers of the children boxes in intersection time sorted order. For triangle BVH nodes the results contain the intersection time and triangle ID of the triangle tested.

**Sgpr\_r[4]** is the texture descriptor for the operation. The instruction is encoded with `use_128bit_resource=1`.

### Restrictions on `image_bvh` instructions

- DMASK must be set to 0xf (instruction returns all four DWORDs)
- D16 must be set to 0 (16 bit return data is not supported)
- R128 must be set to 1 (256 bit T#s are not supported)
- UNRM must be set to 1 (only unnormalized coordinates are supported)
- DIM must be set to 0 (BVH textures are 1D)
- LWE must be set to 0 (LOD warn is not supported)
- TFE must be set to 0 (no support for writing out the extra DWORD for the PRT hit status)
- SSAMP must be set to 0 (just a placeholder, since samplers are not used by the instruction)

The return order settings of the BVH ops are ignored instead they use the in-order read return queue.

### Texture Resource Definition

The T# used with these instructions is different from other image instructions.

*Table 49. Ray Tracing Resource Contents*

Field	Bits	Size	Data
Base Address	39:0	40	Base address of the BVH texture 256 byte aligned
Reserved	54:40	15	Set to zero
Box growing amount	62:55	8	Number of ULPs to be added during ray-box test, encoded as unsigned integer
Box sorting enable	63	1	Whether the ray-box test result need to be sorted
Size	105:64	42	Number of nodes minus 1 in the BVH texture used to enforce bounds checking
Reserved	119:106	14	Set to zero
Triangle_return_mode	120	1	0: Return data for triangle tests are {0: t_num, 1: t_denom, 2: triangle_id, 3: hit_status} 1: Return data for triangle tests are {0: t_num, 1: t_denom, 2: I_num, 3: J_num}
Reserved	122:121	2	Set to zero
big_page	123	1	Describes resource page usage 0 : No page size override. 1 : Indicates when a whole resource is only using pages that are >= 64KB in size.
Type	127:124	4	Set to 0x8

### Barycentrics

The ray-tracing hardware is designed to support computation of barycentric coordinates directly in hardware. This uses the “triangle\_return\_mode” in the table in the previous section (T# descriptor).

Table 50. Ray Tracing Return Mode

DWORD	Return Mode = 0		Return Mode = 1	
	Field Name	Type	Field Name	Type
0	t_num	float32	t_num	float32
1	t_denom	float32	t_denom	float32
2	triangle_id	uint32	I_num	float32
3	hit_status	uint32 (boolean value)	J_num	float32

# Chapter 9. Flat Memory Instructions

Flat Memory instructions read, or write, one piece of data into, or out of, VGPRs; they do this separately for each work-item in a wavefront. Unlike buffer or image instructions, Flat instructions do not use a resource constant to define the base address of a surface. Instead, Flat instructions use a single flat address from the VGPR; this addresses memory as a single flat memory space. This memory space includes video memory, system memory, LDS memory, and scratch (private) memory. It does not include GDS memory. Parts of the flat memory space may not map to any real memory, and accessing these regions generates a memory-violation error. The determination of the memory space to which an address maps is controlled by a set of "memory aperture" base and size registers.

## 9.1. Flat Memory Instruction

Flat memory instructions let the kernel read or write data in memory, or perform atomic operations on data already in memory. These operations occur through the texture L2 cache. The instruction declares which VGPR holds the address (either 32- or 64-bit, depending on the memory configuration), the VGPR which sends and the VGPR which receives data. Flat instructions also use M0 as described in the table below:

Table 51. Flat, Global and Scratch Microcode Formats

Field	Bit Size	Description
OP	7	Opcode. Can be Flat, Scratch or Global instruction. See next table.
ADDR	8	VGPR which holds the address. For 64-bit addresses, ADDR has the LSBs, and ADDR+1 has the MSBs. As an offset a single VGPR has a 32 bit unsigned offset. For FLAT_*: specifies an address. For GLOBAL_* and SCRATCH_* when SADDR is NULL: specifies an address. For GLOBAL_* and SCRATCH_* when SADDR is not NULL: specifies an offset.
DATA	8	VGPR which holds the first Dword of data. Instructions can use 0-4 Dwords.
VDST	8	VGPR destination for data returned to the kernel, either from LOADs or Atomic with GLC=1 (return pre-op value).
SLC	1	System Level Coherent. Used in conjunction with DLC to determine L2 cache policies.
DLC	1	Device Level Coherent. Controls GL1 cache bypass.
GLC	1	Global Level Coherent. For Atomic, GLC: 1 means return pre-op value, 0 means do not return pre-op value.
SEG	2	Memory Segment: 0=FLAT, 1=SCRATCH, 2=GLOBAL, 3=reserved.
LDS	1	When set, data is moved from memory to LDS instead of to VGPRs. Available only for loads. For Global and Scratch only; must be zero for Flat.
OFFSET	12	Address offset. Scratch, Global: 12-bit signed byte offset. Flat: must be positive.

Field	Bit Size	Description
SADDR	7	Scalar SGPR that provides an offset address. To disable use, set this field to NULL or 0x7f (exec_hi). Meaning of this field is different for Scratch and Global: Flat: Unused. Scratch: Use an SGPR (instead of VGPR) for the address. Global: Use the SGPR to provide a base address; the VGPR provides a 32-bit offset per lane.
M0	16	Implied use of M0 for SCRATCH and GLOBAL only when LDS=1. Provides the LDS address-offset.

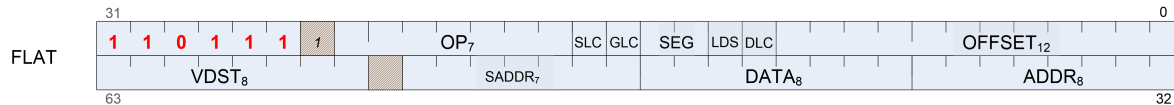

Table 52. Flat, Global and Scratch Opcodes

Flat Opcodes	Global Opcodes	Scratch Opcodes
FLAT	GLOBAL	SCRATCH
FLAT_LOAD_UBYTE	GLOBAL_LOAD_UBYTE	SCRATCH_LOAD_UBYTE
FLAT_LOAD_UBYTE_D16	GLOBAL_LOAD_UBYTE_D16	SCRATCH_LOAD_UBYTE_D16
FLAT_LOAD_UBYTE_D16_HI	GLOBAL_LOAD_UBYTE_D16_HI	SCRATCH_LOAD_UBYTE_D16_HI
FLAT_LOAD_SBYTE	GLOBAL_LOAD_SBYTE	SCRATCH_LOAD_SBYTE
FLAT_LOAD_SBYTE_D16	GLOBAL_LOAD_SBYTE_D16	SCRATCH_LOAD_SBYTE_D16
FLAT_LOAD_SBYTE_D16_HI	GLOBAL_LOAD_SBYTE_D16_HI	SCRATCH_LOAD_SBYTE_D16_HI
FLAT_LOAD_USHORT	GLOBAL_LOAD_USHORT	SCRATCH_LOAD_USHORT
FLAT_LOAD_SSHORT	GLOBAL_LOAD_SSHORT	SCRATCH_LOAD_SSHORT
FLAT_LOAD_SHORT_D16	GLOBAL_LOAD_SHORT_D16	SCRATCH_LOAD_SHORT_D16
FLAT_LOAD_SHORT_D16_HI	GLOBAL_LOAD_SHORT_D16_HI	SCRATCH_LOAD_SHORT_D16_HI
FLAT_LOAD_DWORD	GLOBAL_LOAD_DWORD	SCRATCH_LOAD_DWORD
FLAT_LOAD_DWORDX2	GLOBAL_LOAD_DWORDX2	SCRATCH_LOAD_DWORDX2
FLAT_LOAD_DWORDX3	GLOBAL_LOAD_DWORDX3	SCRATCH_LOAD_DWORDX3
FLAT_LOAD_DWORDX4	GLOBAL_LOAD_DWORDX4	SCRATCH_LOAD_DWORDX4
FLAT_STORE_BYTE	GLOBAL_STORE_BYTE	SCRATCH_STORE_BYTE
FLAT_STORE_BYTE_D16_HI	GLOBAL_STORE_BYTE_D16_HI	SCRATCH_STORE_BYTE_D16_HI
FLAT_STORE_SHORT	GLOBAL_STORE_SHORT	SCRATCH_STORE_SHORT
FLAT_STORE_SHORT_D16_HI	GLOBAL_STORE_SHORT_D16_HI	SCRATCH_STORE_SHORT_D16_HI
FLAT_STORE_DWORD	GLOBAL_STORE_DWORD	SCRATCH_STORE_DWORD
FLAT_STORE_DWORDX2	GLOBAL_STORE_DWORDX2	SCRATCH_STORE_DWORDX2
FLAT_STORE_DWORDX3	GLOBAL_STORE_DWORDX3	SCRATCH_STORE_DWORDX3
FLAT_STORE_DWORDX4	GLOBAL_STORE_DWORDX4	SCRATCH_STORE_DWORDX4

Flat Opcodes	Global Opcodes	Scratch Opcodes
FLAT_ATOMIC_SWAP	GLOBAL_ATOMIC_SWAP	none
FLAT_ATOMIC_CMPSWAP	GLOBAL_ATOMIC_CMPSWAP	none
FLAT_ATOMIC_ADD	GLOBAL_ATOMIC_ADD	none
FLAT_ATOMIC_SUB	GLOBAL_ATOMIC_SUB	none
FLAT_ATOMIC_SMIN	GLOBAL_ATOMIC_SMIN	none
FLAT_ATOMIC_UMIN	GLOBAL_ATOMIC_UMIN	none
FLAT_ATOMIC_SMAX	GLOBAL_ATOMIC_SMAX	none
FLAT_ATOMIC_UMAX	GLOBAL_ATOMIC_UMAX	none
FLAT_ATOMIC_AND	GLOBAL_ATOMIC_AND	none
FLAT_ATOMIC_OR	GLOBAL_ATOMIC_OR	none
FLAT_ATOMIC_XOR	GLOBAL_ATOMIC_XOR	none
FLAT_ATOMIC_INC	GLOBAL_ATOMIC_INC	none
FLAT_ATOMIC_DEC	GLOBAL_ATOMIC_DEC	none
FLAT_ATOMIC_FMIN	GLOBAL_ATOMIC_FMIN	none
FLAT_ATOMIC_FMAX	GLOBAL_ATOMIC_FMAX	none
FLAT_ATOMIC_FCMPSWAP	GLOBAL_ATOMIC_FCMPSWAP	none
none	GLOBAL_ATOMIC_CSUB	none
none	GLOBAL_LOAD_DWORD_ADDTID	none
none	GLOBAL_STORE_DWORD_ADDTID	none

The atomic instructions above are also available in "\_X2" versions (64-bit).

Note: GLOBAL\_ATOMIC\_CSUB requires that the user set GLC=1.

## 9.2. Instructions

The FLAT instruction set is nearly identical to the Buffer instruction set, but without the FORMAT reads and writes. Unlike Buffer instructions, FLAT instructions cannot return data directly to LDS, but only to VGPRs.

FLAT instructions do not use a resource constant (V#) or sampler (S#); however, they do require a additional register (FLAT\_SCRATCH) to hold scratch-space memory address information in case any threads' address resolves to scratch space. See the scratch section for details.

Internally, FLAT instruction are executed as both an LDS and a Buffer instruction; so, they increment both VM\_CNT/VS\_CNT and LGKM\_CNT and are not considered done until both have been decremented. There is no way beforehand to determine whether a FLAT instruction uses only LDS or texture memory space.

### 9.2.1. Ordering

Flat instructions can complete out of order with each other. If one flat instruction finds all of its data in Texture cache, and the next finds all of its data in LDS, the second instruction might complete first. If the two fetches return data to the same VGPR, the result are unknown.

### 9.2.2. Important Timing Consideration

Since the data for a FLAT load can come from either LDS or the texture cache, and because these units have different latencies, there is a potential race condition with respect to the VM\_CNT/VS\_CNT and LGKM\_CNT counters. Because of this, the only sensible S\_WAITCNT value to use after FLAT instructions is zero.

## 9.3. Addressing

FLAT instructions support both 64- and 32-bit addressing. The address size is set using a mode register (PTR32), and a local copy of the value is stored per wave.

The addresses for the aperture check differ in 32- and 64-bit mode; however, this is not covered here.

64-bit addresses are stored with the LSBs in the VGPR at ADDR, and the MSBs in the VGPR at ADDR+1.

For scratch space, the texture unit takes the address from the VGPR and does the following.

```
Address = VGPR[addr] + TID_in_wave * Size
         - private aperture base (in SH_MEM_BASES)
         + offset (from flat_scratch)
```

### 9.3.1. Legal Addressing Combinations

Not every combination of addressing modes is legal for each type of instruction. The legal combinations are:

- FLAT
  - a. VGPR (32 or 64 bit) supplies the complete address. SADDR must be NULL.
- Global
  - a. VGPR (32 or 64 bit) supplies the address. Indicated by: SADDR == NULL.
  - b. SGPR (64 bit) supplies an address, and a VGPR (32 bit) supplies an offset
- SCRATCH
  - a. VGPR (32 bit) supplies an offset. Indicated by SADDR==NULL.

- b. SGPR (32 bit) supplies an offset. Indicated by SADDR!=NULL.

Every mode above can also add the "instruction immediate offset" to the address.

## 9.4. Global

Global instructions are similar to Flat instructions, but the programmer must ensure that no threads access LDS space; thus, no LDS bandwidth is used by global instructions.

Global instructions offer two types of addressing:

- $\text{Memory\_addr} = \text{VGPR-address} + \text{instruction offset}$ .
- $\text{Memory\_addr} = \text{SGPR-address} + \text{VGPR-offset} + \text{instruction offset}$ .

The size of the address component is dependent on ADDRESS\_MODE: 32-bits or 64-bit pointers. The VGPR-offset is 32 bits.

These instructions also allow direct data movement to LDS from memory without going through VGPRs.

Since these instructions do not access LDS, only VM\_CNT/VS\_CNT is used, not LGKM\_CNT. If a global instruction does attempt to access LDS, the instruction returns MEM\_VIOL.

## 9.5. Scratch

Scratch instructions are similar to Flat, but the programmer must ensure that no threads access LDS space, and the memory space is swizzled. Thus, no LDS bandwidth is used by scratch instructions.

Scratch instructions also support multi-Dword access and mis-aligned access (although mis-aligned is slower).

Scratch instructions use the following addressing:

- $\text{Memory\_addr} = \text{flat\_scratch.addr} + \text{swizzle}(\text{V/SGPR\_offset} + \text{inst\_offset}, \text{threadID})$   
The offset can come from either an SGPR or a VGPR, and is a 32-bit unsigned byte.

The size of the address component is dependent on the ADDRESS\_MODE: 32-bits or 64-bit pointers. The VGPR-offset is 32 bits.

These instructions also allow direct data movement to LDS from memory without going through VGPRs.

Since these instructions do not access LDS, only VM\_CNT/VS\_CNT is used, not LGKM\_CNT. It

is not possible for a Scratch instruction to access LDS; thus, no error or aperture checking is done.

## 9.6. Memory Error Checking

Both the texture unit and LDS can report that an error occurred due to a bad address. This can occur for the following reasons:

- invalid address (outside any aperture)
- write to read-only surface
- misaligned data
- out-of-range address:
  - LDS access with an address outside the range: [ 0, MIN(M0, LDS\_SIZE)-1 ]
  - Scratch access with an address outside the range: [0, scratch-size -1 ]

The policy for threads with bad addresses is: writes outside this range do not write a value, and reads return zero.

Addressing errors from either LDS or texture are returned on their respective "instruction done" busses as MEM\_VIOL. This sets the wave's MEM\_VIOL TrapStatus bit and causes an exception (trap) if the corresponding EXCPEN bit is set.

## 9.7. Data

FLAT instructions can use zero to four consecutive Dwords of data in VGPRs and/or memory. The DATA field determines which VGPR(s) supply source data (if any), and the VDST VGPRs hold return data (if any). No data-format conversion is done.

"D16" instructions use only 16-bit of the VGPR instead of the full 32bits. "D16\_HI" instructions read or write only the high 16-bits, while "D16" use the low 16-bits. Scratch & Global D16 load instructions with LDS=1 will write the entire 32-bits of LDS.

## 9.8. Scratch Space (Private)

Scratch (thread-private memory) is an area of memory defined by the aperture registers. When an address falls in scratch space, additional address computation is automatically performed by the hardware. The kernel must provide additional information for this computation to occur in the form of the FLAT\_SCRATCH register.

The wavefront must supply the scratch size and offset (for space allocated to this wave) with every FLAT request. Prior to issuing any FLAT or Scratch instructions, the shader program must initialize the FLAT\_SCRATCH register with the base address of scratch space allocated this



wave.

FLAT\_SCRATCH is a 64-bit, byte address. The shader composes the value by adding together two separate values: the base address, which can be passed in via an initialized SGPR, or perhaps through a constant buffer, and the per-wave allocation offset (also initialized in an SGPR).

## Chapter 10. Data Share Operations

Local data share (LDS) is a very low-latency, RAM scratchpad for temporary data with at least one order of magnitude higher effective bandwidth than direct, uncached global memory. It permits sharing of data between work-items in a work-group, as well as holding parameters for pixel shader parameter interpolation. Unlike read-only caches, the LDS permits high-speed write-to-read re-use of the memory space (gather/read/load and scatter/write/store operations).

### 10.1. Overview

The figure below shows the conceptual framework of the LDS is integration into the memory of AMD GPUs using OpenCL.

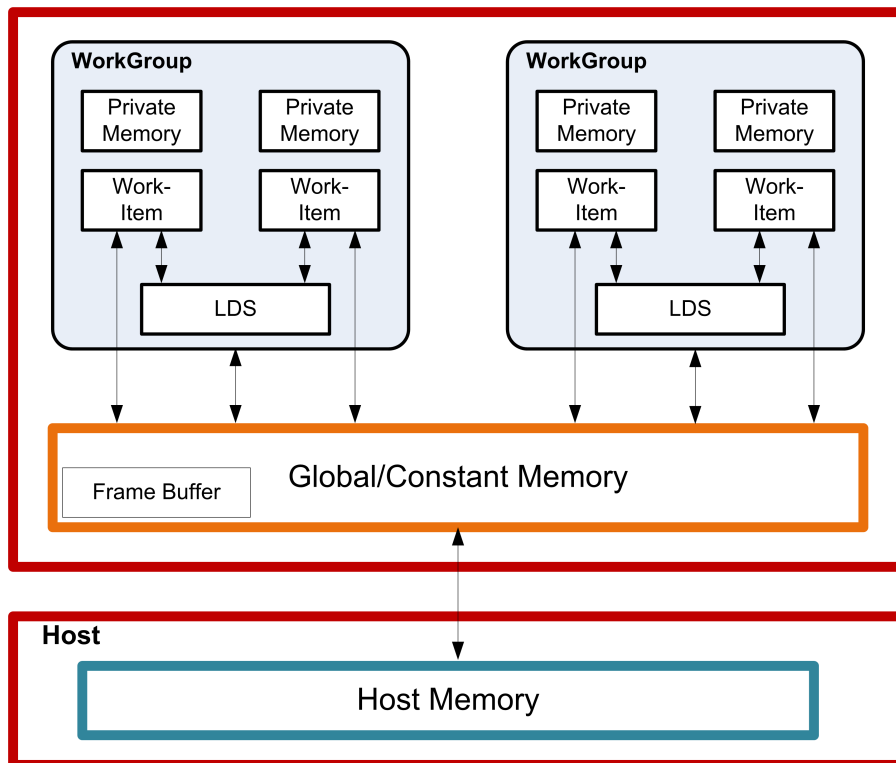

Figure 10. High-Level Memory Configuration

Physically located on-chip, directly adjacent to the ALUs, the LDS is approximately one order of magnitude faster than global memory (assuming no bank conflicts).

There are 128kB memory per workgroup processor split up into 64 banks of dword-wide RAMs. These 64 banks are further sub-divided into two sets of 32-banks each where 32 of the banks are affiliated with a pair of SIMD32's, and the other 32 banks are affiliated with the other pair of SIMD32's within the WGP. Each bank is a 512x32 two-port RAM (1R/1W per clock cycle). Dwords are placed in the banks serially, but all banks can execute a store or load simultaneously. One work-group can request up to 64kB memory.

The high bandwidth of the LDS memory is achieved not only through its proximity to the ALUs, but also through simultaneous access to its memory banks. Thus, it is possible to concurrently execute 32 write or read instructions, each nominally 32-bits; extended instructions, read2/write2, can be 64-bits each. If, however, more than one access attempt is made to the same bank at the same time, a bank conflict occurs. In this case, for indexed and atomic operations, the hardware is designed to prevent the attempted concurrent accesses to the same bank by turning them into serial accesses. This decreases the effective bandwidth of the LDS. For increased throughput (optimal efficiency), therefore, it is important to avoid bank conflicts. A knowledge of request scheduling and address mapping is key to achieving this.

## 10.2. Dataflow in Memory Hierarchy

The figure below is a conceptual diagram of the dataflow within the memory structure.

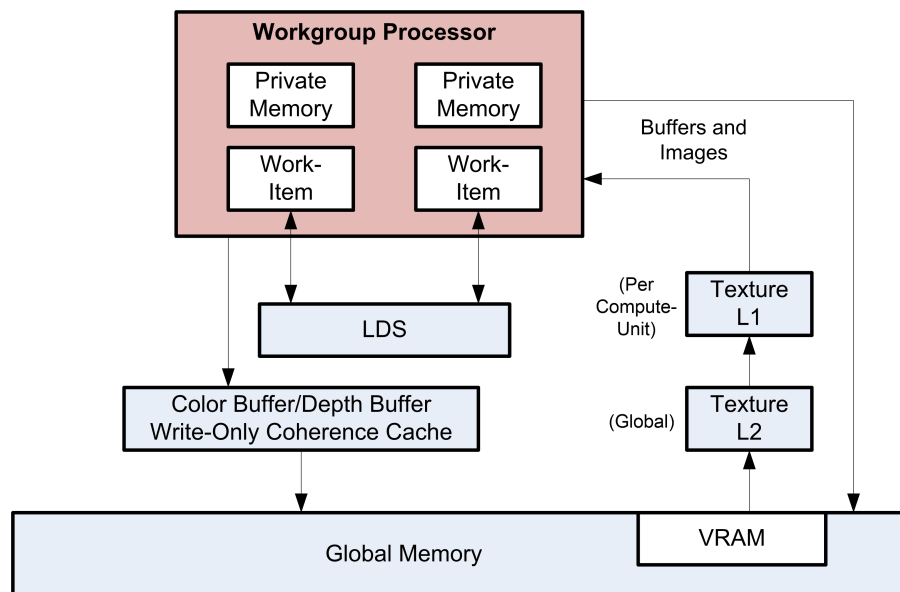

Data can be loaded into LDS either by transferring it from VGPRs to LDS using "DS" instructions, or by loading in from memory. When loading from memory, the data may be loaded into VGPRs first or for some types of loads it may be loaded directly into LDS from memory. To store data from LDS to global memory, data is read from LDS and placed into the workitem's VGPRs, then written out to global memory. To make effective use of the LDS, a kernel must perform many operations on what is transferred between global memory and LDS.

LDS atomics are performed in the LDS hardware. (Thus, although ALUs are not directly used for these operations, latency is incurred by the LDS executing this function.)

## 10.3. LDS Modes and Allocation: CU vs. WGP Mode

Workgroups of waves are dispatched in one of two modes: CU or WGP. This mode controls whether the waves of a workgroup are distributed across just two SIMD32's (CU mode), or

across all 4 SIMD32's (WGP mode) within a WGP.

In CU mode, waves are allocated to two SIMD32's which share a texture memory unit, and are allocated LDS space which is all local (on the same side) as the SIMDs. This mode can provide higher LDS memory bandwidth than WGP mode.

In WGP mode, the waves are distributed over all 4 SIMD32's and LDS space maybe allocated anywhere within the LDS memory. Waves may access data on the "near" or "far" side of LDS equally, but performance may be lower in some cases. This mode provides more ALU and texture memory bandwidth to a single workgroup (of at least 4 waves).

## 10.4. LDS Access

There are 3 forms of Local Data Share access:

- Direct Read – reads a single dword from LDS and broadcasts the data as input to a vector ALU op.
- Indexed Read/write and Atomic ops – read/write address comes from a VGPR and data to/from VGPR.
  - LDS-ops require up to 3 inputs: 2data+1addr and immediate return VGPR.
- Parameter Interpolation – similar to direct read but with specific addressing.
  - Reads up to 2 parameters (P0, P1-P0) or (P2-P0) from one attribute to be supplied to a muladd.
  - Also supplies individual parameter read for general interpolation (or select I,J=0.0)

The following subsections describe these methods.

### 10.4.1. LDS Direct Reads

Direct reads are only available in LDS, not in GDS.

LDS Direct reads occur in vector ALU (VALU) instructions and allow the LDS to supply a single DWORD value which is broadcast to all threads in the wavefront and is used as the SRC0 input to the ALU operations. A VALU instruction indicates that input is to be supplied by LDS by using the LDS\_DIRECT for the SRC0 field.

The LDS address and data-type of the data to be read from LDS comes from the M0 register:

```

LDS_addr = M0[15:0] (byte address and must be Dword aligned)
DataType = M0[18:16]
    0 unsigned byte
    1 unsigned short
    2 Dword
    3 unused
    4 signed byte
    5 signed short

```

## 10.4.2. LDS Parameter Reads

Parameter reads are only available in LDS, not in GDS.

Pixel shaders use LDS to read vertex parameter values; the pixel shader then interpolates them to find the per-pixel parameter values. LDS parameter reads occur when the following opcodes are used.

- V\_INTERP\_P1\_F32 D = P10 \* S + P0 Parameter interpolation, first step.
- V\_INTERP\_P2\_F32D = P20 \* S + DParameter interpolation, second step.
- V\_INTERP\_MOV\_F32D = {P10,P20,P0}[S]Parameter load.

The typical parameter interpolation operations involves reading three parameters: P0, P10, and P20, and using the two barycentric coordinates, I and J, to determine the final per-pixel value:

$$\text{Final value} = P0 + P10 * I + P20 * J$$

Parameter interpolation instructions indicate the parameter attribute number (0 to 32) and the component number (0=x, 1=y, 2=z and 3=w).

Table 53. Parameter Instruction Fields

Field	Size	Description
VDST	8	Destination VGPR. Also acts as source for v_interp_p2_f32.
OP	2	Opcode: 0: v_interp_p1_f32 VDST = P10 * VSRC + P0 1: v_interp_p2_f32 VDST = P20 * VSRC + VDST 2: v_interp_mov_f32 VDST = (P0, P10 or P20 selected by VSRC[1:0]) P0, P10 and P20 are parameter values read from LDS
ATTR	6	Attribute number: 0 to 32.
ATTRCHAN	2	0=X, 1=Y, 2=Z, 3=W
VSRC	8	Source VGPR supplies interpolation "I" or "J" value. For OP==v_interp_mov_f32: 0=P10, 1=P20, 2=P0.
( M0 )	32	Use of the M0 register is automatic. M0 must contain: { 1'b0, new_prim_mask[15:1], lds_param_offset[15:0] }

Parameter interpolation and parameter move instructions must initialize the M0 register before using it. The `lds_param_offset[15:0]` is an address offset from the beginning of LDS storage allocated to this wavefront to where parameters begin in LDS memory for this wavefront.

The **new\_prim\_mask** is a 15-bit mask with one bit per quad; a one in this mask indicates that this quad begins a new primitive, a zero indicates it uses the same primitive as the previous quad. The mask is 15 bits, not 16, since the first quad in a wavefront begins a new primitive and so it is not included in the mask.

### Parameter Interpolation on 16-bit data

The above parameter interpolation opcodes use the VINTRP microcode format, but for interpolation on 16-bit data, the VOP3 format is used. The opcodes supported are:

Opcode	Operation	Description
V_INTERP_P1LL_F16	$d.f32 = lds.f16 * vgpr.f32 + lds.f16$	attr_word selects LDS high or low 16bits. "LL" is for "two LDS arguments."
V_INTERP_P2_F16	$d.f16 = lds.f16 * vgpr.f32 + vgpr.f32$	Final computation. attr_word selects LDS high or low 16bits. Result is written to the 16 LSB's of the dest-vgpr.

In the VOP3 encoding, the following fields are overloaded:

- SRC1 : this field holds the VINTERP VSRC value (I or J)
- SRC0 : this is treated as a set of bit-fields: {attr\_word[1], attr\_chan[2], attr[6]}  
"attr\_word" is a bit to select the low or high half of the LDS word. 1=high, 0=low.

### 10.4.3. Data Share Indexed and Atomic Access

Both LDS and GDS can perform indexed and atomic data share operations. For brevity, "LDS" is used in the text below and, except where noted, also applies to GDS.

Indexed and atomic operations supply a unique address per work-item from the VGPRs to the LDS, and supply or return unique data per work-item back to VGPRs. Due to the internal banked structure of LDS, operations can complete in as little as one cycle (for wave32, or 2 cycles for wave64), or take as many 64 cycles, depending upon the number of bank conflicts (addresses that map to the same memory bank).

Indexed operations are simple LDS load and store operations that read data from, and return data to, VGPRs.

Atomic operations are arithmetic operations that combine data from VGPRs and data in LDS, and write the result back to LDS. Atomic operations have the option of returning the LDS "pre-op" value to VGPRs.

The table below lists and briefly describes the LDS instruction fields.

Table 54. LDS Instruction Fields

Field	Size	Description
OP	7	LDS opcode.
GDS	1	0 = LDS, 1 = GDS.
OFFSET0	8	Immediate offset, in bytes. Instructions with one address combine the offset fields into a single 16-bit unsigned offset: {offset1, offset0}. Instructions with two addresses (for example: READ2) use the offsets separately as two 8-bit unsigned offsets.
OFFSET1	8	
VDST	8	VGPR to which result is written: either from LDS-load or atomic return value.
ADDR	8	VGPR that supplies the byte address offset.
DATA0	8	VGPR that supplies first data source.
DATA1	8	VGPR that supplies second data source.

The M0 register is not used for most LDS-indexed operations: only the "ADD\_TID" instructions read M0 and for these it represents a byte address.

Table 55. LDS Indexed Load/Store

Load / Store	Description
DS_READ_{B32,B64,B96,B128,U8,I8,U16,I16}	Read one value per thread; sign extend to Dword, if signed.
DS_READ2_{B32,B64}	Read two values at unique addresses.
DS_READ2ST64_{B32,B64}	Read 2 values at unique addresses; offset *= 64.
DS_WRITE_{B32,B64,B96,B128,B8,B16}	Write one value.
DS_WRITE2_{B32,B64}	Write two values.
DS_WRITE2ST64_{B32,B64}	Write two values, offset *= 64.
DS_WRXCHG2_RTN_{B32,B64}	Exchange GPR with LDS-memory.
DS_WRXCHG2ST64_RTN_{B32,B64}	Exchange GPR with LDS-memory; offset *= 64.
DS_PERMUTE_B32	Forward permute. Does not write any LDS memory. LDS[dst] = src0 returnVal = LDS[thread_id] where thread_id is 0..63.
DS_BPERMUTE_B32	Backward permute. Does not actually write any LDS memory. LDS[thread_id] = src0 where thread_id is 0..63, and returnVal = LDS[dst].

### Single Address Instructions

$$\text{LDS\_Addr} = \text{LDS\_BASE} + \text{VGPR}[\text{ADDR}] + \{\text{InstrOffset1}, \text{InstrOffset0}\}$$

### Double Address Instructions

```
LDS_Addr0 = LDS_BASE + VGPR[ADDR] + InstrOffset0*ADJ +
LDS_Addr1 = LDS_BASE + VGPR[ADDR] + InstrOffset1*ADJ
Where ADJ = 4 for 8, 16 and 32-bit data types; and ADJ = 8 for 64-bit.
```

Note that LDS\_ADDR1 is used only for READ2\*, WRITE2\*, and WREXCHG2\*.

The address comes from VGPR, and both ADDR and InstrOffset are byte addresses.

At the time of wavefront creation, LDS\_BASE is assigned to the physical LDS region owned by this wavefront or work-group.

Specify only one address by setting both offsets to the same value. This causes only one read or write to occur and uses only the first DATA0.

### DS\_{READ,WRITE}\_ADD\_TID Addressing

```
LDS_Addr = LDS_BASE + {Inst_offset1, Inst_offset0} + TID(0..63)*4 + M0
Note: no part of the address comes from a VGPR. M0 must be dword-aligned.
```

The "ADD\_TID" (add thread-id) is a separate form where the base address for the instruction is common to all threads, but then each thread has a fixed offset added in based on its thread-ID within the wave. This allows a convenient way to quickly transfer data between VGPRs and LDS without having to use a VGPR to supply an address.

### LDS Atomic Ops

DS\_<atomicOp> OP, GDS=0, OFFSET0, OFFSET1, VDST, ADDR, Data0, Data1

Data size is encoded in atomicOp: byte, word, Dword, or double.

```
LDS_Addr0 = LDS_BASE + VGPR[ADDR] + {InstrOffset1,InstrOffset0}
```

ADDR is a Dword address. VGPRs 0,1 and dst are double-GPRs for doubles data.

VGPR data sources can only be VGPRs or constant values, not SGPRs.

## 10.4.4. LDS Lane-permute Ops

DS\_PERMUTE instructions allow data to be swizzled arbitrarily across 32 lanes. Two versions of the instruction are provided: a forward (scatter) and backward (gather).

Note that in wave64 mode the permute operates only across 32 lanes at a time of each half of a wave64. In other words, it executes as if were two independent wave32's. Each half-wave can



use indices in the range 0-31 to reference lanes in that same half-wave.

These instructions use the LDS hardware but do not use any memory storage, and may be used by waves which have not allocated any LDS space. The instructions supply a data value from VGPRs and an index value per lane.

- ds\_permute\_b32 : Dst[index[0..31]] = src[0..31] Where [0..31] is the lane number
- ds\_bpermute\_b32 : Dst[0..31] = src[index[0..31]]

The EXEC mask is honored for both reading the source and writing the destination. Index values out of range will wrap around (only index bits [6:2] are used, the other bits of the index are ignored). Reading from disabled lanes returns zero.

In the instruction word: VDST is the dest VGPR, ADDR is the index VGPR, and DATA0 is the source data VGPR. Note that index values are in bytes (so multiply by 4), and have the 'offset0' field added to them before use.

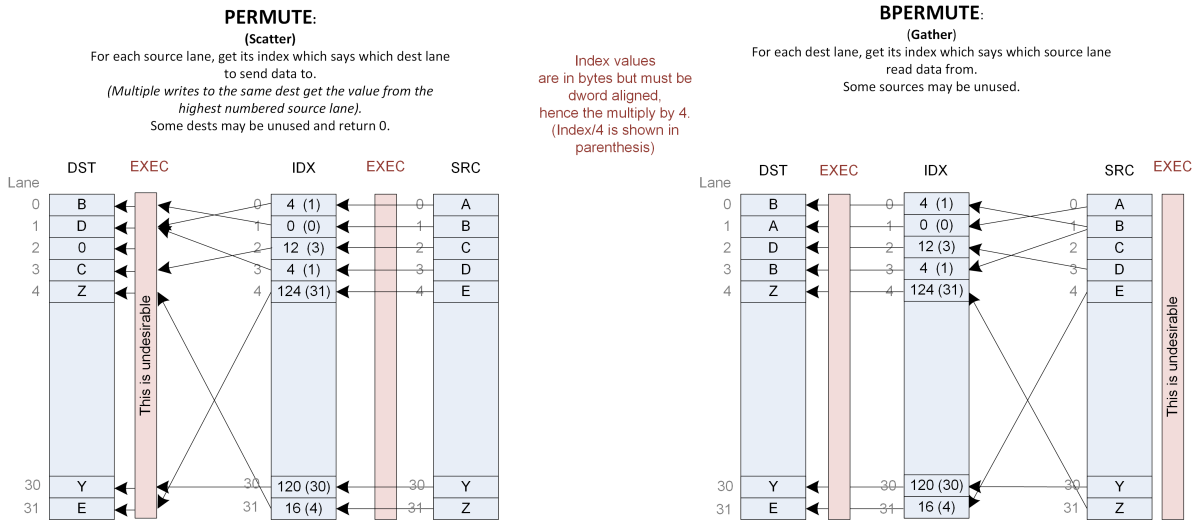

## 10.5. Global Data Share

Global data share is similar to LDS, but is a single memory accessible by all waves on the GPU. Global Data share uses the same instruction format as local data share (indexed operations only – no interpolation or direct reads). Instructions increment the LGKM\_cnt for all reads, writes and atomics, and decrement LGKM\_cnt when the instruction completes.

M0 is used for:

- [15:0] holds SIZE, in bytes
- [31:16] holds BASE address in bytes

# Chapter 11. Exporting Pixel and Vertex Data

The export instruction copies pixel or vertex shader data from VGPRs into a dedicated output buffer. The export instruction outputs the following types of data.

- Vertex Position
- Vertex Parameter
- Pixel color
- Pixel depth (Z)
- Primitive Data

## 11.1. Microcode Encoding

The export instruction uses the EXP microcode format.

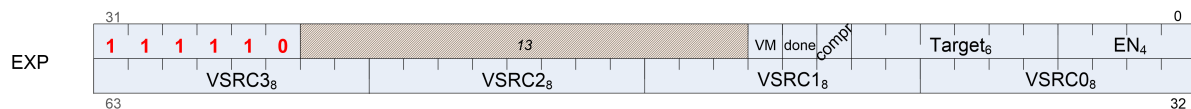

Table 56. EXP Encoding Field Descriptions

Field	Size	Description
VM	1	Valid Mask. When set to 1, this indicates that the EXEC mask represents the valid-mask for this wavefront. It can be sent multiple times per shader (the final value is used), but must be sent at least once per pixel shader.
DONE	1	This is the final pixel shader or vertex-position export of the program. Used only for pixel and position exports. Set to zero for parameters.
COMPR	1	Compressed data. When set, indicates that the data being exported is 16-bits per component rather than the usual 32-bit.
TARGET	6	Indicates type of data exported. <div style="border: 1px solid gray; padding: 5px; margin-top: 10px;"> <pre> 0..7 MRT 0..7 8 Z 9 Null (no data) 12-16 Position 0..4 20 Primitive data 32-63 Param 0..31                     </pre> </div>

Field	Size	Description
EN	4	<b>COMPR==1</b> : export half-Dword enable. Valid values are: 0x0,3,C,F. [0] enables VSRC0 : R,G from one VGPR [2] enables VSRC1 : B,A from one VGPR <b>COMPR==0</b> : [0-3] = enables for VSRC0..3. EN can be zero (used when exporting only valid mask to NULL target).
VSRC3	8	VGPR from which to read data. Pos & Param: vsrc0=X, 1=Y, 2=Z, 3=W MRT: vsrc0=R, 1=G, 2=B, 3=A
VSRC2	8	
VSRC1	8	
VSRC0	8	

## 11.2. Operations

### 11.2.1. Pixel Shader Exports

Export instructions copy color data to the MRTs. Data has up to four components (R, G, B, A). Optionally, export instructions also output depth (Z) data.

Every pixel shader must have at least one export instruction. The last export instruction executed must have the DONE bit set to one.

The EXEC mask is applied to all exports. Only pixels with the corresponding EXEC bit set to 1 export data to the output buffer. Results from multiple exports are accumulated in the output buffer.

At least one export must have the VM bit set to 1. This export, in addition to copying data to the color or depth output buffer, also informs the color buffer which pixels are valid and which have been discarded. The value of the EXEC mask communicates the pixel valid mask. If multiple exports are sent with VM set to 1, the mask from the final export is used. If the shader program wants to only update the valid mask but not send any new data, the program can do an export to the NULL target.

### 11.2.2. Vertex Shader Exports

The vertex shader uses export instructions to output vertex position data and vertex parameter data to the output buffer. This data is passed on to subsequent pixel shaders.

Every vertex shader must output at least one position vector (x, y, z; w is optional) to the POS0 target. The last position export must have the DONE bit set to 1. A vertex shader can export zero or more parameters. For optimized performance, it is recommended to output all position

data as early as possible in the vertex shader.

## 11.3. Primitive Shader Exports

The primitive shader may export Position and Primitive data. Before exporting, the shader must request that space be allocated in the output buffer using the `ALLOC_REQ` message.

## 11.4. Dependency Checking

Export instructions are executed by the hardware in two phases. First, the instruction is selected to be executed, and `EXPCNT` is incremented by 1. At this time, the hardware requests the use of internal busses needed to complete the instruction.

When access to the bus is granted, the `EXEC` mask is read and the VGPR data sent out. After the last of the VGPR data is sent, the `EXPCNT` counter is decremented by 1.

Use `S_WAITCNT` on `EXPCNT` to prevent the shader program from overwriting `EXEC` or the VGPRs holding the data to be exported before the export operation has completed.

Multiple export instructions can be outstanding at one time. Exports of the same type (for example: position) are completed in order, but exports of different types can be completed out of order.

If the `STATUS` register's `SKIP_EXPORT` bit is set to one, the hardware treats all `EXPORT` instructions as if they were `NOPs`.

# Chapter 12. Instructions

This chapter lists, and provides descriptions for, all instructions in the RDNA Generation environment. Instructions are grouped according to their format.

**Instruction suffixes have the following definitions:**

- B32 Bitfield (untyped data) 32-bit
- B64 Bitfield (untyped data) 64-bit
- F16 floating-point 16-bit
- F32 floating-point 32-bit (IEEE 754 single-precision float)
- F64 floating-point 64-bit (IEEE 754 double-precision float)
- I8 signed 8-bit integer
- I16 signed 16-bit integer
- I32 signed 32-bit integer
- I64 signed 64-bit integer
- U16 unsigned 16-bit integer
- U32 unsigned 32-bit integer
- U64 unsigned 64-bit integer

If an instruction has two suffixes (for example, `_I32_F32`), the first suffix indicates the destination type, the second the source type.

The following abbreviations are used in instruction definitions:

- D = destination
- U = unsigned integer
- S = source
- SCC = scalar condition code
- I = signed integer
- B = bitfield

Note: `.u` or `.i` specifies to interpret the argument as an unsigned or signed integer.

Note: Rounding and Denormal modes apply to all floating-point operations unless otherwise specified in the instruction description.

## 12.1. SOP2 Instructions



Instructions in this format may use a 32-bit literal constant which occurs immediately after the instruction.

Opcode	Name	Description
0	S_ADD_U32	Add two unsigned integers with carry-out.  $D.u32 = S0.u32 + S1.u32;$ $SCC = S0.u32 + S1.u32 \geq 0x100000000ULL ? 1 : 0.$
1	S_SUB_U32	Subtract the second unsigned integer from the first with carry-out.  $D.u = S0.u - S1.u;$ $SCC = (S1.u > S0.u ? 1 : 0).$ // unsigned overflow or carry-out for S_SUBB_U32.
2	S_ADD_I32	Add two signed integers with carry-out.  This opcode is not suitable for use with S_ADDC_U32 for implementing 64-bit operations.  $D.i = S0.i + S1.i;$ $SCC = (S0.u[31] == S1.u[31] \&\& S0.u[31] != D.u[31]).$ // signed overflow.
3	S_SUB_I32	Subtract the second signed integer from the first with carry-out.  This opcode is not suitable for use with S_SUBB_U32 for implementing 64-bit operations.  $D.i = S0.i - S1.i;$ $SCC = (S0.u[31] != S1.u[31] \&\& S0.u[31] != D.u[31]).$ // signed overflow.
4	S_ADDC_U32	Add two unsigned integers with carry-in and carry-out.  $D.u32 = S0.u32 + S1.u32 + SCC;$ $SCC = S0.u32 + S1.u32 + SCC \geq 0x100000000ULL ? 1 : 0.$
5	S_SUBB_U32	Subtract the second unsigned integer from the first with carry-in and carry-out.  $D.u = S0.u - S1.u - SCC;$ $SCC = (S1.u + SCC > S0.u ? 1 : 0).$ // unsigned overflow.
6	S_MIN_I32	Minimum of two signed integers.  $D.i = (S0.i < S1.i) ? S0.i : S1.i;$ $SCC = (S0.i < S1.i).$
7	S_MIN_U32	Minimum of two unsigned integers.  $D.u = (S0.u < S1.u) ? S0.u : S1.u;$ $SCC = (S0.u < S1.u).$
8	S_MAX_I32	Maximum of two signed integers.  $D.i = (S0.i > S1.i) ? S0.i : S1.i;$ $SCC = (S0.i > S1.i).$

Opcode	Name	Description
9	S_MAX_U32	Maximum of two unsigned integers.  $D.u = (S0.u > S1.u) ? S0.u : S1.u;$ $SCC = (S0.u > S1.u).$
10	S_CSELECT_B32	Conditional select based on scalar condition code.  $D.u = SCC ? S0.u : S1.u.$
11	S_CSELECT_B64	Conditional select base on scalar condition code.  $D.u64 = SCC ? S0.u64 : S1.u64.$
14	S_AND_B32	Bitwise AND.  $D = S0 \& S1;$ $SCC = (D \neq 0).$
15	S_AND_B64	Bitwise AND.  $D = S0 \& S1;$ $SCC = (D \neq 0).$
16	S_OR_B32	Bitwise OR.  $D = S0 \mid S1;$ $SCC = (D \neq 0).$
17	S_OR_B64	Bitwise OR.  $D = S0 \mid S1;$ $SCC = (D \neq 0).$
18	S_XOR_B32	Bitwise XOR.  $D = S0 \wedge S1;$ $SCC = (D \neq 0).$
19	S_XOR_B64	Bitwise XOR.  $D = S0 \wedge S1;$ $SCC = (D \neq 0).$
20	S_ANDN2_B32	Bitwise ANDN2.  $D = S0 \& \sim S1;$ $SCC = (D \neq 0).$
21	S_ANDN2_B64	Bitwise ANDN2.  $D = S0 \& \sim S1;$ $SCC = (D \neq 0).$
22	S_ORN2_B32	Bitwise ORN2.  $D = S0 \mid \sim S1;$ $SCC = (D \neq 0).$
23	S_ORN2_B64	Bitwise ORN2.  $D = S0 \mid \sim S1;$ $SCC = (D \neq 0).$

Opcode	Name	Description
24	S_NAND_B32	Bitwise NAND.  D = $\sim(S0 \& S1)$ ; SCC = (D != 0).
25	S_NAND_B64	Bitwise NAND.  D = $\sim(S0 \& S1)$ ; SCC = (D != 0).
26	S_NOR_B32	Bitwise NOR.  D = $\sim(S0   S1)$ ; SCC = (D != 0).
27	S_NOR_B64	Bitwise NOR.  D = $\sim(S0   S1)$ ; SCC = (D != 0).
28	S_XNOR_B32	Bitwise XNOR.  D = $\sim(S0 \wedge S1)$ ; SCC = (D != 0).
29	S_XNOR_B64	Bitwise XNOR.  D = $\sim(S0 \wedge S1)$ ; SCC = (D != 0).
30	S_LSHL_B32	Logical shift left.  D.u = $S0.u \ll S1.u[4:0]$ ; SCC = (D.u != 0).
31	S_LSHL_B64	Logical shift left.  D.u64 = $S0.u64 \ll S1.u[5:0]$ ; SCC = (D.u64 != 0).
32	S_LSHR_B32	Logical shift right.  D.u = $S0.u \gg S1.u[4:0]$ ; SCC = (D.u != 0).
33	S_LSHR_B64	Logical shift right.  D.u64 = $S0.u64 \gg S1.u[5:0]$ ; SCC = (D.u64 != 0).
34	S_ASHR_I32	Arithmetic shift right (preserve sign bit).  D.i = $\text{signext}(S0.i) \gg S1.u[4:0]$ ; SCC = (D.i != 0).
35	S_ASHR_I64	Arithmetic shift right (preserve sign bit).  D.i64 = $\text{signext}(S0.i64) \gg S1.u[5:0]$ ; SCC = (D.i64 != 0).
36	S_BFM_B32	Bitfield mask.  D.u = $((1 \ll S0.u[4:0]) - 1) \ll S1.u[4:0]$ .



Opcode	Name	Description
37	S_BFM_B64	Bitfield mask.  $D.u64 = ((1ULL \ll S0.u[5:0]) - 1) \ll S1.u[5:0].$
38	S_MUL_I32	Multiply two signed integers.  $D.i = S0.i * S1.i.$
39	S_BFE_U32	Bit field extract. S0 is Data, S1[4:0] is field offset, S1[22:16] is field width.  $D.u = (S0.u \gg S1.u[4:0]) \& ((1 \ll S1.u[22:16]) - 1);$ $SCC = (D.u \neq 0).$
40	S_BFE_I32	Bit field extract. S0 is Data, S1[4:0] is field offset, S1[22:16] is field width.  $D.i = \text{signext}((S0.i \gg S1.u[4:0]) \& ((1 \ll S1.u[22:16]) - 1));$ $SCC = (D.i \neq 0).$
41	S_BFE_U64	Bit field extract. S0 is Data, S1[5:0] is field offset, S1[22:16] is field width.  $D.u64 = (S0.u64 \gg S1.u[5:0]) \& ((1 \ll S1.u[22:16]) - 1);$ $SCC = (D.u64 \neq 0).$
42	S_BFE_I64	Bit field extract. S0 is Data, S1[5:0] is field offset, S1[22:16] is field width.  $D.i64 = \text{signext}((S0.i64 \gg S1.u[5:0]) \& ((1 \ll S1.u[22:16]) - 1));$ $SCC = (D.i64 \neq 0).$
44	S_ABSDIFF_I32	Compute the absolute value of difference between two values.  $D.i = S0.i - S1.i;$ $\text{if}(D.i < 0) \text{ then}$ $D.i = -D.i;$ $\text{endif};$ $SCC = (D.i \neq 0).$  Functional examples:  $S\_ABSDIFF\_I32(0x00000002, 0x00000005) \Rightarrow 0x00000003$ $S\_ABSDIFF\_I32(0xffffffff, 0x00000000) \Rightarrow 0x00000001$ $S\_ABSDIFF\_I32(0x80000000, 0x00000000) \Rightarrow 0x80000000$ // Note: result is negative! $S\_ABSDIFF\_I32(0x80000000, 0x00000001) \Rightarrow 0x7fffffff$ $S\_ABSDIFF\_I32(0x80000000, 0xffffffff) \Rightarrow 0x7fffffff$ $S\_ABSDIFF\_I32(0x80000000, 0xffffffffe) \Rightarrow 0x7fffffff$
46	S_LSHL1_ADD_U32	Logical shift left by 1 bit and then add.  $D.u = (S0.u \ll N) + S1.u; // N \text{ is the shift value in the opcode}$ $SCC = (((S0.u \ll N) + S1.u) \geq 0x10000000ULL ? 1 : 0). // \text{unsigned overflow.}$
47	S_LSHL2_ADD_U32	Logical shift left by 2 bits and then add.  $D.u = (S0.u \ll N) + S1.u; // N \text{ is the shift value in the opcode}$ $SCC = (((S0.u \ll N) + S1.u) \geq 0x10000000ULL ? 1 : 0). // \text{unsigned overflow.}$

Opcode	Name	Description
48	S_LSHL3_ADD_U32	Logical shift left by 3 bits and then add.  $D.u = (S0.u \ll N) + S1.u$ ; // N is the shift value in the opcode $SCC = (((S0.u \ll N) + S1.u) \geq 0x100000000ULL ? 1 : 0)$ . // unsigned overflow.
49	S_LSHL4_ADD_U32	Logical shift left by 4 bits and then add.  $D.u = (S0.u \ll N) + S1.u$ ; // N is the shift value in the opcode $SCC = (((S0.u \ll N) + S1.u) \geq 0x100000000ULL ? 1 : 0)$ . // unsigned overflow.
50	S_PACK_LL_B32_B16	Pack two short values into the destination.  $D.u[31:0] = \{ S1.u[15:0], S0.u[15:0] \}$ .
51	S_PACK_LH_B32_B16	Pack two short values into the destination.  $D.u[31:0] = \{ S1.u[31:16], S0.u[15:0] \}$ .
52	S_PACK_HH_B32_B16	Pack two short values into the destination.  $D.u[31:0] = \{ S1.u[31:16], S0.u[31:16] \}$ .
53	S_MUL_HI_U32	Multiple two unsigned integers and store the high 32 bits.  $D.u = (S0.u * S1.u) \gg 32$ .
54	S_MUL_HI_I32	Multiple two signed integers and store the high 32 bits.  $D.i = (S0.i * S1.i) \gg 32$ .

## 12.2. SOPK Instructions

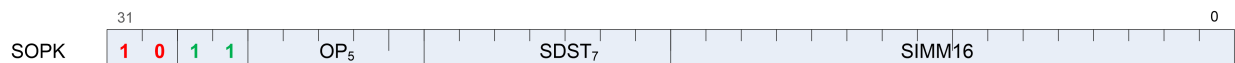

Instructions in this format may not use a 32-bit literal constant which occurs immediately after the instruction.

Opcode	Name	Description
0	S_MOVK_I32	Sign extension from a 16-bit constant.  $D.i32 = \text{signext}(SIMM16[15:0])$ .

Opcode	Name	Description
1	S_VERSION	<p>Do nothing. Argument is ignored by hardware. This opcode is not designed for inserting wait states as it is possible the next instruction will issue in the same cycle. Do not use this opcode to resolve wait state hazards, use S_NOP instead.</p> <p>This opcode is used to specify the microcode version for tools that interpret shader microcode; it may also be used to validate microcode is running with the correct compatibility settings in drivers and functional models that support multiple generations. We strongly encourage this opcode be included at the top of every shader block to simplify debug and catch configuration errors.</p> <p>This opcode must appear in the first 16 bytes of a block of shader code in order to be recognized by external tools and functional models. Avoid placing opcodes &gt; 32 bits or encodings that are not available in all versions of the microcode before the S_VERSION opcode. If this opcode is absent then tools are allowed to make a 'best guess' of the microcode version using cues from the environment; the guess may be incorrect and lead to an invalid decode. It is highly recommended that this be the FIRST opcode of a shader block except for trap handlers, where it should be the SECOND opcode (allowing the first opcode to be a 32-bit branch to accommodate context switch).</p> <p>SIMM16[7:0] specifies the microcode version. SIMM16[15:8] must be set to zero.</p>
2	S_CMOVK_I32	<p>Conditional move with sign extension.</p> <pre> if(SCC)     D.i32 = signext(SIMM16[15:0]); endif. </pre>
3	S_CMPK_EQ_I32	SCC = (S0.i32 == signext(SIMM16[15:0])).
4	S_CMPK_LG_I32	SCC = (S0.i32 != signext(SIMM16[15:0])).
5	S_CMPK_GT_I32	SCC = (S0.i32 > signext(SIMM16[15:0])).
6	S_CMPK_GE_I32	SCC = (S0.i32 >= signext(SIMM16[15:0])).
7	S_CMPK_LT_I32	SCC = (S0.i32 < signext(SIMM16[15:0])).
8	S_CMPK_LE_I32	SCC = (S0.i32 <= signext(SIMM16[15:0])).
9	S_CMPK_EQ_U32	SCC = (S0.u32 == SIMM16[15:0]).
10	S_CMPK_LG_U32	SCC = (S0.u32 != SIMM16[15:0]).
11	S_CMPK_GT_U32	SCC = (S0.u32 > SIMM16[15:0]).
12	S_CMPK_GE_U32	SCC = (S0.u32 >= SIMM16[15:0]).
13	S_CMPK_LT_U32	SCC = (S0.u32 < SIMM16[15:0]).
14	S_CMPK_LE_U32	SCC = (S0.u32 <= SIMM16[15:0]).

Opcode	Name	Description
15	S_ADDK_I32	<p>Add a 16-bit signed constant to the destination.</p> <pre> int32 tmp = D.i32; // save value so we can check sign bits for overflow later. D.i32 = D.i32 + signext(SIMM16[15:0]); SCC = (tmp[31] == SIMM16[15] &amp;&amp; tmp[31] != D.i32[31]). // signed overflow.</pre>
16	S_MULK_I32	<p>Multiply a 16-bit signed constant with the destination.</p> <pre> D.i32 = D.i32 * signext(SIMM16[15:0]).</pre>
18	S_GETREG_B32	<p>Read some or all of a hardware register into the LSBs of D.</p> <p>SIMM16 = {size[4:0], offset[4:0], hwRegId[5:0]}; offset is 0..31, size is 1..32.</p> <pre> uint32 offset = SIMM16[10:6]; uint32 size = SIMM16[15:11]; uint32 id = SIMM16[5:0]; D.u32 = hardware_reg[id][offset+size-1:offset].</pre>
19	S_SETREG_B32	<p>Write some or all of the LSBs of S0 into a hardware register.</p> <p>SIMM16 = {size[4:0], offset[4:0], hwRegId[5:0]}; offset is 0..31, size is 1..32.</p> <pre> hardware-reg = S0.u.</pre>
21	S_SETREG_IMM32_B32	<p>Write some or all of the LSBs of IMM32 into a hardware register; this instruction requires a 32-bit literal constant.</p> <p>SIMM16 = {size[4:0], offset[4:0], hwRegId[5:0]}; offset is 0..31, size is 1..32.</p> <pre> hardware-reg = LITERAL.</pre>
22	S_CALL_B64	<p>Implements a short call, where the return address (the next instruction after the S_CALL_B64) is saved to D. Long calls should consider S_SWAPPC_B64 instead.</p> <pre> D.u64 = PC + 4; PC = PC + signext(SIMM16 * 4) + 4.</pre>
23	S_WAITCNT_VSCNT	<p>Wait for the counts of outstanding vector store events -- vector memory stores and atomics that DO NOT return data -- to be at or below the specified level. This counter is not used in 'all-in-order' mode.</p> <p>Waits for the following condition to hold before continuing:</p> <pre> vscnt &lt;= S0.u[5:0] + S1.u[5:0]. // Comparison is 6 bits, no clamping is applied for add overflow</pre> <p>To wait on a literal constant only, write 'null' for the GPR argument.</p> <p>See also S_WAITCNT.</p>

Opcode	Name	Description
24	S_WAITCNT_VMCNT	<p>Wait for the counts of outstanding vector memory events -- everything except for memory stores and atomics-without-return -- to be at or below the specified level. When in 'all-in-order' mode, wait for all vector memory events.</p> <p>Waits for the following condition to hold before continuing:</p> <pre>vmcnt &lt;= S0.u[5:0] + S1.u[5:0]. // Comparison is 6 bits, no clamping is applied for add overflow</pre> <p>To wait on a literal constant only, write 'null' for the GPR argument or use S_WAITCNT.</p> <p>See also S_WAITCNT.</p>
25	S_WAITCNT_EXPCNT	<p>Waits for the following condition to hold before continuing:</p> <pre>expcnt &lt;= S0.u[2:0] + S1.u[2:0]. // Comparison is 3 bits, no clamping is applied for add overflow</pre> <p>To wait on a literal constant only, write 'null' for the GPR argument or use S_WAITCNT.</p> <p>See also S_WAITCNT.</p>
26	S_WAITCNT_LGKMCNT	<p>Waits for the following condition to hold before continuing:</p> <pre>lgkmcnt &lt;= S0.u[5:0] + S1.u[5:0]. // Comparison is 6 bits, no clamping is applied for add overflow</pre> <p>To wait on a literal constant only, write 'null' for the GPR argument or use S_WAITCNT.</p> <p>See also S_WAITCNT.</p>

Opcode	Name	Description
27	S_SUBVECTOR_LOOP_BEGIN	<p>Begin execution of a subvector block of code. See also S_SUBVECTOR_LOOP_END.</p> <pre> if(EXEC[63:0] == 0)     // no passes, skip entire loop     jump LABEL elif(EXEC_LO == 0)     // execute high pass only     D0 = EXEC_LO else     // execute low pass first, either running both passes or running low pass only     D0 = EXEC_HI     EXEC_HI = 0 endif.</pre> <p>Example:</p> <pre> s_subvector_loop_begin s0, SKIP_ALL LOOP_START:     // instructions     // ... LOOP_END:     s_subvector_loop_end s0, LOOP_START SKIP_ALL:</pre> <p>This opcode is intended to be used in conjunction with S_SUBVECTOR_LOOP_END but there is no dedicated subvector state and internally it is equivalent to an S_CBRANCH with extra math. This opcode has well-defined semantics in wave32 mode but the author of this document is not aware of any practical wave32 programming scenario where it would make sense to use this opcode.</p>
28	S_SUBVECTOR_LOOP_END	<p>End execution of a subvector block of code. See also S_SUBVECTOR_LOOP_START.</p> <pre> if(EXEC_HI != 0)     EXEC_LO = D0 elif(S0 == 0)     // done: executed low pass and skip high pass     nop else     // execute second pass of two-pass mode     EXEC_HI = D0     D0 = EXEC_LO     EXEC_LO = 0     jump LABEL endif.</pre> <p>This opcode is intended to be used in conjunction with S_SUBVECTOR_LOOP_BEGIN but there is no dedicated subvector state and internally it is equivalent to an S_CBRANCH with extra math. This opcode has well-defined semantics in wave32 mode but the author of this document is not aware of any practical wave32 programming scenario where it would make sense to use this opcode.</p>

## 12.3. SOP1 Instructions



Instructions in this format may use a 32-bit literal constant which occurs immediately after the instruction.

Opcode	Name	Description
3	S_MOV_B32	Move data to an SGPR.  D.u = S0.u.
4	S_MOV_B64	Move data to an SGPR.  D.u64 = S0.u64.
5	S_CMOV_B32	Conditionally move data to an SGPR when scalar condition code is true.  if(SCC) then D.u = S0.u; endif.
6	S_CMOV_B64	Conditionally move data to an SGPR when scalar condition code is true.  if(SCC) then D.u64 = S0.u64; endif.
7	S_NOT_B32	Bitwise negation.  D = ~S0; SCC = (D != 0).
8	S_NOT_B64	Bitwise negation.  D = ~S0; SCC = (D != 0).
9	S_WQM_B32	Computes whole quad mode for an active/valid mask. If any pixel in a quad is active, all pixels of the quad are marked active.  for i in 0 ... opcode_size_in_bits - 1 do D[i] = (S0[(i & ~3):(i   3)] != 0); endfor; SCC = (D != 0).
10	S_WQM_B64	Computes whole quad mode for an active/valid mask. If any pixel in a quad is active, all pixels of the quad are marked active.  for i in 0 ... opcode_size_in_bits - 1 do D[i] = (S0[(i & ~3):(i   3)] != 0); endfor; SCC = (D != 0).
11	S_BREV_B32	Reverse bits.  D.u[31:0] = S0.u[0:31].

Opcode	Name	Description
12	S_BREV_B64	Reverse bits.  D.u64[63:0] = S0.u64[0:63].
13	S_BCNT0_I32_B32	Count number of bits that are zero.  D = 0; for i in 0 ... opcode_size_in_bits - 1 do D += (S0[i] == 0 ? 1 : 0) endfor; SCC = (D != 0).  Functional examples:  S_BCNT0_I32_B32(0x00000000) => 32 S_BCNT0_I32_B32(0xcccccccc) => 16 S_BCNT0_I32_B32(0xffffffff) => 0
14	S_BCNT0_I32_B64	Count number of bits that are zero.  D = 0; for i in 0 ... opcode_size_in_bits - 1 do D += (S0[i] == 0 ? 1 : 0) endfor; SCC = (D != 0).  Functional examples:  S_BCNT0_I32_B32(0x00000000) => 32 S_BCNT0_I32_B32(0xcccccccc) => 16 S_BCNT0_I32_B32(0xffffffff) => 0
15	S_BCNT1_I32_B32	Count number of bits that are one.  D = 0; for i in 0 ... opcode_size_in_bits - 1 do D += (S0[i] == 1 ? 1 : 0) endfor; SCC = (D != 0).  Functional examples:  S_BCNT1_I32_B32(0x00000000) => 0 S_BCNT1_I32_B32(0xcccccccc) => 16 S_BCNT1_I32_B32(0xffffffff) => 32
16	S_BCNT1_I32_B64	Count number of bits that are one.  D = 0; for i in 0 ... opcode_size_in_bits - 1 do D += (S0[i] == 1 ? 1 : 0) endfor; SCC = (D != 0).  Functional examples:  S_BCNT1_I32_B32(0x00000000) => 0 S_BCNT1_I32_B32(0xcccccccc) => 16 S_BCNT1_I32_B32(0xffffffff) => 32



Opcode	Name	Description
17	S_FF0_I32_B32	<p>Returns the bit position of the first zero from the LSB (least significant bit), or -1 if there are no zeros.</p> <pre> D.i = -1; // Set if no zeros are found for i in 0 ... opcode_size_in_bits - 1 do // Search from LSB   if S0[i] == 0 then     D.i = i;     break for;   endif; endfor. </pre> <p>Functional examples:</p> <pre> S_FF0_I32_B32(0xaaaaaaaa) =&gt; 0 S_FF0_I32_B32(0x55555555) =&gt; 1 S_FF0_I32_B32(0x00000000) =&gt; 0 S_FF0_I32_B32(0xffffffff) =&gt; 0xffffffff S_FF0_I32_B32(0xfffeffff) =&gt; 16 </pre>
18	S_FF0_I32_B64	<p>Returns the bit position of the first zero from the LSB (least significant bit), or -1 if there are no zeros.</p> <pre> D.i = -1; // Set if no zeros are found for i in 0 ... opcode_size_in_bits - 1 do // Search from LSB   if S0[i] == 0 then     D.i = i;     break for;   endif; endfor. </pre> <p>Functional examples:</p> <pre> S_FF0_I32_B32(0xaaaaaaaa) =&gt; 0 S_FF0_I32_B32(0x55555555) =&gt; 1 S_FF0_I32_B32(0x00000000) =&gt; 0 S_FF0_I32_B32(0xffffffff) =&gt; 0xffffffff S_FF0_I32_B32(0xfffeffff) =&gt; 16 </pre>
19	S_FF1_I32_B32	<p>Returns the bit position of the first one from the LSB (least significant bit), or -1 if there are no ones.</p> <pre> D.i = -1; // Set if no ones are found for i in 0 ... opcode_size_in_bits - 1 do // Search from LSB   if S0[i] == 1 then     D.i = i;     break for;   endif; endfor. </pre> <p>Functional examples:</p> <pre> S_FF1_I32_B32(0xaaaaaaaa) =&gt; 1 S_FF1_I32_B32(0x55555555) =&gt; 0 S_FF1_I32_B32(0x00000000) =&gt; 0xffffffff S_FF1_I32_B32(0xffffffff) =&gt; 0 S_FF1_I32_B32(0x00010000) =&gt; 16 </pre>

Opcode	Name	Description
20	S_FF1_I32_B64	<p>Returns the bit position of the first one from the LSB (least significant bit), or -1 if there are no ones.</p> <pre> D.i = -1; // Set if no ones are found for i in 0 ... opcode_size_in_bits - 1 do // Search from LSB   if S0[i] == 1 then     D.i = i;     break for;   endif; endfor. </pre> <p>Functional examples:</p> <pre> S_FF1_I32_B32(0xaaaaaaaa) =&gt; 1 S_FF1_I32_B32(0x55555555) =&gt; 0 S_FF1_I32_B32(0x00000000) =&gt; 0xffffffff S_FF1_I32_B32(0xffffffff) =&gt; 0 S_FF1_I32_B32(0x00010000) =&gt; 16 </pre>
21	S_FLBIT_I32_B32	<p>Counts how many zeros before the first one starting from the MSB (most significant bit). Returns -1 if there are no ones.</p> <pre> D.i = -1; // Set if no ones are found for i in 0 ... opcode_size_in_bits - 1 do   // Note: search is from the MSB   if S0[opcode_size_in_bits - 1 - i] == 1 then     D.i = i;     break for;   endif; endfor. </pre> <p>Functional examples:</p> <pre> S_FLBIT_I32_B32(0x00000000) =&gt; 0xffffffff S_FLBIT_I32_B32(0x0000cccc) =&gt; 16 S_FLBIT_I32_B32(0xffff3333) =&gt; 0 S_FLBIT_I32_B32(0x7fffffff) =&gt; 1 S_FLBIT_I32_B32(0x80000000) =&gt; 0 S_FLBIT_I32_B32(0xffffffff) =&gt; 0 </pre>

Opcode	Name	Description
22	S_FLBIT_I32_B64	<p>Counts how many zeros before the first one starting from the MSB (most significant bit). Returns -1 if there are no ones.</p> <pre> D.i = -1; // Set if no ones are found for i in 0 ... opcode_size_in_bits - 1 do   // Note: search is from the MSB   if S0[opcode_size_in_bits - 1 - i] == 1 then     D.i = i;     break for;   endif; endfor.</pre> <p>Functional examples:</p> <pre> S_FLBIT_I32_B32(0x00000000) =&gt; 0xffffffff S_FLBIT_I32_B32(0x0000cccc) =&gt; 16 S_FLBIT_I32_B32(0xffff3333) =&gt; 0 S_FLBIT_I32_B32(0x7fffffff) =&gt; 1 S_FLBIT_I32_B32(0x80000000) =&gt; 0 S_FLBIT_I32_B32(0xffffffff) =&gt; 0</pre>
23	S_FLBIT_I32	<p>Counts how many bits in a row (from MSB to LSB) are the same as the sign bit. Returns -1 if all bits are the same.</p> <pre> D.i = -1; // Set if all bits are the same for i in 1 ... opcode_size_in_bits - 1 do   // Note: search is from the MSB   if S0[opcode_size_in_bits - 1 - i] != S0[opcode_size_in_bits - 1] then   D.i = i;   break for; endif; endfor.</pre> <p>Functional examples:</p> <pre> S_FLBIT_I32(0x00000000) =&gt; 0xffffffff S_FLBIT_I32(0x0000cccc) =&gt; 16 S_FLBIT_I32(0xffff3333) =&gt; 16 S_FLBIT_I32(0x7fffffff) =&gt; 1 S_FLBIT_I32(0x80000000) =&gt; 1 S_FLBIT_I32(0xffffffff) =&gt; 0xffffffff</pre>

Opcode	Name	Description
24	S_FLBIT_I32_I64	<p>Counts how many bits in a row (from MSB to LSB) are the same as the sign bit. Returns -1 if all bits are the same.</p> <pre> D.i = -1; // Set if all bits are the same for i in 1 ... opcode_size_in_bits - 1 do   // Note: search is from the MSB   if S0[opcode_size_in_bits - 1 - i] != S0[opcode_size_in_bits - 1] then   D.i = i;   break for; endif; endfor. </pre> <p>Functional examples:</p> <pre> S_FLBIT_I32(0x00000000) =&gt; 0xffffffff S_FLBIT_I32(0x0000cccc) =&gt; 16 S_FLBIT_I32(0xffff3333) =&gt; 16 S_FLBIT_I32(0x7fffffff) =&gt; 1 S_FLBIT_I32(0x80000000) =&gt; 1 S_FLBIT_I32(0xffffffff) =&gt; 0xffffffff </pre>
25	S_SEXT_I32_I8	<p>Sign extension of a signed byte.</p> <pre> D.i = signext(S0.i[7:0]). </pre>
26	S_SEXT_I32_I16	<p>Sign extension of a signed short.</p> <pre> D.i = signext(S0.i[15:0]). </pre>
27	S_BITSET0_B32	<p>Set a specific bit to zero.</p> <pre> D.u[S0.u[4:0]] = 0. </pre>
28	S_BITSET0_B64	<p>Set a specific bit to zero.</p> <pre> D.u64[S0.u[5:0]] = 0. </pre>
29	S_BITSET1_B32	<p>Set a specific bit to one.</p> <pre> D.u[S0.u[4:0]] = 1. </pre>
30	S_BITSET1_B64	<p>Set a specific bit to one.</p> <pre> D.u64[S0.u[5:0]] = 1. </pre>
31	S_GETPC_B64	<p>Save current program location. Destination receives the byte address of the next instruction.</p> <pre> D.u64 = PC + 4. </pre>
32	S_SETPC_B64	<p>Jump to a new location. S0.u64 is a byte address of the instruction to jump to.</p> <pre> PC = S0.u64. </pre>

Opcode	Name	Description
33	S_SWAPPC_B64	Save current program location and jump to a new location. S0.u64 is a byte address of the instruction to jump to. Destination receives the byte address of the instruction immediately following the SWAPPC instruction.  D.u64 = PC + 4; PC = S0.u64.
34	S_RFE_B64	Return from exception handler and continue. This instruction may only be used within a trap handler.  PRIV = 0; PC = S0.u64.
36	S_AND_SAVEEXEC_B64	Bitwise AND with EXEC mask. The original EXEC mask is saved to the destination SGPRs before the bitwise operation is performed.  D.u64 = EXEC; EXEC = S0.u64 & EXEC; SCC = (EXEC != 0).
37	S_OR_SAVEEXEC_B64	Bitwise OR with EXEC mask. The original EXEC mask is saved to the destination SGPRs before the bitwise operation is performed.  D.u64 = EXEC; EXEC = S0.u64   EXEC; SCC = (EXEC != 0).
38	S_XOR_SAVEEXEC_B64	Bitwise XOR with EXEC mask. The original EXEC mask is saved to the destination SGPRs before the bitwise operation is performed.  D.u64 = EXEC; EXEC = S0.u64 ^ EXEC; SCC = (EXEC != 0).
39	S_ANDN2_SAVEEXEC_C_B64	Bitwise ANDN2 with EXEC mask. The original EXEC mask is saved to the destination SGPRs before the bitwise operation is performed.  D.u64 = EXEC; EXEC = S0.u64 & ~EXEC; SCC = (EXEC != 0).
40	S_ORN2_SAVEEXEC_B64	Bitwise ORN2 with EXEC mask. The original EXEC mask is saved to the destination SGPRs before the bitwise operation is performed.  D.u64 = EXEC; EXEC = S0.u64   ~EXEC; SCC = (EXEC != 0).

Opcode	Name	Description
41	S_NAND_SAVEEXEC_B64	Bitwise NAND with EXEC mask. The original EXEC mask is saved to the destination SGPRs before the bitwise operation is performed.  <pre>D.u64 = EXEC; EXEC = ~(S0.u64 &amp; EXEC); SCC = (EXEC != 0).</pre>
42	S_NOR_SAVEEXEC_B64	Bitwise NOR with EXEC mask. The original EXEC mask is saved to the destination SGPRs before the bitwise operation is performed.  <pre>D.u64 = EXEC; EXEC = ~(S0.u64   EXEC); SCC = (EXEC != 0).</pre>
43	S_XNOR_SAVEEXEC_B64	Bitwise XNOR with EXEC mask. The original EXEC mask is saved to the destination SGPRs before the bitwise operation is performed.  <pre>D.u64 = EXEC; EXEC = ~(S0.u64 ^ EXEC); SCC = (EXEC != 0).</pre>
44	S_QUADMASK_B32	Reduce a pixel mask to a quad mask. To perform the inverse operation see S_BITREPLICATE_B64_B32.  <pre>D = 0; for i in 0 ... (opcode_size_in_bits / 4) - 1 do     D[i] = (S0[i * 4 + 3:i * 4] != 0); endfor; SCC = (D != 0).</pre>
45	S_QUADMASK_B64	Reduce a pixel mask to a quad mask. To perform the inverse operation see S_BITREPLICATE_B64_B32.  <pre>D = 0; for i in 0 ... (opcode_size_in_bits / 4) - 1 do     D[i] = (S0[i * 4 + 3:i * 4] != 0); endfor; SCC = (D != 0).</pre>
46	S_MOVRELS_B32	Move from a relative source address.  <pre>SGPR[D.addr].u32 = SGPR[S0.addr+M0[31:0]].u32</pre> <p>Example: The following instruction sequence will perform a move <code>s5 &lt;== s17</code>:</p> <pre>s_mov_b32 m0, 10 s_movrels_b32 s5, s7</pre>
47	S_MOVRELS_B64	Move from a relative source address. The index in M0.u must be even for this operation.  <pre>SGPR[D.addr].u64 = SGPR[S0.addr+M0[31:0]].u64</pre>

Opcode	Name	Description
48	S_MOVRELD_B32	<p>Move to a relative destination address.</p> $\text{SGPR}[\text{D.addr} + \text{M0}[31:0]].\text{u32} = \text{SGPR}[\text{S0.addr}].\text{u32}$ <p>Example: The following instruction sequence will perform a move <code>s15 &lt;== s7</code>:</p> <pre>s_mov_b32 m0, 10 s_movreld_b32 s5, s7</pre>
49	S_MOVRELD_B64	<p>Move to a relative destination address. The index in <code>M0.u</code> must be even for this operation.</p> $\text{SGPR}[\text{D.addr} + \text{M0}[31:0]].\text{u64} = \text{SGPR}[\text{S0.addr}].\text{u64}$
52	S_ABS_I32	<p>Integer absolute value.</p> $\text{D.i} = (\text{S.i} < 0 ? -\text{S.i} : \text{S.i});$ $\text{SCC} = (\text{D.i} \neq 0).$ <p>Functional examples:</p> <pre>S_ABS_I32(0x00000001) =&gt; 0x00000001 S_ABS_I32(0x7fffffff) =&gt; 0x7fffffff S_ABS_I32(0x80000000) =&gt; 0x80000000 // Note this is negative! S_ABS_I32(0x80000001) =&gt; 0x7fffffff S_ABS_I32(0x80000002) =&gt; 0x7ffffffe S_ABS_I32(0xffffffff) =&gt; 0x00000001</pre>
55	S_ANDN1_SAVEEXE_C_B64	<p>Bitwise ANDN1 with EXEC mask. The original EXEC mask is saved to the destination SGPRs before the bitwise operation is performed.</p> $\text{D.u64} = \text{EXEC};$ $\text{EXEC} = \sim\text{S0.u64} \& \text{EXEC};$ $\text{SCC} = (\text{EXEC} \neq 0).$
56	S_ORN1_SAVEEXEC_B64	<p>Bitwise ORN1 with EXEC mask. The original EXEC mask is saved to the destination SGPRs before the bitwise operation is performed.</p> $\text{D.u64} = \text{EXEC};$ $\text{EXEC} = \sim\text{S0.u64}   \text{EXEC};$ $\text{SCC} = (\text{EXEC} \neq 0).$
57	S_ANDN1_WREXEC_B64	<p>Bitwise ANDN1 with EXEC mask. Unlike the SAVEEXEC series of opcodes, the value written to destination SGPRs is the result of the bitwise-op result. EXEC and the destination SGPRs will have the same value at the end of this instruction. This instruction is intended to accelerate waterfalling.</p> $\text{EXEC} = \sim\text{S0.u64} \& \text{EXEC};$ $\text{D.u64} = \text{EXEC};$ $\text{SCC} = (\text{EXEC} \neq 0).$

Opcode	Name	Description
58	S_ANDN2_WREXEC_B64	<p>Bitwise ANDN2 with EXEC mask. Unlike the SAVEEXEC series of opcodes, the value written to destination SGPRs is the result of the bitwise-op result. EXEC and the destination SGPRs will have the same value at the end of this instruction. This instruction is intended to accelerate waterfalling.</p> <pre> EXEC = S0.u64 &amp; ~EXEC; D.u64 = EXEC; SCC = (EXEC != 0). </pre> <p>In particular, the following sequence of waterfall code is optimized by using a WREXEC instead of two separate scalar ops:</p> <pre> // V0 holds the index value per lane // save exec mask for restore at the end s_mov_b64 s2, exec // exec mask of remaining (unprocessed) threads s_mov_b64 s4, exec loop: // get the index value for the first active lane v_readfirstlane_b32 s0, v0 // find all other lanes with same index value v_cmpx_eq s0, v0 &lt;OP&gt; // do the operation using the current EXEC mask. S0 holds the index. // mask out thread that was just executed // s_andn2_b64 s4, s4, exec // s_mov_b64 exec, s4 s_andn2_wrexec_b64 s4, s4 // replaces above 2 ops // repeat until EXEC==0 s_cbranch_scc1 loop s_mov_b64 exec, s2 </pre>
59	S_BITREPLICATE_B64_B32	<p>Replicate the low 32 bits of S0 by 'doubling' each bit.</p> <pre> for i in 0 ... 31 do     D.u64[i * 2 + 0] = S0.u32[i]     D.u64[i * 2 + 1] = S0.u32[i] endfor. </pre> <p>This opcode can be used to convert a quad mask into a pixel mask; given quad mask in s0, the following sequence will produce a pixel mask in s2:</p> <pre> s_bitreplicate_b64 s2, s0 s_bitreplicate_b64 s2, s2 </pre> <p>To perform the inverse operation see S_QUADMASK_B64.</p>
60	S_AND_SAVEEXEC_B32	<p>Bitwise AND with EXEC mask. The original EXEC mask is saved to the destination SGPRs before the bitwise operation is performed.</p> <pre> D.u32 = EXEC_LO; EXEC_LO = S0.u32 &amp; EXEC_LO; SCC = (EXEC_LO != 0). </pre>



Opcode	Name	Description
61	S_OR_SAVEEXEC_B32	Bitwise OR with EXEC mask. The original EXEC mask is saved to the destination SGPRs before the bitwise operation is performed.  $D.u32 = EXEC\_L0;$ $EXEC\_L0 = S0.u32   EXEC\_L0;$ $SCC = (EXEC\_L0 != 0).$
62	S_XOR_SAVEEXEC_B32	Bitwise XOR with EXEC mask. The original EXEC mask is saved to the destination SGPRs before the bitwise operation is performed.  $D.u32 = EXEC\_L0;$ $EXEC\_L0 = S0.u32 ^ EXEC\_L0;$ $SCC = (EXEC\_L0 != 0).$
63	S_ANDN2_SAVEEXEC_B32	Bitwise ANDN2 with EXEC mask. The original EXEC mask is saved to the destination SGPRs before the bitwise operation is performed.  $D.u32 = EXEC\_L0;$ $EXEC\_L0 = S0.u32 \& \sim EXEC\_L0;$ $SCC = (EXEC\_L0 != 0).$
64	S_ORN2_SAVEEXEC_B32	Bitwise ORN2 with EXEC mask. The original EXEC mask is saved to the destination SGPRs before the bitwise operation is performed.  $D.u32 = EXEC\_L0;$ $EXEC\_L0 = S0.u32   \sim EXEC\_L0;$ $SCC = (EXEC\_L0 != 0).$
65	S_NAND_SAVEEXEC_B32	Bitwise NAND with EXEC mask. The original EXEC mask is saved to the destination SGPRs before the bitwise operation is performed.  $D.u32 = EXEC\_L0;$ $EXEC\_L0 = \sim(S0.u32 \& EXEC\_L0);$ $SCC = (EXEC\_L0 != 0).$
66	S_NOR_SAVEEXEC_B32	Bitwise NOR with EXEC mask. The original EXEC mask is saved to the destination SGPRs before the bitwise operation is performed.  $D.u32 = EXEC\_L0;$ $EXEC\_L0 = \sim(S0.u32   EXEC\_L0);$ $SCC = (EXEC\_L0 != 0).$
67	S_XNOR_SAVEEXEC_B32	Bitwise XNOR with EXEC mask. The original EXEC mask is saved to the destination SGPRs before the bitwise operation is performed.  $D.u32 = EXEC\_L0;$ $EXEC\_L0 = \sim(S0.u32 ^ EXEC\_L0);$ $SCC = (EXEC\_L0 != 0).$

Opcode	Name	Description
68	S_ANDN1_SAVEEXE C_B32	Bitwise ANDN1 with EXEC mask. The original EXEC mask is saved to the destination SGPRs before the bitwise operation is performed.  $D.u32 = EXEC\_L0;$ $EXEC\_L0 = \sim S0.u32 \& EXEC\_L0;$ $SCC = (EXEC\_L0 \neq 0).$
69	S_ORN1_SAVEEXEC _B32	Bitwise ORN1 with EXEC mask. The original EXEC mask is saved to the destination SGPRs before the bitwise operation is performed.  $D.u32 = EXEC\_L0;$ $EXEC\_L0 = \sim S0.u32   EXEC\_L0;$ $SCC = (EXEC\_L0 \neq 0).$
70	S_ANDN1_WREXEC_ B32	Bitwise ANDN1 with EXEC mask. Unlike the SAVEEXEC series of opcodes, the value written to destination SGPRs is the result of the bitwise-op result. EXEC and the destination SGPRs will have the same value at the end of this instruction. This instruction is intended to accelerate waterfalling.  $EXEC\_L0 = \sim S0.u32 \& EXEC\_L0;$ $D.u32 = EXEC\_L0;$ $SCC = (EXEC\_L0 \neq 0).$
71	S_ANDN2_WREXEC_ B32	Bitwise ANDN2 with EXEC mask. Unlike the SAVEEXEC series of opcodes, the value written to destination SGPRs is the result of the bitwise-op result. EXEC and the destination SGPRs will have the same value at the end of this instruction. This instruction is intended to accelerate waterfalling. See S_ANDN2_WREXEC_B64 for example code.  $EXEC\_L0 = S0.u32 \& \sim EXEC\_L0;$ $D.u32 = EXEC\_L0;$ $SCC = (EXEC\_L0 \neq 0).$
73	S_MOVRELS2_2_B32	Move from a relative source address to a relative destination address, with different offsets.  $SGPR[D.addr+M0[25:16]].u32 = SGPR[S0.addr+M0[9:0]].u32$  Example: The following instruction sequence will perform a move $s25 \ll= s17$ : $s\_mov\_b32\ m0, ((20 \ll 16)   10)$ $s\_movreld2\_b32\ s5, s7$

## 12.4. SOPC Instructions



Instructions in this format may use a 32-bit literal constant which occurs immediately after the instruction.

Opcode	Name	Description
0	S_CMP_EQ_I32	Compare two integers for equality. Note that S_CMP_EQ_I32 and S_CMP_EQ_U32 are identical opcodes, but both are provided for symmetry.  SCC = (S0 == S1).
1	S_CMP_LG_I32	Compare two integers for inequality. Note that S_CMP_LG_I32 and S_CMP_LG_U32 are identical opcodes, but both are provided for symmetry.  SCC = (S0 != S1).
2	S_CMP_GT_I32	SCC = (S0.i > S1.i).
3	S_CMP_GE_I32	SCC = (S0.i >= S1.i).
4	S_CMP_LT_I32	SCC = (S0.i < S1.i).
5	S_CMP_LE_I32	SCC = (S0.i <= S1.i).
6	S_CMP_EQ_U32	Compare two integers for equality. Note that S_CMP_EQ_I32 and S_CMP_EQ_U32 are identical opcodes, but both are provided for symmetry.  SCC = (S0 == S1).
7	S_CMP_LG_U32	Compare two integers for inequality. Note that S_CMP_LG_I32 and S_CMP_LG_U32 are identical opcodes, but both are provided for symmetry.  SCC = (S0 != S1).
8	S_CMP_GT_U32	SCC = (S0.u > S1.u).
9	S_CMP_GE_U32	SCC = (S0.u >= S1.u).
10	S_CMP_LT_U32	SCC = (S0.u < S1.u).
11	S_CMP_LE_U32	SCC = (S0.u <= S1.u).
12	S_BITCMP0_B32	SCC = (S0.u[S1.u[4:0]] == 0).
13	S_BITCMP1_B32	SCC = (S0.u[S1.u[4:0]] == 1).
14	S_BITCMP0_B64	SCC = (S0.u64[S1.u[5:0]] == 0).
15	S_BITCMP1_B64	SCC = (S0.u64[S1.u[5:0]] == 1).
18	S_CMP_EQ_U64	SCC = (S0.i64 == S1.i64).
19	S_CMP_LG_U64	SCC = (S0.i64 != S1.i64).

## 12.5. SOPP Instructions

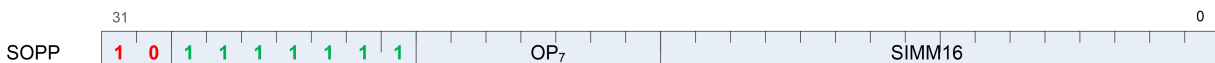

Opcode	Name	Description
0	S_NOP	<p>Do nothing. Repeat NOP 1..16 times based on SIMM16[3:0] -- 0x0 = 1 time, 0xf = 16 times.</p> <p>Examples:</p> <pre>s_nop 0      // Wait 1 cycle. s_nop 0xf    // Wait 16 cycles.</pre>
1	S_ENDPGM	<p>End of program; terminate wavefront. The hardware implicitly executes S_WAITCNT 0 and S_WAITCNT_VSCNT 0 before executing this instruction. See S_ENDPGM_SAVED for the context-switch version of this instruction and S_ENDPGM_ORDERED_PS_DONE for the POPS critical region version of this instruction.</p>
2	S_BRANCH	<p>Perform an unconditional short jump. For a long jump, use S_SETPC_B64.</p> <pre>PC = PC + signext(SIMM16 * 4) + 4. // short jump.</pre> <p>Examples:</p> <pre>s_branch label // Set SIMM16 = +4 = 0x0004 s_nop 0 // 4 bytes label: s_nop 0 // 4 bytes s_branch label // Set SIMM16 = -8 = 0xffff8</pre>
3	S_WAKEUP	<p>Allow a wave to 'ping' all the other waves in its threadgroup to force them to wake up early from an S_SLEEP instruction. The ping is ignored if the waves are not sleeping. This allows for efficient polling on a memory location. The waves which are polling can sit in a long S_SLEEP between memory reads, but the wave which writes the value can tell them all to wake up early now that the data is available. This is useful for fBarrier implementations (speedup). This method is also safe from races because if any wave misses the ping, everything still works fine (waves which missed it just complete their S_SLEEP).</p> <p>If the wave executing S_WAKEUP is in a threadgroup (in_tg set), then it will wake up all waves associated with the same threadgroup ID. Otherwise, S_WAKEUP is treated as an S_NOP.</p>
4	S_CBRANCH_SCC0	<p>Perform a conditional short jump when SCC is zero.</p> <pre>if(SCC == 0) then     PC = PC + signext(SIMM16 * 4) + 4; endif.</pre>
5	S_CBRANCH_SCC1	<p>Perform a conditional short jump when SCC is one.</p> <pre>if(SCC == 1) then     PC = PC + signext(SIMM16 * 4) + 4; endif.</pre>
6	S_CBRANCH_VCCZ	<p>Perform a conditional short jump when VCC is zero.</p> <pre>if(VCC == 0) then     PC = PC + signext(SIMM16 * 4) + 4; endif.</pre>

Opcode	Name	Description
7	S_CBRANCH_VCCNZ	<p>Perform a conditional short jump when VCC is nonzero.</p> <pre> if(VCC != 0) then     PC = PC + signext(SIMM16 * 4) + 4; endif.</pre>
8	S_CBRANCH_EXECZ	<p>Perform a conditional short jump when EXEC is zero.</p> <pre> if(EXEC == 0) then     PC = PC + signext(SIMM16 * 4) + 4; endif.</pre>
9	S_CBRANCH_EXECNZ	<p>Perform a conditional short jump when EXEC is nonzero.</p> <pre> if(EXEC != 0) then     PC = PC + signext(SIMM16 * 4) + 4; endif.</pre>
10	S_BARRIER	<p>Synchronize waves within a threadgroup. If not all waves of the threadgroup have been created yet, waits for entire group before proceeding. If some waves in the threadgroup have already terminated, this waits on only the surviving waves. Barriers are legal inside trap handlers.</p>
11	S_SETKILL	<p>Set KILL bit to value of SIMM16[0]. Used primarily for debugging kill wave host command behavior.</p>
12	S_WAITCNT	<p>Wait for the counts of outstanding lds, vector-memory and export/vmem-write-data to be at or below the specified levels.</p> <p>Waits for all of the following conditions to hold before continuing:</p> <pre> vmcnt &lt;= {SIMM16[15:14], SIMM16[3:0]} expcnt &lt;= SIMM16[6:4] lgkmcnt &lt;= SIMM16[13:8]</pre> <p>NOTE: VMCNT only counts vector memory loads, image sample instructions, and vector memory atomics that return data. Contrast with the VSCNT counter.</p> <p>See also S_WAITCNT_VSCNT.</p>
13	S_SETHALT	<p>S_SETHALT can set/clear the HALT or FATAL_HALT status bits. The particular status bit is chosen by halt type control as indicated in SIMM16[2]; 0 = HALT bit select; 1 = FATAL_HALT bit select.</p> <p>When halt type control is set to 0 = HALT bit select: Set HALT bit to value of SIMM16[0]; 1 = halt, 0 = clear HALT bit. The halt flag is ignored while PRIV == 1 (inside trap handlers) but the shader will halt after the handler returns if HALT is still set at that time.</p> <p>When halt type control is set to 1 = FATAL_HALT bit select: Set FATAL_HALT bit to value of SIMM16[0]; 1 = fatal_halt, 0 = clear FATAL_HALT bit. Setting the fatal_halt flag halts the shader in or outside of the trap handlers.</p>

Opcode	Name	Description
14	S_SLEEP	<p>Cause a wave to sleep for <math>(64*(SIMM16[6:0]-1) .. 64*SIMM16[6:0])</math> clocks. The exact amount of delay is approximate. Compare with S_NOP. When SIMM16[6:0] is zero then no sleep occurs.</p> <p>Examples:</p> <pre>s_sleep 0    // Wait for 0 clocks. s_sleep 1    // Wait for 1-64 clocks. s_sleep 2    // Wait for 65-128 clocks.</pre>
15	S_SETPRIO	User settable wave priority is set to SIMM16[1:0]. 0 = lowest, 3 = highest. The overall wave priority is {SPIPrio[1:0] + UserPrio[1:0], WaveAge[3:0]}.
16	S_SENDMSG	Send a message upstream to VGT or the interrupt handler. SIMM16[9:0] contains the message type.
17	S_SENDMSGHALT	Send a message and then HALT the wavefront; see S_SENDMSG for details.
18	S_TRAP	<p>Enter the trap handler. This instruction may be generated internally as well in response to a host trap (HT = 1) or an exception. TrapID 0 is reserved for hardware use and should not be used in a shader-generated trap.</p> <pre>TrapID = SIMM16[7:0]; Wait for all instructions to complete; {TTMP1, TTMP0} = {1'h0, PCRewind[5:0], HT[0], TrapID[7:0], PC[47:0]}; PC = TBA; // trap base address PRIV = 1.</pre>
19	S_ICACHE_INV	<p>Invalidate entire L0 instruction cache.</p> <p>The hardware invalidates the instruction buffer, so no S_NOP instructions are required after S_ICACHE_INV.</p>
20	S_INCPERFLEVEL	Increment performance counter specified in SIMM16[3:0] by 1.
21	S_DECPERFLEVEL	Decrement performance counter specified in SIMM16[3:0] by 1.
22	S_TTRACEDATA	Send M0 as user data to the thread trace stream.
23	S_CBRANCH_CDBGSYS	<p>Perform a conditional short jump when the system debug flag is set.</p> <pre>if(conditional_debug_system != 0) then     PC = PC + signext(SIMM16 * 4) + 4; endif.</pre>
24	S_CBRANCH_CDBGUSER	<p>Perform a conditional short jump when the user debug flag is set.</p> <pre>if(conditional_debug_user != 0) then     PC = PC + signext(SIMM16 * 4) + 4; endif.</pre>

Opcode	Name	Description
25	S_CBRANCH_CDBGSY S_OR_USER	<p>Perform a conditional short jump when either the system or the user debug flag are set.</p> <pre> if(conditional_debug_system    conditional_debug_user) then     PC = PC + signext(SIMM16 * 4) + 4; endif.</pre>
26	S_CBRANCH_CDBGSY S_AND_USER	<p>Perform a conditional short jump when both the system and the user debug flag are set.</p> <pre> if(conditional_debug_system &amp;&amp; conditional_debug_user) then     PC = PC + signext(SIMM16 * 4) + 4; endif.</pre>
27	S_ENDPGM_SAVED	<p>End of program; signal that a wave has been saved by the context-switch trap handler and terminate wavefront. The hardware implicitly executes S_WAITCNT 0 and S_WAITCNT_VSCNT 0 before executing this instruction. See S_ENDPGM for additional variants.</p>
30	S_ENDPGM_ORDERED _PS_DONE	<p>End of program; signal that a wave has exited its POPS critical section and terminate wavefront. The hardware implicitly executes S_WAITCNT 0 and S_WAITCNT_VSCNT 0 before executing this instruction. This instruction is an optimization that combines S_SENDMSG(MSG_ORDERED_PS_DONE) and S_ENDPGM; there may be cases where you still need to send the message separately, in which case the shader must end with a regular S_ENDPGM instruction. See S_ENDPGM for additional variants.</p>
31	S_CODE_END	<p>Generate an illegal instruction interrupt.</p> <p>This instruction should NEVER appear in typical shader code. It is used to pad the end of a shader program to make it easier for analysis programs to locate the end of a shader program buffer. Use of this opcode in an embedded shader block may cause analysis tools to fail.</p> <p>To unambiguously mark the end of a shader buffer, this instruction must be specified five times in a row (total of 20 bytes) and analysis tools must ensure the opcode occurs at least five times to be certain they are at the end of the buffer. This is because the bit pattern generated by this opcode could incidentally appear in a valid instruction's second dword, literal constant or as part of a multi-DWORD image instruction.</p> <p>In short: do not embed this opcode in the middle of a valid shader program. DO use this opcode 5 times at the end of a shader program to clearly mark the end of the program.</p> <p>Example:</p> <pre> ... s_endpgm      // last real instruction in shader buffer s_code_end    // 1 s_code_end    // 2 s_code_end    // 3 s_code_end    // 4 s_code_end    // done!</pre>

Opcode	Name	Description
32	S_INST_PREFETCH	<p>Change instruction prefetch mode.</p> <p>SIMM16[1:0] specifies the prefetch mode to switch to.                      Defined prefetch modes are:</p> <ul style="list-style-type: none"> <li>0: reserved</li> <li>1: SQ_PREFETCH_1_LINE -- prefetch 1 line</li> <li>2: SQ_PREFETCH_2_LINES -- prefetch 2 lines</li> <li>3: SQ_PREFETCH_3_LINES -- prefetch 3 lines</li> </ul> <p>SIMM16[15:2] must be set to zero.</p>
33	S_CLAUSE	<p>Mark the beginning of a clause. The next instruction determines the clause type, which may be one of the following types.</p> <ul style="list-style-type: none"> <li>Texture, Buffer, Global, Scratch (clause may not mix atomics, loads &amp; stores)</li> <li>Flat (loads, stores and atomics may not be combined in a clause)</li> <li>LDS</li> <li>SMEM</li> <li>VALU</li> </ul> <p>Halting and killing a wave will break the clause.</p> <p>The clause length is: (SIMM16[5:0] + 1), and clauses must be 2 instructions or longer and no more than 63 instructions.</p> <p>SIMM16[11:8] determines the number of instructions per clause break, in the range 0..15. If SIMM16[11:8] == 0 then there are no clause breaks.</p> <p>The following instruction types cannot appear in a clause:</p> <ul style="list-style-type: none"> <li>SALU</li> <li>Export</li> <li>Branch</li> <li>Message</li> <li>GDS</li> </ul>



Opcode	Name	Description
35	S_WAITCNT_DEPCTR	<p>Bit mask of which dependency counters to wait to be zero, intended for debug and bug-workarounds.</p> <p>Waits for all of the following conditions to hold before continuing:</p> <pre> va_vdst &lt;= SIMM16[15:12]    SIMM16[15:12] == 0xf va_sdst &lt;= SIMM16[11:9]    SIMM16[11:9] == 0x7 va_ssrc == 0    SIMM16[8] == 1 hold_cnt == 0    SIMM16[7] == 1 vm_vsrc &lt;= SIMM16[4:2]    SIMM16[4:2] == 0x7 va_vcc == 0    SIMM16[1] == 1 sa_sdst == 0    SIMM16[0] == 1                     </pre> <p>Some wait values are smaller than the counters: the max "wait" value means "don't wait on this counter". For example, VM_VSRC is 4 bits, but the wait field for VM_VSRC is only 3 bits. The value 7 means don't wait on VM_VSRC, 6 means wait for VM_VSRC &lt;= 6, etc. The wait value for VA_VCC is just 1 bit even though the counter is 3 bits: 0 = wait for va_vcc==0, 1 = don't wait on va_vcc.</p>
36	S_ROUND_MODE	Set floating point round mode using an immediate constant. Avoids wait state penalty that would be imposed by S_SETREG.
37	S_DENORM_MODE	Set floating point denormal mode using an immediate constant. Avoids wait state penalty that would be imposed by S_SETREG.
40	S_TTRACEDATA_IMM	Send SIMM16[7:0] as user data to the thread trace stream.

### 12.5.1. Send Message

The S\_SENDMSG instruction encodes the message type in M0, and can also send data from the SIMM16 field and in some cases from EXEC.

Message	SIMM16[3:0]	SIMM16[6:4]	Payload
none	0	-	illegal
GS	2	0=nop, 1=cut,	GS output. M0[4:0]=gs-waveID, SIMM[9:8] = stream-id
GS-done	3	2=emit, 3=emit-cut	
Save wave	4	-	used in context switching
Stall Wave Gen	5	-	stop new wave generation
Halt Waves	6	-	halt all running waves of this vmid
Ordered PS Done	7	-	POPS ordered section done
GS alloc req	9	-	Request GS space in parameter cache. M0[9:0] = number of vertices, M0[22:12] = number of primitives.

## 12.6. SMEM Instructions

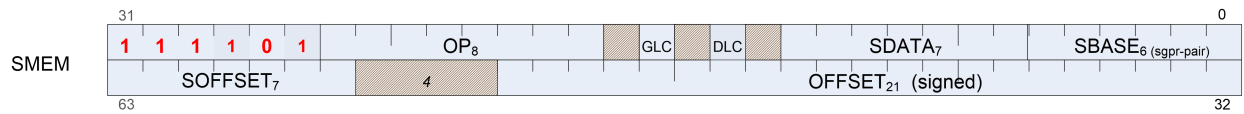

Opcode	Name	Description
0	S_LOAD_DWORD	Read 1 dword from scalar data cache.  If the offset is specified as an SGPR, the SGPR contains an UNSIGNED BYTE offset (the 2 LSBs are ignored).  If the offset is specified as an immediate 21-bit constant, the constant is a SIGNED BYTE offset.
1	S_LOAD_DWORDX2	Read 2 dwords from scalar data cache. See S_LOAD_DWORD for details on the offset input.
2	S_LOAD_DWORDX4	Read 4 dwords from scalar data cache. See S_LOAD_DWORD for details on the offset input.
3	S_LOAD_DWORDX8	Read 8 dwords from scalar data cache. See S_LOAD_DWORD for details on the offset input.
4	S_LOAD_DWORDX16	Read 16 dwords from scalar data cache. See S_LOAD_DWORD for details on the offset input.
8	S_BUFFER_LOAD_DWORD	Read 1 dword from scalar data cache. See S_LOAD_DWORD for details on the offset input.
9	S_BUFFER_LOAD_DWORDX2	Read 2 dwords from scalar data cache. See S_LOAD_DWORD for details on the offset input.
10	S_BUFFER_LOAD_DWORDX4	Read 4 dwords from scalar data cache. See S_LOAD_DWORD for details on the offset input.
11	S_BUFFER_LOAD_DWORDX8	Read 8 dwords from scalar data cache. See S_LOAD_DWORD for details on the offset input.
12	S_BUFFER_LOAD_DWORDX16	Read 16 dwords from scalar data cache. See S_LOAD_DWORD for details on the offset input.
31	S_GL1_INV	Invalidate the GL1 cache only.
32	S_DCACHE_INV	Invalidate the scalar data L0 cache.
36	S_MEMTIME	Return current 64-bit timestamp.
37	S_MEMREALTIME	Return current 64-bit RTC.
38	S_ATC_PROBE	Probe or prefetch an address into the SQC data cache.
39	S_ATC_PROBE_BUFFER	Probe or prefetch an address into the SQC data cache.

## 12.7. VOP2 Instructions



Instructions in this format may use a 32-bit literal constant, DPP or SDWA which occurs immediately after the instruction.

Opcode	Name	Description
1	V_CNDMASK_B32	<p>Conditional mask on each thread. In VOP3 the VCC source may be a scalar GPR specified in S2.u.</p> <p>Floating-point modifiers are valid for this instruction if S0.u and S1.u are 32-bit floating point values. This instruction is suitable for negating or taking the absolute value of a floating-point value.</p> $D.u32 = VCC ? S1.u32 : S0.u32.$
2	V_DOT2C_F32_F16	<p>Dot product of packed FP16 values, accumulate with destination.</p> $D.f32 = S0.f16[0] * S1.f16[0] + S0.f16[1] * S1.f16[1] + D.f32.$
3	V_ADD_F32	<p>Add two single-precision values. 0.5ULP precision, denormals are supported.</p> $D.f32 = S0.f32 + S1.f32.$
4	V_SUB_F32	<p>Subtract the second single-precision input from the first input.</p> $D.f32 = S0.f32 - S1.f32.$
5	V_SUBREV_F32	<p>Subtract the first single-precision input from the second input.</p> $D.f32 = S1.f32 - S0.f32.$
6	V_FMAC_LEGACY_F32_2	<p>Multiply two single-precision values and accumulate the result with the destination. Follows DX9 rules where 0.0 times anything produces 0.0 (this is not IEEE compliant).</p> $D.f32 = S0.f32 * S1.f32 + S2.f32. // \text{DX9 rules, } 0.0 * x = 0.0$
7	V_MUL_LEGACY_F32	<p>Multiply two single-precision values. Follows DX9 rules where 0.0 times anything produces 0.0 (this is not IEEE compliant).</p> $D.f32 = S0.f32 * S1.f32. // \text{DX9 rules, } 0.0 * x = 0.0$
8	V_MUL_F32	<p>Multiply two single-precision values. 0.5ULP precision, denormals are supported.</p> $D.f32 = S0.f32 * S1.f32.$
9	V_MUL_I32_I24	<p>Multiply two signed 24-bit integers and store the result as a signed 32-bit integer. This opcode is as efficient as basic single-precision opcodes since it utilizes the single-precision floating point multiplier. See also V_MUL_HI_I32_I24.</p> $D.i32 = S0.i24 * S1.i24.$

Opcode	Name	Description
10	V_MUL_HI_I32_I24	<p>Multiply two signed 24-bit integers and store the high 32 bits of the result as a signed 32-bit integer. See also V_MUL_I32_I24.</p> <pre>D.i32 = (S0.i24 * S1.i24)&gt;&gt;32;</pre>
11	V_MUL_U32_U24	<p>Multiply two unsigned 24-bit integers and store the result as an unsigned 32-bit integer. This opcode is as efficient as basic single-precision opcodes since it utilizes the single-precision floating point multiplier. See also V_MUL_HI_U32_U24.</p> <pre>D.u32 = S0.u24 * S1.u24.</pre>
12	V_MUL_HI_U32_U24	<p>Multiply two unsigned 24-bit integers and store the high 32 bits of the result as an unsigned 32-bit integer. See also V_MUL_U32_U24.</p> <pre>D.u32 = (S0.u24 * S1.u24)&gt;&gt;32.</pre>
13	V_DOT4C_I32_I8	<p>Dot product of packed byte values, accumulate with destination.</p> <pre>D.i32 =   S0.i8[0] * S1.i8[0] +   S0.i8[1] * S1.i8[1] +   S0.i8[2] * S1.i8[2] +   S0.i8[3] * S1.i8[3] + D.i32.</pre>
15	V_MIN_F32	<p>Compute the minimum of two single-precision floats.</p> <pre>D.f32 = min(S0.f32, S1.f32); if (IEEE_MODE &amp;&amp; S0.f == sNaN)   D.f = Quiet(S0.f); else if (IEEE_MODE &amp;&amp; S1.f == sNaN)   D.f = Quiet(S1.f); else if (S0.f == NaN)   D.f = S1.f; else if (S1.f == NaN)   D.f = S0.f; else if (S0.f == +0.0 &amp;&amp; S1.f == -0.0)   D.f = S1.f; else if (S0.f == -0.0 &amp;&amp; S1.f == +0.0)   D.f = S0.f; else   // Note: there's no IEEE special case here like there is for   V_MAX_F32.   D.f = (S0.f &lt; S1.f ? S0.f : S1.f); endif.</pre>

Opcode	Name	Description
16	V_MAX_F32	<p>Compute the maximum of two single-precision floats.</p> <pre> D.f32 = max(S0.f32, S1.f32); if (IEEE_MODE &amp;&amp; S0.f == sNaN)     D.f = Quiet(S0.f); else if (IEEE_MODE &amp;&amp; S1.f == sNaN)     D.f = Quiet(S1.f); else if (S0.f == NaN)     D.f = S1.f; else if (S1.f == NaN)     D.f = S0.f; else if (S0.f == +0.0 &amp;&amp; S1.f == -0.0)     D.f = S0.f; else if (S0.f == -0.0 &amp;&amp; S1.f == +0.0)     D.f = S1.f; else if (IEEE_MODE)     D.f = (S0.f &gt;= S1.f ? S0.f : S1.f); else     D.f = (S0.f &gt; S1.f ? S0.f : S1.f); endif. </pre>
17	V_MIN_I32	<p>Compute the minimum of two signed integers.</p> <pre> D.i32 = (S0.i32 &lt; S1.i32 ? S0.i32 : S1.i32). </pre>
18	V_MAX_I32	<p>Compute the maximum of two signed integers.</p> <pre> D.i32 = (S0.i32 &gt;= S1.i32 ? S0.i32 : S1.i32). </pre>
19	V_MIN_U32	<p>Compute the minimum of two unsigned integers.</p> <pre> D.u32 = (S0.u32 &lt; S1.u32 ? S0.u32 : S1.u32). </pre>
20	V_MAX_U32	<p>Compute the maximum of two unsigned integers.</p> <pre> D.u32 = (S0.u32 &gt;= S1.u32 ? S0.u32 : S1.u32). </pre>
22	V_LSHRREV_B32	<p>Logical shift right with shift count in the first operand.</p> <pre> D.u32 = S1.u32 &gt;&gt; S0[4:0]. </pre>
24	V_ASHRREV_I32	<p>Arithmetic shift right (preserve sign bit) with shift count in the first operand.</p> <pre> D.i32 = S1.i32 &gt;&gt; S0[4:0]. </pre>
26	V_LSHLREV_B32	<p>Logical shift left with shift count in the first operand.</p> <pre> D.u32 = S1.u32 &lt;&lt; S0[4:0]. </pre>
27	V_AND_B32	<p>Bitwise AND. Input and output modifiers not supported.</p> <pre> D.u32 = S0.u32 &amp; S1.u32. </pre>
28	V_OR_B32	<p>Bitwise OR. Input and output modifiers not supported.</p> <pre> D.u32 = S0.u32   S1.u32. </pre>
29	V_XOR_B32	<p>Bitwise XOR. Input and output modifiers not supported.</p> <pre> D.u32 = S0.u32 ^ S1.u32. </pre>

Opcode	Name	Description
30	V_XNOR_B32	Bitwise XNOR. Input and output modifiers not supported.  $D.u32 = \sim(S0.u32 \wedge S1.u32).$
37	V_ADD_NC_U32	Add two unsigned integers. No carry-in or carry-out.  $D.u32 = S0.u32 + S1.u32.$
38	V_SUB_NC_U32	Subtract the second unsigned integer from the first unsigned integer. No carry-in or carry-out.  $D.u32 = S0.u32 - S1.u32.$
39	V_SUBREV_NC_U32	Subtract the first unsigned integer from the second unsigned integer. No carry-in or carry-out.  $D.u32 = S1.u32 - S0.u32.$
40	V_ADD_CO_CI_U32	Add two unsigned integers and a carry-in from VCC. Store the result and also save the carry-out to VCC. In VOP3 the VCC destination may be an arbitrary SGPR-pair, and the VCC source comes from the SGPR-pair at S2.u.  $D.u32 = S0.u32 + S1.u32 + VCC;$ $VCC = S0.u32 + S1.u32 + VCC \geq 0x100000000ULL ? 1 : 0.$
41	V_SUB_CO_CI_U32	Subtract the second unsigned integer from the first unsigned integer and then subtract a carry-in from VCC. Store the result and also save the carry-out to VCC. In VOP3 the VCC destination may be an arbitrary SGPR-pair, and the VCC source comes from the SGPR-pair at S2.u.  $D.u32 = S0.u32 - S1.u32 - VCC;$ $VCC = S1.u32 + VCC > S0.u32 ? 1 : 0.$
42	V_SUBREV_CO_CI_U32	Subtract the first unsigned integer from the second unsigned integer and then subtract a carry-in from VCC. Store the result and also save the carry-out to VCC. In VOP3 the VCC destination may be an arbitrary SGPR-pair, and the VCC source comes from the SGPR-pair at S2.u.  $D.u32 = S1.u32 - S0.u32 - VCC;$ $VCC = S1.u32 + VCC > S0.u ? 1 : 0.$
43	V_FMAC_F32	Fused multiply-add of single-precision floats, accumulate with destination.  $D.f32 = S0.f32 * S1.f32 + D.f32. // \text{Fused operation}$
44	V_FMAMK_F32	Multiply a single-precision float with a literal constant and add a second single-precision float using fused multiply-add. This opcode cannot use the VOP3 encoding and cannot use input/output modifiers.  $D.f32 = S0.f32 * K.f32 + S1.f32. // K \text{ is a 32-bit literal constant.}$
45	V_FMAAK_F32	Multiply two single-precision floats and add a literal constant using fused multiply-add. This opcode cannot use the VOP3 encoding and cannot use input/output modifiers.  $D.f32 = S0.f32 * S1.f32 + K.f32. // K \text{ is a 32-bit literal constant.}$

Opcode	Name	Description
47	V_CVT_PKRTZ_F16_F32	<p>Convert two single-precision floats into a packed FP16 result and round to zero (ignore the current rounding mode). This opcode is intended for use with 16-bit compressed exports. See V_CVT_F16_F32 for a version that respects the current rounding mode.</p> <pre>D.f16_lo = f32_to_f16(S0.f32); D.f16_hi = f32_to_f16(S1.f32). // Round-toward-zero regardless of current round mode setting in hardware.</pre>
50	V_ADD_F16	<p>Add two FP16 values. 0.5ULP precision. Supports denormals, round mode, exception flags and saturation.</p> <pre>D.f16_lo = S0.f16_lo + S1.f16_lo.</pre>
51	V_SUB_F16	<p>Subtract the second FP16 value from the first. 0.5ULP precision, Supports denormals, round mode, exception flags and saturation.</p> <pre>D.f16_lo = S0.f16_lo - S1.f16_lo.</pre>
52	V_SUBREV_F16	<p>Subtract the first FP16 value from the second. 0.5ULP precision. Supports denormals, round mode, exception flags and saturation.</p> <pre>D.f16_lo = S1.f16_lo - S0.f16_lo.</pre>
53	V_MUL_F16	<p>Multiply two FP16 values. 0.5ULP precision. Supports denormals, round mode, exception flags and saturation.</p> <pre>D.f16_lo = S0.f16_lo * S1.f16_lo.</pre>
54	V_FMAC_F16	<p>Fused multiply-add of FP16 values, accumulate with destination. 0.5ULP precision. Supports denormals, round mode, exception flags and saturation.</p> <pre>D.f16_lo = S0.f16_lo * S1.f16_lo + D.f16_lo.</pre>
55	V_FMAMK_F16	<p>Multiply a FP16 value with a literal constant and add a second FP16 value using fused multiply-add. This opcode cannot use the VOP3 encoding and cannot use input/output modifiers. Supports round mode, exception flags, saturation.</p> <pre>D.f16_lo = S0.f16_lo * K.f16_lo + S1.f16_lo. // K is a 32-bit literal constant stored in the following literal DWORD.</pre>
56	V_FMAAK_F16	<p>Multiply two FP16 values and add a literal constant using fused multiply-add. This opcode cannot use the VOP3 encoding and cannot use input/output modifiers. Supports round mode, exception flags, saturation.</p> <pre>D.f16_lo = S0.f16_lo * S1.f16_lo + K.f16_lo. // K is a 32-bit literal constant stored in the following literal DWORD.</pre>

Opcode	Name	Description
57	V_MAX_F16	<p>Maximum of two FP16 values. IEEE compliant. Supports denormals, round mode, exception flags, saturation.</p> <pre> D.f16 = max(S0.f16,S1.f16); if (IEEE_MODE &amp;&amp; S0.f16 == sNaN)     D.f16 = Quiet(S0.f16); else if (IEEE_MODE &amp;&amp; S1.f16 == sNaN)     D.f16 = Quiet(S1.f16); else if (S0.f16 == NaN)     D.f16 = S1.f16; else if (S1.f16 == NaN)     D.f16 = S0.f16; else if (S0.f16 == +0.0 &amp;&amp; S1.f16 == -0.0)     D.f16 = S0.f16; else if (S0.f16 == -0.0 &amp;&amp; S1.f16 == +0.0)     D.f16 = S1.f16; else if (IEEE_MODE)     D.f16 = (S0.f16 &gt;= S1.f16 ? S0.f16 : S1.f16); else     D.f16 = (S0.f16 &gt; S1.f16 ? S0.f16 : S1.f16); endif. </pre>
58	V_MIN_F16	<p>Minimum of two FP16 values. IEEE compliant. Supports denormals, round mode, exception flags, saturation.</p> <pre> D.f16 = min(S0.f16,S1.f16); if (IEEE_MODE &amp;&amp; S0.f16 == sNaN)     D.f16 = Quiet(S0.f16); else if (IEEE_MODE &amp;&amp; S1.f16 == sNaN)     D.f16 = Quiet(S1.f16); else if (S0.f16 == NaN)     D.f16 = S1.f16; else if (S1.f16 == NaN)     D.f16 = S0.f16; else if (S0.f16 == +0.0 &amp;&amp; S1.f16 == -0.0)     D.f16 = S1.f16; else if (S0.f16 == -0.0 &amp;&amp; S1.f16 == +0.0)     D.f16 = S0.f16; else     // Note: there's no IEEE special case here like there is for     // V_MAX_F16.     D.f16 = (S0.f16 &lt; S1.f16 ? S0.f16 : S1.f16); endif. </pre>
59	V_LDEXP_F16	<p>Multiply an FP16 value by an integral power of 2, compare with the ldexp() function in C. Note that the S1 has a format of f16 since floating point literal constants are interpreted as 16 bit value for this opcode.</p> <pre> D.f16 = S0.f16 * (2 ** S1.i16). </pre>
60	V_PK_FMAC_F16	<p>Multiply packed FP16 values and accumulate with destination. VOP2 version of V_PK_FMA_F16 with third source VGPR address is the destination.</p> <pre> D.f16_lo = S0.f16_lo * S1.f16_lo + D.f16_lo; D.f16_hi = S0.f16_hi * S1.f16_hi + D.f16_hi. </pre>



### 12.7.1. VOP2 using VOP3 encoding

Instructions in this format may also be encoded as VOP3. VOP3 allows access to the extra control bits (e.g. ABS, OMOD) at the expense of a larger instruction word. The VOP3 opcode is: VOP2 opcode + 0x100.

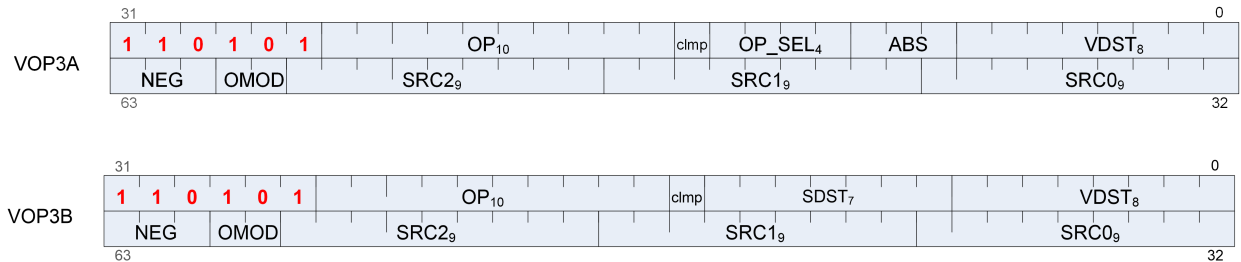

## 12.8. VOP1 Instructions



Instructions in this format may use a 32-bit literal constant, DPP or SDWA which occurs immediately after the instruction.

Opcode	Name	Description
0	V_NOP	Do nothing, with style!
1	V_MOV_B32	Move data to a VGPR. Floating-point modifiers are valid for this instruction if S0.u is a 32-bit floating point value. This instruction is suitable for negating or taking the absolute value of a floating-point value.  D.u = S0.u.  Examples: v_mov_b32 v0, v1 // Move v1 to v0 v_mov_b32 v0, -v1 // Set v1 to the negation of v0 v_mov_b32 v0, abs(v1) // Set v1 to the absolute value of v0
2	V_READFIRSTLANE_B32	Copy one VGPR value to one SGPR. D = SGPR destination, S0 = source data (VGPR# or M0 for lds direct access), Lane# = FindFirst1fromLSB(exec) (Lane# = 0 if exec is zero). Ignores exec mask for the access. Input and output modifiers not supported; this is an untyped operation.
3	V_CVT_I32_F64	Convert from a double-precision float to a signed integer. 0.5ULP accuracy, out-of-range floating point values (including infinity) saturate. NaN is converted to 0. Generation of the INEXACT exception is controlled by the CLAMP bit. INEXACT exceptions are enabled for this conversion iff CLAMP == 1.  D.i = (int)S0.d.

Opcode	Name	Description
4	V_CVT_F64_I32	Convert from a signed integer to a double-precision float, 0ULP accuracy.  D.d = (double)S0.i.
5	V_CVT_F32_I32	Convert from a signed integer to a single-precision float, 0.5ULP accuracy.  D.f = (float)S0.i.
6	V_CVT_F32_U32	Convert from an unsigned integer to a single-precision float, 0.5ULP accuracy.  D.f = (float)S0.u.
7	V_CVT_U32_F32	Convert from a single-precision float to an unsigned integer. 1ULP accuracy, out-of-range floating point values (including infinity) saturate. NaN is converted to 0. Generation of the INEXACT exception is controlled by the CLAMP bit. INEXACT exceptions are enabled for this conversion iff CLAMP == 1.  D.u = (unsigned)S0.f.
8	V_CVT_I32_F32	Convert from a single-precision float to a signed integer. 1ULP accuracy, out-of-range floating point values (including infinity) saturate. NaN is converted to 0. Generation of the INEXACT exception is controlled by the CLAMP bit. INEXACT exceptions are enabled for this conversion iff CLAMP == 1.  D.i = (int)S0.f.
10	V_CVT_F16_F32	Convert from a single-precision float to an FP16 float. 0.5ULP accuracy, supports input modifiers and creates FP16 denormals when appropriate.  D.f16 = flt32_to_flt16(S0.f).
11	V_CVT_F32_F16	Convert from an FP16 float to a single-precision float. 0ULP accuracy, FP16 denormal inputs are accepted.  D.f = flt16_to_flt32(S0.f16).
12	V_CVT_RPI_I32_F32	Convert from a single-precision float to a signed integer, round to nearest integer. 0.5ULP accuracy, denormals are supported.  D.i = (int)floor(S0.f + 0.5).
13	V_CVT_FLR_I32_F32	Convert from a single-precision float to a signed integer, round down. 1ULP accuracy, denormals are supported.  D.i = (int)floor(S0.f).

Opcode	Name	Description
14	V_CVT_OFF_F32_I4	4-bit signed int to 32-bit float. Used for interpolation in shader.  S0__Result__ 1000 -0.5000f 1001 -0.4375f 1010 -0.3750f 1011 -0.3125f 1100 -0.2500f 1101 -0.1875f 1110 -0.1250f 1111 -0.0625f 0000 +0.0000f 0001 +0.0625f 0010 +0.1250f 0011 +0.1875f 0100 +0.2500f 0101 +0.3125f 0110 +0.3750f 0111 +0.4375f
15	V_CVT_F32_F64	Convert from a double-precision float to a single-precision float. 0.5ULP accuracy, denormals are supported.  D.f = (float)S0.d.
16	V_CVT_F64_F32	Convert from a single-precision float to a double-precision float. 0ULP accuracy, denormals are supported.  D.d = (double)S0.f.
17	V_CVT_F32_UBYTE0	Convert an unsigned byte (byte 0) to a single-precision float.  D.f = (float)(S0.u[7:0]).
18	V_CVT_F32_UBYTE1	Convert an unsigned byte (byte 1) to a single-precision float.  D.f = (float)(S0.u[15:8]).
19	V_CVT_F32_UBYTE2	Convert an unsigned byte (byte 2) to a single-precision float.  D.f = (float)(S0.u[23:16]).
20	V_CVT_F32_UBYTE3	Convert an unsigned byte (byte 3) to a single-precision float.  D.f = (float)(S0.u[31:24]).
21	V_CVT_U32_F64	Convert from a double-precision float to an unsigned integer. 0.5ULP accuracy, out-of-range floating point values (including infinity) saturate. NaN is converted to 0. Generation of the INEXACT exception is controlled by the CLAMP bit. INEXACT exceptions are enabled for this conversion iff CLAMP == 1.  D.u = (unsigned)S0.d.
22	V_CVT_F64_U32	Convert from an unsigned integer to a double-precision float. 0ULP accuracy.  D.d = (double)S0.u.

Opcode	Name	Description
23	V_TRUNC_F64	Return integer part of S0.d, round-to-zero semantics.  D.d = trunc(S0.d).
24	V_CEIL_F64	Round up to next whole integer.  D.d = trunc(S0.d); if(S0.d > 0.0 && S0.d != D.d) then D.d += 1.0; endif.
25	V_RNDNE_F64	Round-to-nearest-even semantics.  D.d = floor(S0.d + 0.5); if(floor(S0.d) is even && fract(S0.d) == 0.5) then D.d -= 1.0; endif.
26	V_FLOOR_F64	Round down to previous whole integer.  D.d = trunc(S0.d); if(S0.d < 0.0 && S0.d != D.d) then D.d += -1.0; endif.
27	V_PIPEFLUSH	Flush the VALU destination cache.
32	V_FRACT_F32	Return fractional portion of a number. 0.5ULP accuracy, denormals are accepted.  D.f = S0.f + -floor(S0.f).  NOTE: This complies with the DX specification of fract where the function behaves like an extension of integer modulus; be aware this may differ from how fract() is defined in other domains. For example: fract(-1.2) = 0.8 in DX.
33	V_TRUNC_F32	Return integer part of S0.f, round-to-zero semantics.  D.f = trunc(S0.f).
34	V_CEIL_F32	Round up to next whole integer.  D.f = trunc(S0.f); if(S0.f > 0.0 && S0.f != D.f) then D.f += 1.0; endif.
35	V_RNDNE_F32	Round-to-nearest-even semantics.  D.f = floor(S0.f + 0.5); if(floor(S0.f) is even && fract(S0.f) == 0.5) then D.f -= 1.0; endif.
36	V_FLOOR_F32	Round down to previous whole integer.  D.f = trunc(S0.f); if(S0.f < 0.0 && S0.f != D.f) then D.f += -1.0; endif.

Opcode	Name	Description
37	V_EXP_F32	<p>Base 2 exponentiation. 1ULP accuracy, denormals are flushed.</p> $D.f = \text{pow}(2.0, S0.f).$ <p>Functional examples:</p> <pre>V_EXP_F32(0xff800000) =&gt; 0x00000000 // exp(-INF) = 0 V_EXP_F32(0x80000000) =&gt; 0x3f800000 // exp(-0.0) = 1 V_EXP_F32(0x7f800000) =&gt; 0x7f800000 // exp(+INF) = +INF</pre>
39	V_LOG_F32	<p>Base 2 logarithm. 1ULP accuracy, denormals are flushed.</p> $D.f = \log_2(S0.f).$ <p>Functional examples:</p> <pre>V_LOG_F32(0xff800000) =&gt; 0xffc00000 // log(-INF) = NAN V_LOG_F32(0xbf800000) =&gt; 0xffc00000 // log(-1.0) = NAN V_LOG_F32(0x80000000) =&gt; 0xff800000 // log(-0.0) = -INF V_LOG_F32(0x00000000) =&gt; 0xff800000 // log(+0.0) = -INF V_LOG_F32(0x3f800000) =&gt; 0x00000000 // log(+1.0) = 0 V_LOG_F32(0x7f800000) =&gt; 0x7f800000 // log(+INF) = +INF</pre>
42	V_RCP_F32	<p>Compute reciprocal with IEEE rules. 1ULP accuracy. Accuracy converges to &lt; 0.5ULP when using the Newton-Raphson method and 2 FMA operations. Denormals are flushed.</p> $D.f = 1.0 / S0.f.$ <p>Functional examples:</p> <pre>V_RCP_F32(0xff800000) =&gt; 0x80000000 // rcp(-INF) = -0 V_RCP_F32(0xc0000000) =&gt; 0xbf000000 // rcp(-2.0) = -0.5 V_RCP_F32(0x80000000) =&gt; 0xff800000 // rcp(-0.0) = -INF V_RCP_F32(0x00000000) =&gt; 0x7f800000 // rcp(+0.0) = +INF V_RCP_F32(0x7f800000) =&gt; 0x00000000 // rcp(+INF) = +0</pre>
43	V_RCP_IFLAG_F32	<p>Compute reciprocal as part of integer divide. Can raise integer DIV_BY_ZERO exception but cannot raise floating-point exceptions. To be used in an integer reciprocal macro by the compiler with one of the following sequences:</p> $D.f = 1.0 / S0.f.$ <p>Unsigned usage:</p> <pre>CVT_F32_U32 RCP_IFLAG_F32 MUL_F32 (2**32 - 1) CVT_U32_F32</pre> <p>Signed usage:</p> <pre>CVT_F32_I32 RCP_IFLAG_F32 MUL_F32 (2**31 - 1) CVT_I32_F32</pre>

Opcode	Name	Description
46	V_RSQ_F32	<p>Reciprocal square root with IEEE rules. 1ULP accuracy, denormals are flushed.</p> $D.f = 1.0 / \text{sqrt}(S0.f).$ <p>Functional examples:</p> <pre>V_RSQ_F32(0xff800000) =&gt; 0xffc00000 // rsq(-INF) = NAN V_RSQ_F32(0x80000000) =&gt; 0xff800000 // rsq(-0.0) = -INF V_RSQ_F32(0x00000000) =&gt; 0x7f800000 // rsq(+0.0) = +INF V_RSQ_F32(0x40800000) =&gt; 0x3f000000 // rsq(+4.0) = +0.5 V_RSQ_F32(0x7f800000) =&gt; 0x00000000 // rsq(+INF) = +0</pre>
47	V_RCP_F64	<p>Reciprocal with IEEE rules. Precision is (2**29) ULP, and supports denormals.</p> $D.d = 1.0 / S0.d.$
49	V_RSQ_F64	<p>Reciprocal square root with IEEE rules. Precision is (2**29) ULP, and supports denormals.</p> $D.f16 = 1.0 / \text{sqrt}(S0.f16).$
51	V_SQRT_F32	<p>Square root. 1ULP accuracy, denormals are flushed.</p> $D.f = \text{sqrt}(S0.f).$ <p>Functional examples:</p> <pre>V_SQRT_F32(0xff800000) =&gt; 0xffc00000 // sqrt(-INF) = NAN V_SQRT_F32(0x80000000) =&gt; 0x80000000 // sqrt(-0.0) = -0 V_SQRT_F32(0x00000000) =&gt; 0x00000000 // sqrt(+0.0) = +0 V_SQRT_F32(0x40800000) =&gt; 0x40000000 // sqrt(+4.0) = +2.0 V_SQRT_F32(0x7f800000) =&gt; 0x7f800000 // sqrt(+INF) = +INF</pre>
52	V_SQRT_F64	<p>Square root. Precision is (2**29) ULP, and supports denormals.</p> $D.d = \text{sqrt}(S0.d).$
53	V_SIN_F32	<p>Trigonometric sine. Denormals are supported.</p> $D.f = \sin(S0.f * 2 * \text{PI}).$ <p>Functional examples:</p> <pre>V_SIN_F32(0xff800000) =&gt; 0xffc00000 // sin(-INF) = NAN V_SIN_F32(0xff7fffff) =&gt; 0x00000000 // -MaxFloat, finite V_SIN_F32(0x80000000) =&gt; 0x80000000 // sin(-0.0) = -0 V_SIN_F32(0x3e800000) =&gt; 0x3f800000 // sin(0.25) = 1 V_SIN_F32(0x7f800000) =&gt; 0xffc00000 // sin(+INF) = NAN</pre>

Opcode	Name	Description
54	V_COS_F32	<p>Trigonometric cosine. Denormals are supported.</p> <p><math>D.f = \cos(S0.f * 2 * \text{PI}).</math></p> <p>Functional examples:</p> <pre>V_COS_F32(0xff800000) =&gt; 0xffc00000 // cos(-INF) = NAN V_COS_F32(0xff7fffff) =&gt; 0x3f800000 // -MaxFloat, finite V_COS_F32(0x80000000) =&gt; 0x3f800000 // cos(-0.0) = 1 V_COS_F32(0x3e800000) =&gt; 0x00000000 // cos(0.25) = 0 V_COS_F32(0x7f800000) =&gt; 0xffc00000 // cos(+INF) = NAN</pre>
55	V_NOT_B32	<p>Bitwise negation. Input and output modifiers not supported.</p> <p><math>D.u = \sim S0.u.</math></p>
56	V_BFREV_B32	<p>Bitfield reverse. Input and output modifiers not supported.</p> <p><math>D.u[31:0] = S0.u[0:31].</math></p>
57	V_FFBH_U32	<p>Counts how many zeros before the first one starting from the MSB. Returns -1 if there are no ones.</p> <pre>D.i = -1; // Set if no ones are found for i in 0 ... 31 do   // Note: search is from the MSB   if S0.u[31 - i] == 1 then     D.i = i;     break for;   endif; endfor.</pre> <p>Functional examples:</p> <pre>V_FFBH_U32(0x00000000) =&gt; 0xffffffff V_FFBH_U32(0x800000ff) =&gt; 0 V_FFBH_U32(0x100000ff) =&gt; 3 V_FFBH_U32(0x0000ffff) =&gt; 16 V_FFBH_U32(0x00000001) =&gt; 31</pre>
58	V_FFBL_B32	<p>Returns the bit position of the first one from the LSB, or -1 if there are no ones.</p> <pre>D.i = -1; // Set if no ones are found for i in 0 ... 31 do // Search from LSB   if S0.u[i] == 1 then     D.i = i;     break for;   endif; endfor.</pre> <p>Functional examples:</p> <pre>V_FFBL_B32(0x00000000) =&gt; 0xffffffff V_FFBL_B32(0xff000001) =&gt; 0 V_FFBL_B32(0xff000008) =&gt; 3 V_FFBL_B32(0xffff0000) =&gt; 16 V_FFBL_B32(0x80000000) =&gt; 31</pre>

Opcode	Name	Description
59	V_FFBH_I32	<p>Counts how many bits in a row (from MSB to LSB) are the same as the sign bit. Returns -1 if all bits are the same.</p> <pre> D.i = -1; // Set if all bits are the same for i in 1 ... 31 do   // Note: search is from the MSB   if S0.i[31 - i] != S0.i[31] then     D.i = i;     break for;   endif; endfor. </pre> <p>Functional examples:</p> <pre> V_FFBH_I32(0x00000000) =&gt; 0xffffffff V_FFBH_I32(0x40000000) =&gt; 1 V_FFBH_I32(0x80000000) =&gt; 1 V_FFBH_I32(0xffffffff) =&gt; 4 V_FFBH_I32(0xffff0000) =&gt; 16 V_FFBH_I32(0xfffffffffe) =&gt; 31 V_FFBH_I32(0xffffffffff) =&gt; 0xffffffff </pre>
60	V_FREXP_EXP_I32_F64	<p>Returns exponent of single precision float input, such that <math>S0.d = \text{significand} * (2 ** \text{exponent})</math>. See also V_FREXP_MANT_F64, which returns the significand. See the C library function <code>frexp()</code> for more information.</p> <pre> if(S0.f64 == +-INF    S0.f64 == NAN)   D.i32 = 0; else   D.i32 = S0.f64.exp - 1023 + 1; endif. </pre>
61	V_FREXP_MANT_F64	<p>Returns binary significand of double precision float input, such that <math>S0.d = \text{significand} * (2 ** \text{exponent})</math>. Result range is in <math>(-1.0, -0.5][0.5, 1.0)</math> in normal cases. See also V_FREXP_EXP_I32_F64, which returns integer exponent. See the C library function <code>frexp()</code> for more information.</p> <pre> if(S0.d == +-INF    S0.d == NAN) then   D.d = S0.d; else   D.d = Mantissa(S0.d); endif. </pre>
62	V_FRACT_F64	<p>Return fractional portion of a number. 0.5ULP accuracy, denormals are accepted.</p> <pre> D.d = S0.d + -floor(S0.d). </pre> <p>NOTE: This complies with the DX specification of <code>fract</code> where the function behaves like an extension of integer modulus; be aware this may differ from how <code>fract()</code> is defined in other domains. For example: <code>fract(-1.2) = 0.8</code> in DX.</p>



Opcode	Name	Description
63	V_FREXP_EXP_I32_F32	<p>Returns exponent of single precision float input, such that <math>S0.f = \text{significand} * (2 ** \text{exponent})</math>. See also V_FREXP_MANT_F32, which returns the significand. See the C library function <code>frexp()</code> for more information.</p> <pre> if(S0.f == +-INF    S0.f == NAN) then   D.i = 0; else   D.i = TwosComplement(Exponent(S0.f) - 127 + 1); endif. </pre>
64	V_FREXP_MANT_F32	<p>Returns binary significand of single precision float input, such that <math>S0.f = \text{significand} * (2 ** \text{exponent})</math>. Result range is in <math>(-1.0, -0.5][0.5, 1.0)</math> in normal cases. See also V_FREXP_EXP_I32_F32, which returns integer exponent. See the C library function <code>frexp()</code> for more information.</p> <pre> if(S0.f == +-INF    S0.f == NAN) then   D.f = S0.f; else   D.f = Mantissa(S0.f); endif. </pre>
65	V_CLREXCP	Clear this wave's exception state in the SIMD (SP).
66	V_MOVRELD_B32	<p>Move to a relative destination address.</p> <pre> addr = VGPR address appearing in instruction DST field; addr += M0.u[31:0]; VGPR[addr].u = S0.u. </pre> <p>Example: The following instruction sequence will perform a move <code>v15 &lt;== v7</code>:</p> <pre> s_mov_b32 m0, 10 v_movreld_b32 v5, v7 </pre>
67	V_MOVRELS_B32	<p>Move from a relative source address.</p> <pre> addr = VGPR address appearing in instruction SRC0 field; addr += M0.u[31:0]; D.u = VGPR[addr].u. </pre> <p>Example: The following instruction sequence will perform a move <code>v5 &lt;== v17</code>:</p> <pre> s_mov_b32 m0, 10 v_movrels_b32 v5, v7 </pre>

Opcode	Name	Description
68	V_MOVRELSB_B32	<p>Move from a relative source address to a relative destination address.</p> <pre> addr_src = VGPR address appearing in instruction SRC0 field; addr_src += M0.u[31:0]; addr_dst = VGPR address appearing in instruction DST field; addr_dst += M0.u[31:0]; VGPR[addr_dst].u = VGPR[addr_src].u. </pre> <p>Example: The following instruction sequence will perform a move <code>v15 &lt;== v17</code>:</p> <pre> s_mov_b32 m0, 10 v_movreldb_b32 v5, v7 </pre>
72	V_MOVRELSB_2_B32	<p>Move from a relative source address to a relative destination address, with different relative offsets.</p> <pre> addr_src = VGPR address appearing in instruction SRC0 field; addr_src += M0.u[9:0]; addr_dst = VGPR address appearing in instruction DST field; addr_dst += M0.u[25:16]; VGPR[addr_dst].u = VGPR[addr_src].u. </pre> <p>Example: The following instruction sequence will perform a move <code>v25 &lt;== v17</code>:</p> <pre> s_mov_b32 m0, ((20 &lt;&lt; 16)   10) v_movreldb_2_b32 v5, v7 </pre>
80	V_CVT_F16_U16	<p>Convert from an unsigned short to an FP16 float. 0.5ULP accuracy, supports denormals, rounding, exception flags and saturation.</p> <pre> D.f16 = uint16_to_flt16(S.u16). </pre>
81	V_CVT_F16_I16	<p>Convert from a signed short to an FP16 float. 0.5ULP accuracy, supports denormals, rounding, exception flags and saturation.</p> <pre> D.f16 = int16_to_flt16(S.i16). </pre>
82	V_CVT_U16_F16	<p>Convert from an FP16 float to an unsigned short. 1ULP accuracy, supports rounding, exception flags and saturation. FP16 denormals are accepted. Conversion is done with truncation. Generation of the INEXACT exception is controlled by the CLAMP bit. INEXACT exceptions are enabled for this conversion iff <code>CLAMP == 1</code>.</p> <pre> D.u16 = flt16_to_uint16(S.f16). </pre>
83	V_CVT_I16_F16	<p>Convert from an FP16 float to a signed short. 1ULP accuracy, supports rounding, exception flags and saturation. FP16 denormals are accepted. Conversion is done with truncation. Generation of the INEXACT exception is controlled by the CLAMP bit. INEXACT exceptions are enabled for this conversion iff <code>CLAMP == 1</code>.</p> <pre> D.i16 = flt16_to_int16(S.f16). </pre>

Opcode	Name	Description
84	V_RCP_F16	<p>Reciprocal with IEEE rules. 0.51ULP accuracy.</p> $D.f16 = 1.0 / S0.f16.$ <p>Functional examples:</p> <pre>V_RCP_F16(0xfc00) =&gt; 0x8000 // rcp(-INF) = -0 V_RCP_F16(0xc000) =&gt; 0xb800 // rcp(-2.0) = -0.5 V_RCP_F16(0x8000) =&gt; 0xfc00 // rcp(-0.0) = -INF V_RCP_F16(0x0000) =&gt; 0x7c00 // rcp(+0.0) = +INF V_RCP_F16(0x7c00) =&gt; 0x0000 // rcp(+INF) = +0</pre>
85	V_SQRT_F16	<p>Square root. 0.51ULP accuracy, denormals are supported.</p> $D.f16 = \text{sqrt}(S0.f16).$ <p>Functional examples:</p> <pre>V_SQRT_F16(0xfc00) =&gt; 0xfe00 // sqrt(-INF) = NAN V_SQRT_F16(0x8000) =&gt; 0x8000 // sqrt(-0.0) = -0 V_SQRT_F16(0x0000) =&gt; 0x0000 // sqrt(+0.0) = +0 V_SQRT_F16(0x4400) =&gt; 0x4000 // sqrt(+4.0) = +2.0 V_SQRT_F16(0x7c00) =&gt; 0x7c00 // sqrt(+INF) = +INF</pre>
86	V_RSQ_F16	<p>Reciprocal square root with IEEE rules. 0.51ULP accuracy, denormals are supported.</p> $D.f16 = 1.0 / \text{sqrt}(S0.f16).$ <p>Functional examples:</p> <pre>V_RSQ_F16(0xfc00) =&gt; 0xfe00 // rsq(-INF) = NAN V_RSQ_F16(0x8000) =&gt; 0xfc00 // rsq(-0.0) = -INF V_RSQ_F16(0x0000) =&gt; 0x7c00 // rsq(+0.0) = +INF V_RSQ_F16(0x4400) =&gt; 0x3800 // rsq(+4.0) = +0.5 V_RSQ_F16(0x7c00) =&gt; 0x0000 // rsq(+INF) = +0</pre>
87	V_LOG_F16	<p>Base 2 logarithm. 0.51ULP accuracy, denormals are supported.</p> $D.f16 = \log_2(S0.f).$ <p>Functional examples:</p> <pre>V_LOG_F16(0xfc00) =&gt; 0xfe00 // log(-INF) = NAN V_LOG_F16(0xbc00) =&gt; 0xfe00 // log(-1.0) = NAN V_LOG_F16(0x8000) =&gt; 0xfc00 // log(-0.0) = -INF V_LOG_F16(0x0000) =&gt; 0xfc00 // log(+0.0) = -INF V_LOG_F16(0x3c00) =&gt; 0x0000 // log(+1.0) = 0 V_LOG_F16(0x7c00) =&gt; 0x7c00 // log(+INF) = +INF</pre>

Opcode	Name	Description
88	V_EXP_F16	<p>Base 2 exponentiation. 0.51ULP accuracy, denormals are supported.</p> <p><math>D.f16 = \text{pow}(2.0, S0.f16).</math></p> <p>Functional examples:</p> <pre>V_EXP_F16(0xfc00) =&gt; 0x0000 // exp(-INF) = 0 V_EXP_F16(0x8000) =&gt; 0x3c00 // exp(-0.0) = 1 V_EXP_F16(0x7c00) =&gt; 0x7c00 // exp(+INF) = +INF</pre>
89	V_FREXP_MANT_F16	<p>Returns binary significand of half precision float input, such that <math>S0.f16 = \text{significand} * (2 ** \text{exponent})</math>. Result range is in <math>(-1.0, -0.5][0.5, 1.0)</math> in normal cases. See also V_FREXP_EXP_I16_F16, which returns integer exponent. See the C library function <code>frexp()</code> for more information.</p> <pre>if(S0.f16 == +-INF    S0.f16 == NAN) then   D.f16 = S0.f16; else   D.f16 = Mantissa(S0.f16); endif.</pre>
90	V_FREXP_EXP_I16_F16	<p>Returns exponent of half precision float input, such that <math>S0.f16 = \text{significand} * (2 ** \text{exponent})</math>. See also V_FREXP_MANT_F16, which returns the significand. See the C library function <code>frexp()</code> for more information.</p> <pre>if(S0.f16 == +-INF    S0.f16 == NAN) then   D.i = 0; else   D.i = TwosComplement(Exponent(S0.f16) - 15 + 1); endif.</pre>
91	V_FLOOR_F16	<p>Round down to previous whole integer.</p> <pre>D.f16 = trunc(S0.f16); if(S0.f16 &lt; 0.0f &amp;&amp; S0.f16 != D.f16) then   D.f16 -= 1.0; endif.</pre>
92	V_CEIL_F16	<p>Round up to next whole integer.</p> <pre>D.f16 = trunc(S0.f16); if(S0.f16 &gt; 0.0f &amp;&amp; S0.f16 != D.f16) then   D.f16 += 1.0; endif.</pre>
93	V_TRUNC_F16	<p>Return integer part of <math>S0.f16</math>, round-to-zero semantics.</p> <pre>D.f16 = trunc(S0.f16).</pre>
94	V_RNDNE_F16	<p>Round-to-nearest-even semantics.</p> <pre>D.f16 = floor(S0.f16 + 0.5); if(floor(S0.f16) is even &amp;&amp; fract(S0.f16) == 0.5) then   D.f16 -= 1.0; endif.</pre>

Opcode	Name	Description
95	V_FRACT_F16	<p>Return fractional portion of a number. 0.5ULP accuracy, denormals are accepted.</p> $D.f16 = S0.f16 + \text{-floor}(S0.f16).$ <p>NOTE: This complies with the DX specification of fract where the function behaves like an extension of integer modulus; be aware this may differ from how fract() is defined in other domains. For example: fract(-1.2) = 0.8 in DX.</p>
96	V_SIN_F16	<p>Trigonometric sine. Denormals are supported.</p> $D.f16 = \sin(S0.f16 * 2 * \text{PI}).$ <p>Functional examples:</p> <pre>V_SIN_F16(0xfc00) =&gt; 0xfe00 // sin(-INF) = NAN V_SIN_F16(0xfbff) =&gt; 0x0000 // Most negative finite FP16 V_SIN_F16(0x8000) =&gt; 0x8000 // sin(-0.0) = -0 V_SIN_F16(0x3400) =&gt; 0x3c00 // sin(0.25) = 1 V_SIN_F16(0x7bff) =&gt; 0x0000 // Most positive finite FP16 V_SIN_F16(0x7c00) =&gt; 0xfe00 // sin(+INF) = NAN</pre>
97	V_COS_F16	<p>Trigonometric cosine. Denormals are supported.</p> $D.f16 = \cos(S0.f16 * 2 * \text{PI}).$ <p>Functional examples:</p> <pre>V_COS_F16(0xfc00) =&gt; 0xfe00 // cos(-INF) = NAN V_COS_F16(0xfbff) =&gt; 0x3c00 // Most negative finite FP16 V_COS_F16(0x8000) =&gt; 0x3c00 // cos(-0.0) = 1 V_COS_F16(0x3400) =&gt; 0x0000 // cos(0.25) = 0 V_COS_F16(0x7bff) =&gt; 0x3c00 // Most positive finite FP16 V_COS_F16(0x7c00) =&gt; 0xfe00 // cos(+INF) = NAN</pre>
98	V_SAT_PK_U8_I16	<p>Packed 8-bit saturating add.</p> $D.u32 = \{16'b0, \text{sat8}(S.u[31:16]), \text{sat8}(S.u[15:0])\}.$
99	V_CVT_NORM_I16_F16	<p>Convert from an FP16 float to a signed normalized short. 0.5ULP accuracy, supports rounding, exception flags and saturation, denormals are supported.</p> $D.i16 = \text{flt16\_to\_snorm16}(S.f16).$
100	V_CVT_NORM_U16_F16	<p>Convert from an FP16 float to an unsigned normalized short. 0.5ULP accuracy, supports rounding, exception flags and saturation, denormals are supported.</p> $D.u16 = \text{flt16\_to\_unorm16}(S.f16).$
101	V_SWAP_B32	<p>Swap operands. Input and output modifiers not supported; this is an untyped operation.</p> <pre>tmp = D.u; D.u = S0.u; S0.u = tmp.</pre>

Opcode	Name	Description
104	V_SWAPREL_B32	<p>Swap operands. Input and output modifiers not supported; this is an untyped operation. The two addresses are relatively indexed using M0.</p> <pre> addr_src = VGPR address appearing in instruction SRC0 field; addr_src += M0.u[9:0]; addr_dst = VGPR address appearing in instruction DST field; addr_dst += M0.u[25:16]; tmp = VGPR[addr_dst]; VGPR[addr_dst] = VGPR[addr_src]; VGPR[addr_src] = tmp.                     </pre> <p>Example: The following instruction sequence will swap v25 and v17:</p> <pre> s_mov_b32 m0, ((20 &lt;&lt; 16)   10) v_swaprel_b32 v5, v7                     </pre>

### 12.8.1. VOP1 using VOP3 encoding

Instructions in this format may also be encoded as VOP3. VOP3 allows access to the extra control bits (e.g. ABS, OMOD) at the expense of a larger instruction word. The VOP3 opcode is: VOP2 opcode + 0x180.

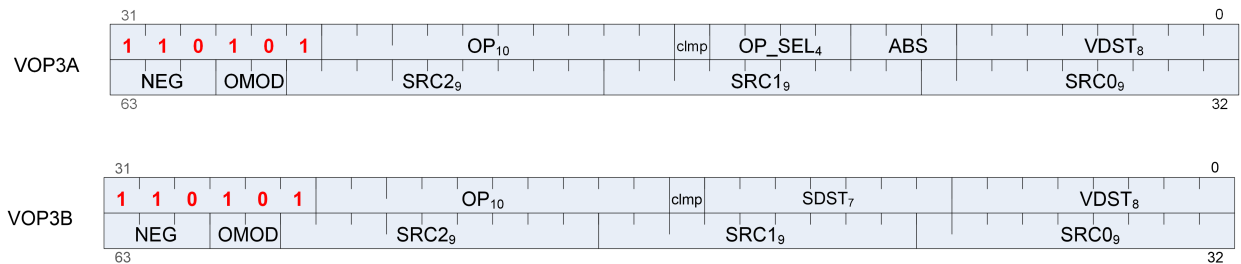

## 12.9. VOPC Instructions

The bitfield map for VOPC is:



where:

SRC0 = First operand for instruction.

VSRC1 = Second operand for instruction.

OP = Instruction opcode.

All VOPC instructions can alternatively be encoded in the VOP3A format.

Compare instructions perform the same compare operation on each lane (workItem or thread) using that lane's private data, and producing a 1 bit result per lane into VCC or EXEC.

Instructions in this format may use a 32-bit literal constant or SDWA which occurs immediately after the instruction.

Most compare instructions fall into one of two categories:

- Those which can use one of 16 compare operations (floating point types). "{COMPF}"
- Those which can use one of 8 compare operations (integer types). "{COMPI}"

The opcode number is such that for these the opcode number can be calculated from a base opcode number for the data type, plus an offset for the specific compare operation.

*Table 57. Sixteen Compare Operations*

Compare Operation	Opcode Offset	Description
F	0	D.u = 0
LT	1	D.u = (S0 < S1)
EQ	2	D.u = (S0 == S1)
LE	3	D.u = (S0 <= S1)
GT	4	D.u = (S0 > S1)
LG	5	D.u = (S0 <> S1)
GE	6	D.u = (S0 >= S1)
O	7	D.u = (!isNaN(S0) && !isNaN(S1))
U	8	D.u = (!isNaN(S0)    !isNaN(S1))
NGE	9	D.u = !(S0 >= S1)
NLG	10	D.u = !(S0 <> S1)
NGT	11	D.u = !(S0 > S1)
NLE	12	D.u = !(S0 <= S1)
NEQ	13	D.u = !(S0 == S1)
NLT	14	D.u = !(S0 < S1)
TRU	15	D.u = 1

*Table 58. Instructions with Sixteen Compare Operations*

Instruction	Description	Hex Range
V_CMP_{COMPF}_F16	16-bit float compare.	0x20 to 0x2F
V_CMPX_{COMPF}_F16	16-bit float compare. Also writes EXEC.	0x30 to 0x3F
V_CMP_{COMPF}_F32	32-bit float compare.	0x40 to 0x4F
V_CMPX_{COMPF}_F32	32-bit float compare. Also writes EXEC.	0x50 to 0x5F
V_CMPS_{COMPF}_F64	64-bit float compare.	0x60 to 0x6F
V_CMPSX_{COMPF}_F64	64-bit float compare. Also writes EXEC.	0x70 to 0x7F

Table 59. Eight Compare Operations

Compare Operation	Opcode Offset	Description
F	0	D.u = 0
LT	1	D.u = (S0 < S1)
EQ	2	D.u = (S0 == S1)
LE	3	D.u = (S0 <= S1)
GT	4	D.u = (S0 > S1)
LG	5	D.u = (S0 <> S1)
GE	6	D.u = (S0 >= S1)
TRU	7	D.u = 1

Table 60. Instructions with Eight Compare Operations

Instruction	Description	Hex Range
V_CMP_{COMPI}_I16	16-bit signed integer compare.	0xA0 - 0xA7
V_CMP_{COMPI}_U16	16-bit signed integer compare. Also writes EXEC.	0xA8 - 0xAF
V_CMPX_{COMPI}_I16	16-bit unsigned integer compare.	0xB0 - 0xB7
V_CMPX_{COMPI}_U16	16-bit unsigned integer compare. Also writes EXEC.	0xB8 - 0xBF
V_CMP_{COMPI}_I32	32-bit signed integer compare.	0xC0 - 0xC7
V_CMP_{COMPI}_U32	32-bit signed integer compare. Also writes EXEC.	0xC8 - 0xCF
V_CMPX_{COMPI}_I32	32-bit unsigned integer compare.	0xD0 - 0xD7
V_CMPX_{COMPI}_U32	32-bit unsigned integer compare. Also writes EXEC.	0xD8 - 0xDF
V_CMP_{COMPI}_I64	64-bit signed integer compare.	0xE0 - 0xE7
V_CMP_{COMPI}_U64	64-bit signed integer compare. Also writes EXEC.	0xE8 - 0xEF
V_CMPX_{COMPI}_I64	64-bit unsigned integer compare.	0xF0 - 0xF7
V_CMPX_{COMPI}_U64	64-bit unsigned integer compare. Also writes EXEC.	0xF8 - 0xFF

Table 61. VOPC Compare Opcodes

Opcode	Name	Description
0	V_CMP_F_F32	D[threadId] = 0. // D = VCC in VOPC encoding.
1	V_CMP_LT_F32	D[threadId] = (S0 < S1). // D = VCC in VOPC encoding.
2	V_CMP_EQ_F32	D[threadId] = (S0 == S1). // D = VCC in VOPC encoding.
3	V_CMP_LE_F32	D[threadId] = (S0 <= S1). // D = VCC in VOPC encoding.
4	V_CMP_GT_F32	D[threadId] = (S0 > S1). // D = VCC in VOPC encoding.



Opcode	Name	Description
5	V_CMP_LG_F32	D[threadId] = (S0 <> S1). // D = VCC in VOPC encoding.
6	V_CMP_GE_F32	D[threadId] = (S0 >= S1). // D = VCC in VOPC encoding.
7	V_CMP_O_F32	D[threadId] = (!isNan(S0) && !isNan(S1)). // D = VCC in VOPC encoding.
8	V_CMP_U_F32	D[threadId] = (isNan(S0)    isNan(S1)). // D = VCC in VOPC encoding.
9	V_CMP_NGE_F32	D[threadId] = !(S0 >= S1) // With NAN inputs this is not the same operation as <. // D = VCC in VOPC encoding.
10	V_CMP_NLG_F32	D[threadId] = !(S0 <> S1) // With NAN inputs this is not the same operation as ==. // D = VCC in VOPC encoding.
11	V_CMP_NGT_F32	D[threadId] = !(S0 > S1) // With NAN inputs this is not the same operation as <=. // D = VCC in VOPC encoding.
12	V_CMP_NLE_F32	D[threadId] = !(S0 <= S1) // With NAN inputs this is not the same operation as >. // D = VCC in VOPC encoding.
13	V_CMP_NEQ_F32	D[threadId] = !(S0 == S1) // With NAN inputs this is not the same operation as !=. // D = VCC in VOPC encoding.
14	V_CMP_NLT_F32	D[threadId] = !(S0 < S1) // With NAN inputs this is not the same operation as >=. // D = VCC in VOPC encoding.
15	V_CMP_TRU_F32	D[threadId] = 1. // D = VCC in VOPC encoding.
16	V_CMPX_F_F32	EXEC[threadId] = 0.
17	V_CMPX_LT_F32	EXEC[threadId] = (S0 < S1).
18	V_CMPX_EQ_F32	EXEC[threadId] = (S0 == S1).
19	V_CMPX_LE_F32	EXEC[threadId] = (S0 <= S1).
20	V_CMPX_GT_F32	EXEC[threadId] = (S0 > S1).
21	V_CMPX_LG_F32	EXEC[threadId] = (S0 <> S1).
22	V_CMPX_GE_F32	EXEC[threadId] = (S0 >= S1).
23	V_CMPX_O_F32	EXEC[threadId] = (!isNan(S0) && !isNan(S1)).
24	V_CMPX_U_F32	EXEC[threadId] = (isNan(S0)    isNan(S1)).
25	V_CMPX_NGE_F32	EXEC[threadId] = !(S0 >= S1) // With NAN inputs this is not the same operation as <.
26	V_CMPX_NLG_F32	EXEC[threadId] = !(S0 <> S1) // With NAN inputs this is not the same operation as ==.
27	V_CMPX_NGT_F32	EXEC[threadId] = !(S0 > S1) // With NAN inputs this is not the same operation as <=.

Opcode	Name	Description
28	V_CMPX_NLE_F32	EXEC[threadId] = !(S0 <= S1) // With NAN inputs this is not the same operation as >.
29	V_CMPX_NEQ_F32	EXEC[threadId] = !(S0 == S1) // With NAN inputs this is not the same operation as !=.
30	V_CMPX_NLT_F32	EXEC[threadId] = !(S0 < S1) // With NAN inputs this is not the same operation as >=.
31	V_CMPX_TRU_F32	EXEC[threadId] = 1.
32	V_CMP_F_F64	D[threadId] = 0. // D = VCC in VOPC encoding.
33	V_CMP_LT_F64	D[threadId] = (S0 < S1). // D = VCC in VOPC encoding.
34	V_CMP_EQ_F64	D[threadId] = (S0 == S1). // D = VCC in VOPC encoding.
35	V_CMP_LE_F64	D[threadId] = (S0 <= S1). // D = VCC in VOPC encoding.
36	V_CMP_GT_F64	D[threadId] = (S0 > S1). // D = VCC in VOPC encoding.
37	V_CMP_LG_F64	D[threadId] = (S0 <> S1). // D = VCC in VOPC encoding.
38	V_CMP_GE_F64	D[threadId] = (S0 >= S1). // D = VCC in VOPC encoding.
39	V_CMP_O_F64	D[threadId] = (!isNan(S0) && !isNan(S1)). // D = VCC in VOPC encoding.
40	V_CMP_U_F64	D[threadId] = (isNan(S0)    isNan(S1)). // D = VCC in VOPC encoding.
41	V_CMP_NGE_F64	D[threadId] = !(S0 >= S1) // With NAN inputs this is not the same operation as <. // D = VCC in VOPC encoding.
42	V_CMP_NLG_F64	D[threadId] = !(S0 <> S1) // With NAN inputs this is not the same operation as ==. // D = VCC in VOPC encoding.
43	V_CMP_NGT_F64	D[threadId] = !(S0 > S1) // With NAN inputs this is not the same operation as <=. // D = VCC in VOPC encoding.
44	V_CMP_NLE_F64	D[threadId] = !(S0 <= S1) // With NAN inputs this is not the same operation as >. // D = VCC in VOPC encoding.
45	V_CMP_NEQ_F64	D[threadId] = !(S0 == S1) // With NAN inputs this is not the same operation as !=. // D = VCC in VOPC encoding.
46	V_CMP_NLT_F64	D[threadId] = !(S0 < S1) // With NAN inputs this is not the same operation as >=. // D = VCC in VOPC encoding.
47	V_CMP_TRU_F64	D[threadId] = 1. // D = VCC in VOPC encoding.

Opcode	Name	Description
48	V_CMPX_F_F64	EXEC[threadId] = 0.
49	V_CMPX_LT_F64	EXEC[threadId] = (S0 < S1).
50	V_CMPX_EQ_F64	EXEC[threadId] = (S0 == S1).
51	V_CMPX_LE_F64	EXEC[threadId] = (S0 <= S1).
52	V_CMPX_GT_F64	EXEC[threadId] = (S0 > S1).
53	V_CMPX_LG_F64	EXEC[threadId] = (S0 <> S1).
54	V_CMPX_GE_F64	EXEC[threadId] = (S0 >= S1).
55	V_CMPX_O_F64	EXEC[threadId] = (!isNan(S0) && !isNan(S1)).
56	V_CMPX_U_F64	EXEC[threadId] = (isNan(S0)    isNan(S1)).
57	V_CMPX_NGE_F64	EXEC[threadId] = !(S0 >= S1) // With NAN inputs this is not the same operation as <.
58	V_CMPX_NLG_F64	EXEC[threadId] = !(S0 <> S1) // With NAN inputs this is not the same operation as ==.
59	V_CMPX_NGT_F64	EXEC[threadId] = !(S0 > S1) // With NAN inputs this is not the same operation as <=.
60	V_CMPX_NLE_F64	EXEC[threadId] = !(S0 <= S1) // With NAN inputs this is not the same operation as >.
61	V_CMPX_NEQ_F64	EXEC[threadId] = !(S0 == S1) // With NAN inputs this is not the same operation as !=.
62	V_CMPX_NLT_F64	EXEC[threadId] = !(S0 < S1) // With NAN inputs this is not the same operation as >=.
63	V_CMPX_TRU_F64	EXEC[threadId] = 1.
128	V_CMP_F_I32	D[threadId] = 0. // D = VCC in VOPC encoding.
129	V_CMP_LT_I32	D[threadId] = (S0 < S1). // D = VCC in VOPC encoding.
130	V_CMP_EQ_I32	D[threadId] = (S0 == S1). // D = VCC in VOPC encoding.
131	V_CMP_LE_I32	D[threadId] = (S0 <= S1). // D = VCC in VOPC encoding.
132	V_CMP_GT_I32	D[threadId] = (S0 > S1). // D = VCC in VOPC encoding.
133	V_CMP_NE_I32	D[threadId] = (S0 <> S1). // D = VCC in VOPC encoding.
134	V_CMP_GE_I32	D[threadId] = (S0 >= S1). // D = VCC in VOPC encoding.
135	V_CMP_T_I32	D[threadId] = 1. // D = VCC in VOPC encoding.

Opcode	Name	Description
136	V_CMP_CLASS_F32	<p>VCC = IEEE numeric class function specified in S1.u, performed on S0.f.</p> <p>The function reports true if the floating point value is *any* of the numeric types selected in S1.u according to the following list:</p> <p>S1.u[0] -- value is a signaling NaN.  S1.u[1] -- value is a quiet NaN.  S1.u[2] -- value is negative infinity.  S1.u[3] -- value is a negative normal value.  S1.u[4] -- value is a negative denormal value.  S1.u[5] -- value is negative zero.  S1.u[6] -- value is positive zero.  S1.u[7] -- value is a positive denormal value.  S1.u[8] -- value is a positive normal value.  S1.u[9] -- value is positive infinity.</p>
137	V_CMP_LT_I16	<p>D[threadId] = (S0 &lt; S1).  // D = VCC in VOPC encoding.</p>
138	V_CMP_EQ_I16	<p>D[threadId] = (S0 == S1).  // D = VCC in VOPC encoding.</p>
139	V_CMP_LE_I16	<p>D[threadId] = (S0 &lt;= S1).  // D = VCC in VOPC encoding.</p>
140	V_CMP_GT_I16	<p>D[threadId] = (S0 &gt; S1).  // D = VCC in VOPC encoding.</p>
141	V_CMP_NE_I16	<p>D[threadId] = (S0 &lt;&gt; S1).  // D = VCC in VOPC encoding.</p>
142	V_CMP_GE_I16	<p>D[threadId] = (S0 &gt;= S1).  // D = VCC in VOPC encoding.</p>
143	V_CMP_CLASS_F16	<p>VCC = IEEE numeric class function specified in S1.u, performed on S0.f16.</p> <p>Note that the S1 has a format of f16 since floating point literal constants are interpreted as 16 bit value for this opcode.</p> <p>The function reports true if the floating point value is *any* of the numeric types selected in S1.u according to the following list:</p> <p>S1.u[0] -- value is a signaling NaN.  S1.u[1] -- value is a quiet NaN.  S1.u[2] -- value is negative infinity.  S1.u[3] -- value is a negative normal value.  S1.u[4] -- value is a negative denormal value.  S1.u[5] -- value is negative zero.  S1.u[6] -- value is positive zero.  S1.u[7] -- value is a positive denormal value.  S1.u[8] -- value is a positive normal value.  S1.u[9] -- value is positive infinity.</p>
144	V_CMPX_F_I32	<p>EXEC[threadId] = 0.</p>
145	V_CMPX_LT_I32	<p>EXEC[threadId] = (S0 &lt; S1).</p>
146	V_CMPX_EQ_I32	<p>EXEC[threadId] = (S0 == S1).</p>
147	V_CMPX_LE_I32	<p>EXEC[threadId] = (S0 &lt;= S1).</p>

Opcode	Name	Description
148	V_CMPX_GT_I32	EXEC[threadId] = (S0 > S1).
149	V_CMPX_NE_I32	EXEC[threadId] = (S0 <> S1).
150	V_CMPX_GE_I32	EXEC[threadId] = (S0 >= S1).
151	V_CMPX_T_I32	EXEC[threadId] = 1.
152	V_CMPX_CLASS_F32	<p>EXEC = IEEE numeric class function specified in S1.u, performed on S0.f.</p> <p>The function reports true if the floating point value is <i>any</i> of the numeric types selected in S1.u according to the following list:</p> <p>S1.u[0] -- value is a signaling NaN.  S1.u[1] -- value is a quiet NaN.  S1.u[2] -- value is negative infinity.  S1.u[3] -- value is a negative normal value.  S1.u[4] -- value is a negative denormal value.  S1.u[5] -- value is negative zero.  S1.u[6] -- value is positive zero.  S1.u[7] -- value is a positive denormal value.  S1.u[8] -- value is a positive normal value.  S1.u[9] -- value is positive infinity.</p>
153	V_CMPX_LT_I16	EXEC[threadId] = (S0 < S1).
154	V_CMPX_EQ_I16	EXEC[threadId] = (S0 == S1).
155	V_CMPX_LE_I16	EXEC[threadId] = (S0 <= S1).
156	V_CMPX_GT_I16	EXEC[threadId] = (S0 > S1).
157	V_CMPX_NE_I16	EXEC[threadId] = (S0 <> S1).
158	V_CMPX_GE_I16	EXEC[threadId] = (S0 >= S1).
159	V_CMPX_CLASS_F16	<p>EXEC = IEEE numeric class function specified in S1.u, performed on S0.f16.</p> <p>Note that the S1 has a format of f16 since floating point literal constants are interpreted as 16 bit value for this opcode.</p> <p>The function reports true if the floating point value is <i>any</i> of the numeric types selected in S1.u according to the following list:</p> <p>S1.u[0] -- value is a signaling NaN.  S1.u[1] -- value is a quiet NaN.  S1.u[2] -- value is negative infinity.  S1.u[3] -- value is a negative normal value.  S1.u[4] -- value is a negative denormal value.  S1.u[5] -- value is negative zero.  S1.u[6] -- value is positive zero.  S1.u[7] -- value is a positive denormal value.  S1.u[8] -- value is a positive normal value.  S1.u[9] -- value is positive infinity.</p>
160	V_CMP_F_I64	<p>D[threadId] = 0.  // D = VCC in VOPC encoding.</p>

Opcode	Name	Description
161	V_CMP_LT_I64	D[threadId] = (S0 < S1). // D = VCC in VOPC encoding.
162	V_CMP_EQ_I64	D[threadId] = (S0 == S1). // D = VCC in VOPC encoding.
163	V_CMP_LE_I64	D[threadId] = (S0 <= S1). // D = VCC in VOPC encoding.
164	V_CMP_GT_I64	D[threadId] = (S0 > S1). // D = VCC in VOPC encoding.
165	V_CMP_NE_I64	D[threadId] = (S0 <> S1). // D = VCC in VOPC encoding.
166	V_CMP_GE_I64	D[threadId] = (S0 >= S1). // D = VCC in VOPC encoding.
167	V_CMP_T_I64	D[threadId] = 1. // D = VCC in VOPC encoding.
168	V_CMP_CLASS_F64	VCC = IEEE numeric class function specified in S1.u, performed on S0.d.  The function reports true if the floating point value is *any* of the numeric types selected in S1.u according to the following list:  S1.u[0] -- value is a signaling NaN. S1.u[1] -- value is a quiet NaN. S1.u[2] -- value is negative infinity. S1.u[3] -- value is a negative normal value. S1.u[4] -- value is a negative denormal value. S1.u[5] -- value is negative zero. S1.u[6] -- value is positive zero. S1.u[7] -- value is a positive denormal value. S1.u[8] -- value is a positive normal value. S1.u[9] -- value is positive infinity.
169	V_CMP_LT_U16	D[threadId] = (S0 < S1). // D = VCC in VOPC encoding.
170	V_CMP_EQ_U16	D[threadId] = (S0 == S1). // D = VCC in VOPC encoding.
171	V_CMP_LE_U16	D[threadId] = (S0 <= S1). // D = VCC in VOPC encoding.
172	V_CMP_GT_U16	D[threadId] = (S0 > S1). // D = VCC in VOPC encoding.
173	V_CMP_NE_U16	D[threadId] = (S0 <> S1). // D = VCC in VOPC encoding.
174	V_CMP_GE_U16	D[threadId] = (S0 >= S1). // D = VCC in VOPC encoding.
176	V_CMPX_F_I64	EXEC[threadId] = 0.
177	V_CMPX_LT_I64	EXEC[threadId] = (S0 < S1).
178	V_CMPX_EQ_I64	EXEC[threadId] = (S0 == S1).
179	V_CMPX_LE_I64	EXEC[threadId] = (S0 <= S1).
180	V_CMPX_GT_I64	EXEC[threadId] = (S0 > S1).

Opcode	Name	Description
181	V_CMPX_NE_I64	EXEC[threadId] = (S0 <> S1).
182	V_CMPX_GE_I64	EXEC[threadId] = (S0 >= S1).
183	V_CMPX_T_I64	EXEC[threadId] = 1.
184	V_CMPX_CLASS_F64	<p>EXEC = IEEE numeric class function specified in S1.u, performed on S0.d.</p> <p>The function reports true if the floating point value is <i>any</i> of the numeric types selected in S1.u according to the following list:</p> <p>S1.u[0] -- value is a signaling NaN.  S1.u[1] -- value is a quiet NaN.  S1.u[2] -- value is negative infinity.  S1.u[3] -- value is a negative normal value.  S1.u[4] -- value is a negative denormal value.  S1.u[5] -- value is negative zero.  S1.u[6] -- value is positive zero.  S1.u[7] -- value is a positive denormal value.  S1.u[8] -- value is a positive normal value.  S1.u[9] -- value is positive infinity.</p>
185	V_CMPX_LT_U16	EXEC[threadId] = (S0 < S1).
186	V_CMPX_EQ_U16	EXEC[threadId] = (S0 == S1).
187	V_CMPX_LE_U16	EXEC[threadId] = (S0 <= S1).
188	V_CMPX_GT_U16	EXEC[threadId] = (S0 > S1).
189	V_CMPX_NE_U16	EXEC[threadId] = (S0 <> S1).
190	V_CMPX_GE_U16	EXEC[threadId] = (S0 >= S1).
192	V_CMP_F_U32	D[threadId] = 0. // D = VCC in VOPC encoding.
193	V_CMP_LT_U32	D[threadId] = (S0 < S1). // D = VCC in VOPC encoding.
194	V_CMP_EQ_U32	D[threadId] = (S0 == S1). // D = VCC in VOPC encoding.
195	V_CMP_LE_U32	D[threadId] = (S0 <= S1). // D = VCC in VOPC encoding.
196	V_CMP_GT_U32	D[threadId] = (S0 > S1). // D = VCC in VOPC encoding.
197	V_CMP_NE_U32	D[threadId] = (S0 <> S1). // D = VCC in VOPC encoding.
198	V_CMP_GE_U32	D[threadId] = (S0 >= S1). // D = VCC in VOPC encoding.
199	V_CMP_T_U32	D[threadId] = 1. // D = VCC in VOPC encoding.
200	V_CMP_F_F16	D[threadId] = 0. // D = VCC in VOPC encoding.
201	V_CMP_LT_F16	D[threadId] = (S0 < S1). // D = VCC in VOPC encoding.

Opcode	Name	Description
202	V_CMP_EQ_F16	D[threadId] = (S0 == S1). // D = VCC in VOPC encoding.
203	V_CMP_LE_F16	D[threadId] = (S0 <= S1). // D = VCC in VOPC encoding.
204	V_CMP_GT_F16	D[threadId] = (S0 > S1). // D = VCC in VOPC encoding.
205	V_CMP_LG_F16	D[threadId] = (S0 <> S1). // D = VCC in VOPC encoding.
206	V_CMP_GE_F16	D[threadId] = (S0 >= S1). // D = VCC in VOPC encoding.
207	V_CMP_O_F16	D[threadId] = (!isNan(S0) && !isNan(S1)). // D = VCC in VOPC encoding.
208	V_CMPX_F_U32	EXEC[threadId] = 0.
209	V_CMPX_LT_U32	EXEC[threadId] = (S0 < S1).
210	V_CMPX_EQ_U32	EXEC[threadId] = (S0 == S1).
211	V_CMPX_LE_U32	EXEC[threadId] = (S0 <= S1).
212	V_CMPX_GT_U32	EXEC[threadId] = (S0 > S1).
213	V_CMPX_NE_U32	EXEC[threadId] = (S0 <> S1).
214	V_CMPX_GE_U32	EXEC[threadId] = (S0 >= S1).
215	V_CMPX_T_U32	EXEC[threadId] = 1.
216	V_CMPX_F_F16	EXEC[threadId] = 0.
217	V_CMPX_LT_F16	EXEC[threadId] = (S0 < S1).
218	V_CMPX_EQ_F16	EXEC[threadId] = (S0 == S1).
219	V_CMPX_LE_F16	EXEC[threadId] = (S0 <= S1).
220	V_CMPX_GT_F16	EXEC[threadId] = (S0 > S1).
221	V_CMPX_LG_F16	EXEC[threadId] = (S0 <> S1).
222	V_CMPX_GE_F16	EXEC[threadId] = (S0 >= S1).
223	V_CMPX_O_F16	EXEC[threadId] = (!isNan(S0) && !isNan(S1)).
224	V_CMP_F_U64	D[threadId] = 0. // D = VCC in VOPC encoding.
225	V_CMP_LT_U64	D[threadId] = (S0 < S1). // D = VCC in VOPC encoding.
226	V_CMP_EQ_U64	D[threadId] = (S0 == S1). // D = VCC in VOPC encoding.
227	V_CMP_LE_U64	D[threadId] = (S0 <= S1). // D = VCC in VOPC encoding.
228	V_CMP_GT_U64	D[threadId] = (S0 > S1). // D = VCC in VOPC encoding.
229	V_CMP_NE_U64	D[threadId] = (S0 <> S1). // D = VCC in VOPC encoding.



Opcode	Name	Description
230	V_CMP_GE_U64	D[threadId] = (S0 >= S1). // D = VCC in VOPC encoding.
231	V_CMP_T_U64	D[threadId] = 1. // D = VCC in VOPC encoding.
232	V_CMP_U_F16	D[threadId] = (isNaN(S0)    isNaN(S1)). // D = VCC in VOPC encoding.
233	V_CMP_NGE_F16	D[threadId] = !(S0 >= S1) // With NAN inputs this is not the same operation as <. // D = VCC in VOPC encoding.
234	V_CMP_NLG_F16	D[threadId] = !(S0 <> S1) // With NAN inputs this is not the same operation as ==. // D = VCC in VOPC encoding.
235	V_CMP_NGT_F16	D[threadId] = !(S0 > S1) // With NAN inputs this is not the same operation as <=. // D = VCC in VOPC encoding.
236	V_CMP_NLE_F16	D[threadId] = !(S0 <= S1) // With NAN inputs this is not the same operation as >. // D = VCC in VOPC encoding.
237	V_CMP_NEQ_F16	D[threadId] = !(S0 == S1) // With NAN inputs this is not the same operation as !=. // D = VCC in VOPC encoding.
238	V_CMP_NLT_F16	D[threadId] = !(S0 < S1) // With NAN inputs this is not the same operation as >=. // D = VCC in VOPC encoding.
239	V_CMP_TRU_F16	D[threadId] = 1. // D = VCC in VOPC encoding.
240	V_CMPX_F_U64	EXEC[threadId] = 0.
241	V_CMPX_LT_U64	EXEC[threadId] = (S0 < S1).
242	V_CMPX_EQ_U64	EXEC[threadId] = (S0 == S1).
243	V_CMPX_LE_U64	EXEC[threadId] = (S0 <= S1).
244	V_CMPX_GT_U64	EXEC[threadId] = (S0 > S1).
245	V_CMPX_NE_U64	EXEC[threadId] = (S0 <> S1).
246	V_CMPX_GE_U64	EXEC[threadId] = (S0 >= S1).
247	V_CMPX_T_U64	EXEC[threadId] = 1.
248	V_CMPX_U_F16	EXEC[threadId] = (isNaN(S0)    isNaN(S1)).
249	V_CMPX_NGE_F16	EXEC[threadId] = !(S0 >= S1) // With NAN inputs this is not the same operation as <.
250	V_CMPX_NLG_F16	EXEC[threadId] = !(S0 <> S1) // With NAN inputs this is not the same operation as ==.
251	V_CMPX_NGT_F16	EXEC[threadId] = !(S0 > S1) // With NAN inputs this is not the same operation as <=.
252	V_CMPX_NLE_F16	EXEC[threadId] = !(S0 <= S1) // With NAN inputs this is not the same operation as >.

Opcode	Name	Description
253	V_CMPX_NEQ_F16	EXEC[threadId] = !(S0 == S1) // With NAN inputs this is not the same operation as !=.
254	V_CMPX_NLT_F16	EXEC[threadId] = !(S0 < S1) // With NAN inputs this is not the same operation as >=.
255	V_CMPX_TRU_F16	EXEC[threadId] = 1.

### 12.9.1. VOPC using VOP3A encoding

Instructions in this format may also be encoded as VOP3A. VOP3A allows access to the extra control bits (e.g. ABS, OMOD) at the expense of a larger instruction word. The VOP3A opcode is: VOP2 opcode + 0x000.

When the CLAMP microcode bit is set to 1, these compare instructions signal an exception when either of the inputs is NaN. When CLAMP is set to zero, NaN does not signal an exception. The second eight VOPC instructions have {OP8} embedded in them. This refers to each of the compare operations listed below.

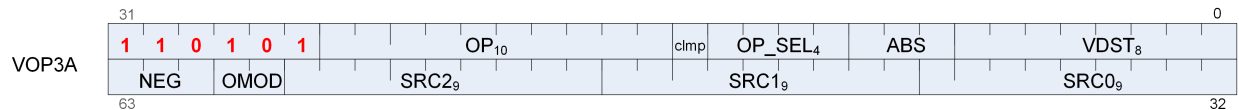

where:

- VDST = Destination for instruction in the VGPR.
- ABS = Floating-point absolute value.
- CLMP = Clamp output.
- OP = Instruction opcode.
- SRC0 = First operand for instruction.
- SRC1 = Second operand for instruction.
- SRC2 = Third operand for instruction. Unused in VOPC instructions.
- OMOD = Output modifier for instruction. Unused in VOPC instructions.
- NEG = Floating-point negation.

## 12.10. VOP3P Instructions

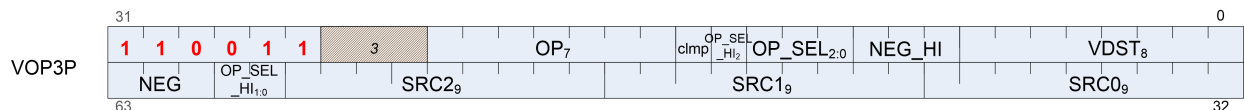

Opcode	Name	Description
0	V_PK_MAD_I16	Packed multiply-add on signed shorts.  $D.i[31:16] = S0.i[31:16] * S1.i[31:16] + S2.i[31:16];$ $D.i[15:0] = S0.i[15:0] * S1.i[15:0] + S2.i[15:0].$

Opcode	Name	Description
1	V_PK_MUL_LO_U16	Packed multiply on unsigned shorts.  $D.u[31:16] = S0.u[31:16] * S1.u[31:16];$ $D.u[15:0] = S0.u[15:0] * S1.u[15:0].$
2	V_PK_ADD_I16	Packed addition on signed shorts.  $D.i[31:16] = S0.i[31:16] + S1.i[31:16];$ $D.i[15:0] = S0.i[15:0] + S1.i[15:0].$
3	V_PK_SUB_I16	Packed subtraction on signed shorts. The second operand is subtracted from the first.  $D.i[31:16] = S0.i[31:16] - S1.i[31:16];$ $D.i[15:0] = S0.i[15:0] - S1.i[15:0].$
4	V_PK_LSHLREV_B16	Packed logical shift left. The shift count is in the first operand.  $D.u[31:16] = S1.u[31:16] \ll S0.u[19:16];$ $D.u[15:0] = S1.u[15:0] \ll S0.u[3:0].$
5	V_PK_LSHRREV_B16	Packed logical shift right. The shift count is in the first operand.  $D.u[31:16] = S1.u[31:16] \gg S0.u[19:16];$ $D.u[15:0] = S1.u[15:0] \gg S0.u[3:0].$
6	V_PK_ASHRREV_I16	Packed arithmetic shift right (preserve sign bit). The shift count is in the first operand.  $D.i[31:16] = S1.i[31:16] \ggg S0.i[19:16];$ $D.i[15:0] = S1.i[15:0] \ggg S0.i[3:0].$
7	V_PK_MAX_I16	Packed maximum of signed shorts.  $D.i[31:16] = (S0.i[31:16] \geq S1.i[31:16]) ? S0.i[31:16] : S1.i[31:16];$ $D.i[15:0] = (S0.i[15:0] \geq S1.i[15:0]) ? S0.i[15:0] : S1.i[15:0].$
8	V_PK_MIN_I16	Packed minimum of signed shorts.  $D.i[31:16] = (S0.i[31:16] < S1.i[31:16]) ? S0.i[31:16] : S1.i[31:16];$ $D.i[15:0] = (S0.i[15:0] < S1.i[15:0]) ? S0.i[15:0] : S1.i[15:0].$
9	V_PK_MAD_U16	Packed multiply-add on unsigned shorts.  $D.u[31:16] = S0.u[31:16] * S1.u[31:16] + S2.u[31:16];$ $D.u[15:0] = S0.u[15:0] * S1.u[15:0] + S2.u[15:0].$
10	V_PK_ADD_U16	Packed addition on unsigned shorts.  $D.u[31:16] = S0.u[31:16] + S1.u[31:16];$ $D.u[15:0] = S0.u[15:0] + S1.u[15:0].$

Opcode	Name	Description
11	V_PK_SUB_U16	Packed subtraction on unsigned shorts. The second operand is subtracted from the first.  $D.u[31:16] = S0.u[31:16] - S1.u[31:16];$ $D.u[15:0] = S0.u[15:0] - S1.u[15:0].$
12	V_PK_MAX_U16	Packed maximum of unsigned shorts.  $D.u[31:16] = (S0.u[31:16] \geq S1.u[31:16]) ? S0.u[31:16] : S1.u[31:16];$ $D.u[15:0] = (S0.u[15:0] \geq S1.u[15:0]) ? S0.u[15:0] : S1.u[15:0].$
13	V_PK_MIN_U16	Packed minimum of unsigned shorts.  $D.u[31:16] = (S0.u[31:16] < S1.u[31:16]) ? S0.u[31:16] : S1.u[31:16];$ $D.u[15:0] = (S0.u[15:0] < S1.u[15:0]) ? S0.u[15:0] : S1.u[15:0].$
14	V_PK_FMA_F16	Packed fused-multiply-add of FP16 values.  $D.f[31:16] = S0.f[31:16] * S1.f[31:16] + S2.f[31:16];$ $D.f[15:0] = S0.f[15:0] * S1.f[15:0] + S2.f[15:0].$
15	V_PK_ADD_F16	Packed addition of FP16 values.  $D.f[31:16] = S0.f[31:16] + S1.f[31:16];$ $D.f[15:0] = S0.f[15:0] + S1.f[15:0].$
16	V_PK_MUL_F16	Packed multiply of FP16 values.  $D.f[31:16] = S0.f[31:16] * S1.f[31:16];$ $D.f[15:0] = S0.f[15:0] * S1.f[15:0].$
17	V_PK_MIN_F16	Packed minimum of FP16 values.  $D.f[31:16] = \min(S0.f[31:16], S1.f[31:16]);$ $D.f[15:0] = \min(S0.f[15:0], S1.f[15:0]).$
18	V_PK_MAX_F16	Packed maximum of FP16 values.  $D.f[31:16] = \max(S0.f[31:16], S1.f[31:16]);$ $D.f[15:0] = \max(S0.f[15:0], S1.f[15:0]).$
19	V_DOT2_F32_F16	Dot product of packed FP16 values.  $D.f32 =$ $S0.f16[0] * S1.f16[0] +$ $S0.f16[1] * S1.f16[1] + S2.f32.$
20	V_DOT2_I32_I16	Dot product of signed shorts.  $D.i32 =$ $S0.i16[0] * S1.i16[0] +$ $S0.i16[1] * S1.i16[1] + S2.i32.$
21	V_DOT2_U32_U16	Dot product of unsigned shorts.  $D.u32 =$ $S0.u16[0] * S1.u16[0] +$ $S0.u16[1] * S1.u16[1] + S2.u32.$

Opcode	Name	Description
22	V_DOT4_I32_I8	Dot product of signed bytes.  $D.i32 =$ $S0.i8[0] * S1.i8[0] +$ $S0.i8[1] * S1.i8[1] +$ $S0.i8[2] * S1.i8[2] +$ $S0.i8[3] * S1.i8[3] + S2.i32.$
23	V_DOT4_U32_U8	Dot product of unsigned bytes.  $D.u32 =$ $S0.u8[0] * S1.u8[0] +$ $S0.u8[1] * S1.u8[1] +$ $S0.u8[2] * S1.u8[2] +$ $S0.u8[3] * S1.u8[3] + S2.u32.$
24	V_DOT8_I32_I4	Dot product of signed nibbles.  $D.i32 =$ $S0.i4[0] * S1.i4[0] +$ $S0.i4[1] * S1.i4[1] +$ $S0.i4[2] * S1.i4[2] +$ $S0.i4[3] * S1.i4[3] +$ $S0.i4[4] * S1.i4[4] +$ $S0.i4[5] * S1.i4[5] +$ $S0.i4[6] * S1.i4[6] +$ $S0.i4[7] * S1.i4[7] + S2.i32.$
25	V_DOT8_U32_U4	Dot product of unsigned nibbles.  $D.u32 =$ $S0.u4[0] * S1.u4[0] +$ $S0.u4[1] * S1.u4[1] +$ $S0.u4[2] * S1.u4[2] +$ $S0.u4[3] * S1.u4[3] +$ $S0.u4[4] * S1.u4[4] +$ $S0.u4[5] * S1.u4[5] +$ $S0.u4[6] * S1.u4[6] +$ $S0.u4[7] * S1.u4[7] + S2.u32.$
32	V_FMA_MIX_F32	Fused-multiply-add of single-precision values with MIX encoding. Size and location of S0, S1 and S2 controlled by OPSEL: 0=src[31:0], 1=src[31:0], 2=src[15:0], 3=src[31:16]. Also, for MAD_MIX, the NEG_HI field acts instead as an absolute-value modifier.  $D.f[31:0] = S0.f * S1.f + S2.f.$
33	V_FMA_MIXLO_F16	Fused-multiply-add of FP16 values with MIX encoding, result stored in low 16 bits of destination. Size and location of S0, S1 and S2 controlled by OPSEL: 0=src[31:0], 1=src[31:0], 2=src[15:0], 3=src[31:16]. Also, for MAD_MIX, the NEG_HI field acts instead as an absolute-value modifier.  $D.f[15:0] = S0.f * S1.f + S2.f.$

Opcode	Name	Description
34	V_FMA_MIXHI_F16	Fused-multiply-add of FP16 values with MIX encoding, result stored in HIGH 16 bits of destination. Size and location of S0, S1 and S2 controlled by OPSEL: 0=src[31:0], 1=src[31:0], 2=src[15:0], 3=src[31:16]. Also, for MAD_MIX, the NEG_HI field acts instead as an absolute-value modifier.  $D.f[31:16] = S0.f * S1.f + S2.f.$

## 12.11. VINTERP Instructions



Opcode	Name	Description
0	V_INTERP_P1_F32	Parameter interpolation, first pass.  $D.f32 = P10[S1.u32].f32 * S0.f32 + P0[S1.u3].f32.$  CAUTION: when in HALF_LDS mode, D must not be the same GPR as S; if D == S then data corruption will occur.  NOTE: In textual representations the I/J VGPR is the first source and the attribute is the second source; however in the VOP3 encoding the attribute is stored in the src0 field and the VGPR is stored in the src1 field.
1	V_INTERP_P2_F32	Parameter interpolation, second pass.  $D.f = P20[S1.u] * S0.f + D.f.$  NOTE: In textual representations the I/J VGPR is the first source and the attribute is the second source; however in the VOP3 encoding the attribute is stored in the src0 field and the VGPR is stored in the src1 field.
2	V_INTERP_MOV_F32	Parameter load. Used for custom interpolation in the shader.  $D.f = \{P10, P20, P0\}[S1.u].$

### 12.11.1. VINTERP using VOP3 encoding

Instructions in this format may also be encoded as VOP3A. VOP3A allows access to the extra control bits (e.g. ABS, OMOD) at the expense of a larger instruction word. The VOP3A opcode is: VOP2 opcode + 0x270.

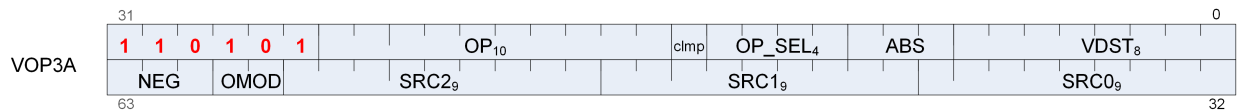

## 12.12. VOP3A & VOP3B Instructions

VOP3 instructions use one of two encodings:

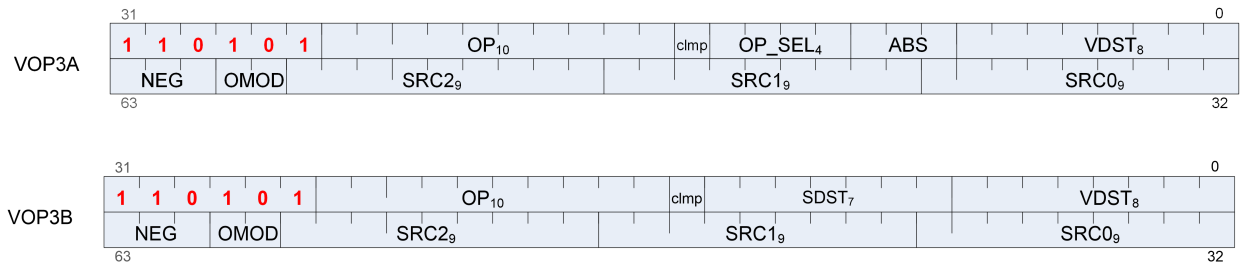

**VOP3B** this encoding allows specifying a unique scalar destination, and is used only for:

- V\_ADD\_CO\_U32
- V\_SUB\_CO\_U32
- V\_SUBREV\_CO\_U32
- V\_ADDDC\_CO\_U32
- V\_SUBB\_CO\_U32
- V\_SUBBREV\_CO\_U32
- V\_DIV\_SCALE\_F32
- V\_DIV\_SCALE\_F64
- V\_MAD\_U64\_U32
- V\_MAD\_I64\_I32

**VOP3A** all other VALU instructions use this encoding

Opcode	Name	Description
320	V_FMA_LEGACY_F32	Multiply and add single-precision values. Follows DX9 rules where 0.0 times anything produces 0.0 (this is not IEEE compliant).  $D.f = S0.f * S1.f + S2.f.$ // DX9 rules, $0.0 * x = 0.0$
322	V_MAD_I32_I24	Multiply two signed 24-bit integers, add a signed 32-bit integer and store the result as a signed 32-bit integer. This opcode is as efficient as basic single-precision opcodes since it utilizes the single-precision floating point multiplier.  $D.i = S0.i[23:0] * S1.i[23:0] + S2.i.$
323	V_MAD_U32_U24	Multiply two unsigned 24-bit integers, add an unsigned 32-bit integer and store the result as an unsigned 32-bit integer. This opcode is as efficient as basic single-precision opcodes since it utilizes the single-precision floating point multiplier.  $D.u = S0.u[23:0] * S1.u[23:0] + S2.u.$

Opcode	Name	Description
324	V_CUBEID_F32	<p>Cubemap Face ID determination. Result is a floating point face ID.</p> <pre> // Set D.f = cubemap face ID ({0.0, 1.0, ..., 5.0}). // XYZ coordinate is given in (S0.f, S1.f, S2.f). // S0.f = x // S1.f = y // S2.f = z if (abs(S2.f) &gt;= abs(S0.f) &amp;&amp; abs(S2.f) &gt;= abs(S1.f))   if (S2.f &lt; 0)     D.f = 5.0;   else     D.f = 4.0;   endif; else if (abs(S1.f) &gt;= abs(S0.f))   if (S1.f &lt; 0)     D.f = 3.0;   else     D.f = 2.0;   endif; else   if (S0.f &lt; 0)     D.f = 1.0;   else     D.f = 0.0;   endif; endif. </pre>
325	V_CUBESC_F32	<p>Cubemap S coordinate.</p> <pre> // D.f = cubemap S coordinate. // XYZ coordinate is given in (S0.f, S1.f, S2.f). // S0.f = x // S1.f = y // S2.f = z if (abs(S2.f) &gt;= abs(S0.f) &amp;&amp; abs(S2.f) &gt;= abs(S1.f))   if (S2.f &lt; 0)     D.f = -S0.f;   else     D.f = S0.f;   endif; else if (abs(S1.f) &gt;= abs(S0.f))   D.f = S0.f; else   if (S0.f &lt; 0)     D.f = S2.f;   else     D.f = -S2.f;   endif; endif. </pre>



Opcode	Name	Description
326	V_CUBETC_F32	<p>Cubemap T coordinate.</p> <pre> // D.f = cubemap T coordinate. // XYZ coordinate is given in (S0.f, S1.f, S2.f). // S0.f = x // S1.f = y // S2.f = z if (abs(S2.f) &gt;= abs(S0.f) &amp;&amp; abs(S2.f) &gt;= bs(S1.f))     D.f = -S1.f; else if (abs(S1.f) &gt;= abs(S0.f))     if (S1.f &lt; 0)         D.f = -S2.f;     else         D.f = S2.f; endif; else     D.f = -S1.f; endif.</pre>
327	V_CUBEMA_F32	<p>Determine cubemap major axis.</p> <pre> // D.f = 2.0 * cubemap major axis. // XYZ coordinate is given in (S0.f, S1.f, S2.f). // S0.f = x // S1.f = y // S2.f = z if (abs(S2.f) &gt;= abs(S0.f) &amp;&amp; abs(S2.f) &gt;= abs(S1.f))     D.f = 2.0 * S2.f; else if (abs(S1.f) &gt;= abs(S0.f))     D.f = 2.0 * S1.f; else     D.f = 2.0 * S0.f; endif.</pre>
328	V_BFE_U32	<p>Bitfield extract with S0 = data, S1 = field_offset, S2 = field_width.</p> <pre> D.u = (S0.u &gt;&gt; S1.u[4:0]) &amp; ((1 &lt;&lt; S2.u[4:0]) - 1).</pre>
329	V_BFE_I32	<p>Bitfield extract with S0 = data, S1 = field_offset, S2 = field_width.</p> <pre> D.i = (S0.i &gt;&gt; S1.u[4:0]) &amp; ((1 &lt;&lt; S2.u[4:0]) - 1).</pre>
330	V_BFI_B32	<p>Bitfield insert.</p> <pre> D.u = (S0.u &amp; S1.u)   (~S0.u &amp; S2.u).</pre>
331	V_FMA_F32	<p>Fused single precision multiply add. 0.5ULP accuracy, denormals are supported.</p> <pre> D.f = S0.f * S1.f + S2.f.</pre>
332	V_FMA_F64	<p>Fused double precision multiply add. 0.5ULP precision, denormals are supported.</p> <pre> D.d = S0.d * S1.d + S2.d.</pre>

Opcode	Name	Description
333	V_LERP_U8	Unsigned 8-bit pixel average on packed unsigned bytes (linear interpolation). S2 acts as a round mode; if set, 0.5 rounds up, otherwise 0.5 truncates.  $D.u = ((S0.u[31:24] + S1.u[31:24] + S2.u[24]) >> 1) << 24$ $D.u += ((S0.u[23:16] + S1.u[23:16] + S2.u[16]) >> 1) << 16;$ $D.u += ((S0.u[15:8] + S1.u[15:8] + S2.u[8]) >> 1) << 8;$ $D.u += ((S0.u[7:0] + S1.u[7:0] + S2.u[0]) >> 1).$
334	V_ALIGNBIT_B32	Align a value to the specified bit position.  $D.u = (\{S0, S1\} >> S2.u[4:0]) \& 0xffffffff.$
335	V_ALIGNBYTE_B32	Align a value to the specified byte position.  $D.u = (\{S0, S1\} >> (8 * S2.u[4:0])) \& 0xffffffff.$
336	V_MULLIT_F32	Multiply for lighting. Specific rules apply: $0.0 * x = 0.0$ ; Specific INF, NaN, overflow rules.  $D.f = S0.f * S1.f$
337	V_MIN3_F32	Return minimum single-precision value of three inputs.  $D.f = V\_MIN\_F32(V\_MIN\_F32(S0.f, S1.f), S2.f).$
338	V_MIN3_I32	Return minimum signed integer value of three inputs.  $D.i = V\_MIN\_I32(V\_MIN\_I32(S0.i, S1.i), S2.i).$
339	V_MIN3_U32	Return minimum unsigned integer value of three inputs.  $D.u = V\_MIN\_U32(V\_MIN\_U32(S0.u, S1.u), S2.u).$
340	V_MAX3_F32	Return maximum single precision value of three inputs.  $D.f = V\_MAX\_F32(V\_MAX\_F32(S0.f, S1.f), S2.f).$
341	V_MAX3_I32	Return maximum signed integer value of three inputs.  $D.i = V\_MAX\_I32(V\_MAX\_I32(S0.i, S1.i), S2.i).$
342	V_MAX3_U32	Return maximum unsigned integer value of three inputs.  $D.u = V\_MAX\_U32(V\_MAX\_U32(S0.u, S1.u), S2.u).$
343	V_MED3_F32	Return median single precision value of three inputs.  <pre> if (isNan(S0.f)    isNan(S1.f)    isNan(S2.f))     D.f = V_MIN3_F32(S0.f, S1.f, S2.f); else if (V_MAX3_F32(S0.f, S1.f, S2.f) == S0.f)     D.f = V_MAX_F32(S1.f, S2.f); else if (V_MAX3_F32(S0.f, S1.f, S2.f) == S1.f)     D.f = V_MAX_F32(S0.f, S2.f); else     D.f = V_MAX_F32(S0.f, S1.f); endif. </pre>

Opcode	Name	Description
344	V_MED3_I32	<p>Return median signed integer value of three inputs.</p> <pre> if (V_MAX3_I32(S0.i, S1.i, S2.i) == S0.i)     D.i = V_MAX_I32(S1.i, S2.i); else if (V_MAX3_I32(S0.i, S1.i, S2.i) == S1.i)     D.i = V_MAX_I32(S0.i, S2.i); else     D.i = V_MAX_I32(S0.i, S1.i); endif.</pre>
345	V_MED3_U32	<p>Return median unsigned integer value of three inputs.</p> <pre> if (V_MAX3_U32(S0.u, S1.u, S2.u) == S0.u)     D.u = V_MAX_U32(S1.u, S2.u); else if (V_MAX3_U32(S0.u, S1.u, S2.u) == S1.u)     D.u = V_MAX_U32(S0.u, S2.u); else     D.u = V_MAX_U32(S0.u, S1.u); endif.</pre>
346	V_SAD_U8	<p>Sum of absolute differences with accumulation, overflow into upper bits is allowed.</p> <pre> ABSDIFF(x, y) := (x &gt; y ? x - y : y - x) // UNSIGNED comparison D.u = S2.u; D.u += ABSDIFF(S0.u[31:24], S1.u[31:24]); D.u += ABSDIFF(S0.u[23:16], S1.u[23:16]); D.u += ABSDIFF(S0.u[15:8], S1.u[15:8]); D.u += ABSDIFF(S0.u[7:0], S1.u[7:0]).</pre>
347	V_SAD_HI_U8	<p>Sum of absolute differences with accumulation, accumulate into the higher-order bits of S2.</p> <pre> D.u = (V_SAD_U8(S0, S1, 0) &lt;&lt; 16) + S2.u.</pre>
348	V_SAD_U16	<p>Short SAD with accumulation.</p> <pre> ABSDIFF(x, y) := (x &gt; y ? x - y : y - x) // UNSIGNED comparison D.u = S2.u; D.u += ABSDIFF(S0.u[31:16], S1.u[31:16]); D.u += ABSDIFF(S0.u[15:0], S1.u[15:0]).</pre>
349	V_SAD_U32	<p>Dword SAD with accumulation.</p> <pre> ABSDIFF(x, y) := (x &gt; y ? x - y : y - x) // UNSIGNED comparison D.u = ABSDIFF(S0.u, S1.u) + S2.u.</pre>
350	V_CVT_PK_U8_F32	<p>Convert floating point value S0 to 8-bit unsigned integer and pack the result into byte S1 of dword S2.</p> <pre> D.u = (S2.u &amp; ~(0xff &lt;&lt; (8 * S1.u[1:0]))); D.u = D.u   ((flt32_to_uint8(S0.f) &amp; 0xff) &lt;&lt; (8 * S1.u[1:0])).</pre>

Opcode	Name	Description
351	V_DIV_FIXUP_F32	<p>Single precision division fixup. S0 = Quotient, S1 = Denominator, S2 = Numerator.</p> <p>Given a numerator, denominator, and quotient from a divide, this opcode will detect and apply specific case numerics, touching up the quotient if necessary. This opcode also generates invalid, denorm and divide by zero exceptions caused by the division.</p> <pre> sign_out = sign(S1.f)^sign(S2.f); if (S2.f == NAN)     D.f = Quiet(S2.f); else if (S1.f == NAN)     D.f = Quiet(S1.f); else if (S1.f == S2.f == 0)     // 0/0     D.f = 0xffc0_0000; else if (abs(S1.f) == abs(S2.f) == +-INF)     // inf/inf     D.f = 0xffc0_0000; else if (S1.f == 0    abs(S2.f) == +-INF)     // x/0, or inf/y     D.f = sign_out ? -INF : +INF; else if (abs(S1.f) == +-INF    S2.f == 0)     // x/inf, 0/y     D.f = sign_out ? -0 : 0; else if ((exponent(S2.f) - exponent(S1.f)) &lt; -150)     D.f = sign_out ? -underflow : underflow; else if (exponent(S1.f) == 255)     D.f = sign_out ? -overflow : overflow; else     D.f = sign_out ? -abs(S0.f) : abs(S0.f); endif. </pre>

Opcode	Name	Description
352	V_DIV_FIXUP_F64	<p>Double precision division fixup. S0 = Quotient, S1 = Denominator, S2 = Numerator.</p> <p>Given a numerator, denominator, and quotient from a divide, this opcode will detect and apply specific case numerics, touching up the quotient if necessary. This opcode also generates invalid, denorm and divide by zero exceptions caused by the division.</p> <pre> sign_out = sign(S1.d)^sign(S2.d); if (S2.d == NAN)     D.d = Quiet(S2.d); else if (S1.d == NAN)     D.d = Quiet(S1.d); else if (S1.d == S2.d == 0)     // 0/0     D.d = 0xfff8_0000_0000_0000; else if (abs(S1.d) == abs(S2.d) == +-INF)     // inf/inf     D.d = 0xfff8_0000_0000_0000; else if (S1.d == 0    abs(S2.d) == +-INF)     // x/0, or inf/y     D.d = sign_out ? -INF : +INF; else if (abs(S1.d) == +-INF    S2.d == 0)     // x/inf, 0/y     D.d = sign_out ? -0 : 0; else if ((exponent(S2.d) - exponent(S1.d)) &lt; -1075)     D.d = sign_out ? -underflow : underflow; else if (exponent(S1.d) == 2047)     D.d = sign_out ? -overflow : overflow; else     D.d = sign_out ? -abs(S0.d) : abs(S0.d); endif. </pre>
356	V_ADD_F64	<p>Add two double-precision values. 0.5ULP precision, denormals are supported.</p> <pre> D.d = S0.d + S1.d. </pre>
357	V_MUL_F64	<p>Multiply two double-precision values. 0.5ULP precision, denormals are supported.</p> <pre> D.d = S0.d * S1.d. </pre>

Opcode	Name	Description
358	V_MIN_F64	<p>Compute the minimum of two double-precision floats.</p> <pre> if (IEEE_MODE &amp;&amp; S0.d == sNaN)     D.d = Quiet(S0.d); else if (IEEE_MODE &amp;&amp; S1.d == sNaN)     D.d = Quiet(S1.d); else if (S0.d == NaN)     D.d = S1.d; else if (S1.d == NaN)     D.d = S0.d; else if (S0.d == +0.0 &amp;&amp; S1.d == -0.0)     D.d = S1.d; else if (S0.d == -0.0 &amp;&amp; S1.d == +0.0)     D.d = S0.d; else     // Note: there's no IEEE special case here like there is for     V_MAX_F64.     D.d = (S0.d &lt; S1.d ? S0.d : S1.d); endif. </pre>
359	V_MAX_F64	<p>Compute the maximum of two double-precision floats.</p> <pre> if (IEEE_MODE &amp;&amp; S0.d == sNaN)     D.d = Quiet(S0.d); else if (IEEE_MODE &amp;&amp; S1.d == sNaN)     D.d = Quiet(S1.d); else if (S0.d == NaN)     D.d = S1.d; else if (S1.d == NaN)     D.d = S0.d; else if (S0.d == +0.0 &amp;&amp; S1.d == -0.0)     D.d = S0.d; else if (S0.d == -0.0 &amp;&amp; S1.d == +0.0)     D.d = S1.d; else if (IEEE_MODE)     D.d = (S0.d &gt;= S1.d ? S0.d : S1.d); else     D.d = (S0.d &gt; S1.d ? S0.d : S1.d); endif. </pre>
360	V_LDEXP_F64	<p>Multiply a double-precision float by an integral power of 2, compare with the ldexp() function in C.</p> <pre> D.d = S0.d * (2 ** S1.i). </pre>
361	V_MUL_LO_U32	<p>Multiply two unsigned integers. If you only need to multiply integers with small magnitudes consider V_MUL_U32_U24, which is a faster implementation.</p> <pre> D.u = S0.u * S1.u. </pre>
362	V_MUL_HI_U32	<p>Multiply two unsigned integers and store the high 32 bits of the result. If you only need to multiply integers with small magnitudes consider V_MUL_HI_U32_U24, which is a faster implementation.</p> <pre> D.u = (S0.u * S1.u) &gt;&gt; 32. </pre>

Opcode	Name	Description
364	V_MUL_HI_I32	<p>Multiply two signed integers and store the high 32 bits of the result. If you only need to multiply integers with small magnitudes consider V_MUL_HI_I32_I24, which is a faster implementation.</p> $D.i = (S0.i * S1.i) \gg 32.$
365	V_DIV_SCALE_F32	<p>Single precision division pre-scale. S0 = Input to scale (either denominator or numerator), S1 = Denominator, S2 = Numerator.</p> <p>Given a numerator and denominator, this opcode will appropriately scale inputs for division to avoid subnormal terms during Newton-Raphson correction algorithm. S0 must be the same value as either S1 or S2.</p> <p>This opcode produces a VCC flag for post-scaling of the quotient (using V_DIV_FMAS_F32).</p> <pre> VCC = 0; if (S2.f == 0    S1.f == 0)     D.f = NAN else if (exponent(S2.f) - exponent(S1.f) &gt;= 96)     // N/D near MAX_FLOAT     VCC = 1;     if (S0.f == S1.f)         // Only scale the denominator         D.f = ldexp(S0.f, 64);     end if else if (S1.f == DENORM)     D.f = ldexp(S0.f, 64); else if (1 / S1.f == DENORM &amp;&amp; S2.f / S1.f == DENORM)     VCC = 1;     if (S0.f == S1.f)         // Only scale the denominator         D.f = ldexp(S0.f, 64);     end if else if (1 / S1.f == DENORM)     D.f = ldexp(S0.f, -64); else if (S2.f / S1.f == DENORM)     VCC = 1;     if (S0.f == S2.f)         // Only scale the numerator         D.f = ldexp(S0.f, 64);     end if else if (exponent(S2.f) &lt;= 23)     // Numerator is tiny     D.f = ldexp(S0.f, 64); end if. </pre>

Opcode	Name	Description
366	V_DIV_SCALE_F64	<p>Double precision division pre-scale. S0 = Input to scale (either denominator or numerator), S1 = Denominator, S2 = Numerator.</p> <p>Given a numerator and denominator, this opcode will appropriately scale inputs for division to avoid subnormal terms during Newton-Raphson correction algorithm. S0 must be the same value as either S1 or S2.</p> <p>This opcode produces a VCC flag for post-scaling of the quotient (using V_DIV_FMAS_F64).</p> <pre> VCC = 0; if (S2.d == 0    S1.d == 0)     D.d = NAN else if (exponent(S2.d) - exponent(S1.d) &gt;= 768)     // N/D near MAX_FLOAT     VCC = 1;     if (S0.d == S1.d)         // Only scale the denominator         D.d = ldexp(S0.d, 128);     end if else if (S1.d == DENORM)     D.d = ldexp(S0.d, 128); else if (1 / S1.d == DENORM &amp;&amp; S2.d / S1.d == DENORM)     VCC = 1;     if (S0.d == S1.d)         // Only scale the denominator         D.d = ldexp(S0.d, 128);     end if else if (1 / S1.d == DENORM)     D.d = ldexp(S0.d, -128); else if (S2.d / S1.d == DENORM)     VCC = 1;     if (S0.d == S2.d)         // Only scale the numerator         D.d = ldexp(S0.d, 128);     end if else if (exponent(S2.d) &lt;= 53)     // Numerator is tiny     D.d = ldexp(S0.d, 128); end if. </pre>
367	V_DIV_FMAS_F32	<p>Single precision FMA with fused scale.</p> <p>This opcode performs a standard Fused Multiply-Add operation and will conditionally scale the resulting exponent if VCC is set.</p> <p>Input denormals are not flushed, but output flushing is allowed.</p> <pre> if (VCC[threadId])     D.f = 2**32 * (S0.f * S1.f + S2.f); else     D.f = S0.f * S1.f + S2.f; end if. </pre>



Opcode	Name	Description
368	V_DIV_FMAS_F64	<p>Double precision FMA with fused scale.</p> <p>This opcode performs a standard Fused Multiply-Add operation and will conditionally scale the resulting exponent if VCC is set.</p> <p>Input denormals are not flushed, but output flushing is allowed.</p> <pre> if (VCC[threadId])     D.d = 2**64 * (S0.d * S1.d + S2.d); else     D.d = S0.d * S1.d + S2.d; end if.</pre>
369	V_MSAD_U8	<p>Masked sum of absolute differences with accumulation, overflow into upper bits is allowed. Components where the reference value in S1 is zero are not included in the sum.</p> <pre> ABSDIFF(x, y) := (x &gt; y ? x - y : y - x) // UNSIGNED comparison D.u = S2.u; D.u += S1.u[31:24] == 0 ? 0 : ABSDIFF(S0.u[31:24], S1.u[31:24]); D.u += S1.u[23:16] == 0 ? 0 : ABSDIFF(S0.u[23:16], S1.u[23:16]); D.u += S1.u[15:8] == 0 ? 0 : ABSDIFF(S0.u[15:8], S1.u[15:8]); D.u += S1.u[7:0] == 0 ? 0 : ABSDIFF(S0.u[7:0], S1.u[7:0]).</pre>
370	V_QSAD_PK_U16_U8	<p>Quad-byte SAD with 16-bit packed accumulation.</p> <pre> D[63:48] = SAD_U8(S0[55:24], S1[31:0], S2[63:48]); D[47:32] = SAD_U8(S0[47:16], S1[31:0], S2[47:32]); D[31:16] = SAD_U8(S0[39:8], S1[31:0], S2[31:16]); D[15:0] = SAD_U8(S0[31:0], S1[31:0], S2[15:0]).</pre>
371	V_MQSAD_PK_U16_U8	<p>Quad-byte masked SAD with 16-bit packed accumulation.</p> <pre> D[63:48] = MSAD_U8(S0[55:24], S1[31:0], S2[63:48]); D[47:32] = MSAD_U8(S0[47:16], S1[31:0], S2[47:32]); D[31:16] = MSAD_U8(S0[39:8], S1[31:0], S2[31:16]); D[15:0] = MSAD_U8(S0[31:0], S1[31:0], S2[15:0]).</pre>
372	V_TRIG_PREOP_F64	<p>Look Up 2/PI (S0.d) with segment select S1.u[4:0]. This operation returns an aligned, double precision segment of 2/PI needed to do range reduction on S0.d (double-precision value). Multiple segments can be specified through S1.u[4:0]. Rounding is round-to-zero. Large inputs (exp &gt; 1968) are scaled to avoid loss of precision through denormalization.</p> <pre> shift = S1.u * 53; if exponent(S0.d) &gt; 1077 then     shift += exponent(S0.d) - 1077; endif result = (double) ((2/PI[1200:0] &lt;&lt; shift) &amp; 0x1fffff_ffffffff); scale = (-53 - shift); if exponent(S0.d) &gt;= 1968 then     scale += 128; endif D.d = ldexp(result, scale).</pre>

Opcode	Name	Description
373	V_MQSAD_U32_U8	Quad-byte masked SAD with 32-bit packed accumulation.  $D[127:96] = \text{MSAD\_U8}(S0[55:24], S1[31:0], S2[127:96]);$ $D[95:64] = \text{MSAD\_U8}(S0[47:16], S1[31:0], S2[95:64]);$ $D[63:32] = \text{MSAD\_U8}(S0[39:8], S1[31:0], S2[63:32]);$ $D[31:0] = \text{MSAD\_U8}(S0[31:0], S1[31:0], S2[31:0]).$
374	V_MAD_U64_U32	Multiply and add unsigned integers and produce a 64-bit result.  $\{vcc\_out, D.u64\} = S0.u32 * S1.u32 + S2.u64.$
375	V_MAD_I64_I32	Multiply and add signed integers and produce a 64-bit result.  $\{vcc\_out, D.i64\} = S0.i32 * S1.i32 + S2.i64.$
376	V_XOR3_B32	Bitwise XOR of three inputs. Input and output modifiers not supported.  $D.u32 = S0.u32 \wedge S1.u32 \wedge S2.u32.$
767	V_LSHLREV_B64	Logical shift left, count is in the first operand. Only one scalar broadcast constant is allowed.  $D.u64 = S1.u64 \ll S0.u[5:0].$
768	V_LSHRREV_B64	Logical shift right, count is in the first operand. Only one scalar broadcast constant is allowed.  $D.u64 = S1.u64 \gg S0.u[5:0].$
769	V_ASHRREV_I64	Arithmetic shift right (preserve sign bit), count is in the first operand. Only one scalar broadcast constant is allowed.  $D.u64 = \text{signext}(S1.u64) \gg S0.u[5:0].$
771	V_ADD_NC_U16	Add two unsigned shorts. Supports saturation (unsigned 16-bit integer domain). No carry-in or carry-out.  $D.u16 = S0.u16 + S1.u16.$
772	V_SUB_NC_U16	Subtract the second unsigned short from the first. Supports saturation (unsigned 16-bit integer domain). No carry-in or carry-out.  $D.u16 = S0.u16 - S1.u16.$
773	V_MUL_LO_U16	Multiply two unsigned shorts. Supports saturation (unsigned 16-bit integer domain).  $D.u16 = S0.u16 * S1.u16.$
775	V_LSHRREV_B16	Logical shift right, count is in the first operand.  $D.u[15:0] = S1.u[15:0] \gg S0.u[3:0].$
776	V_ASHRREV_I16	Arithmetic shift right (preserve sign bit), count is in the first operand.  $D.i[15:0] = \text{signext}(S1.i[15:0]) \gg S0.i[3:0].$

Opcode	Name	Description
777	V_MAX_U16	Maximum of two unsigned shorts. $D.u16 = (S0.u16 \geq S1.u16 ? S0.u16 : S1.u16).$
778	V_MAX_I16	Maximum of two signed shorts. $D.i16 = (S0.i16 \geq S1.i16 ? S0.i16 : S1.i16).$
779	V_MIN_U16	Minimum of two unsigned shorts. $D.u16 = (S0.u16 < S1.u16 ? S0.u16 : S1.u16).$
780	V_MIN_I16	Minimum of two signed shorts. $D.i16 = (S0.i16 < S1.i16 ? S0.i16 : S1.i16).$
781	V_ADD_NC_I16	Add two signed shorts. Supports saturation (signed 16-bit integer domain). No carry-in or carry-out. $D.i16 = S0.i16 + S1.i16.$
782	V_SUB_NC_I16	Subtract the second signed short from the first. Supports saturation (unsigned 16-bit integer domain). No carry-in or carry-out. $D.i16 = S0.i16 - S1.i16.$
783	V_ADD_CO_U32	Add two unsigned integers with carry-out. In VOP3 the VCC destination may be an arbitrary SGPR-pair. $D.u32 = S0.u32 + S1.u32;$ $VCC = S0.u + S1.u \geq 0x100000000ULL ? 1 : 0.$
784	V_SUB_CO_U32	Subtract the second unsigned integer from the first with carry-out. In VOP3 the VCC destination may be an arbitrary SGPR-pair. $D.u = S0.u - S1.u;$ $VCC[threadId] = (S1.u > S0.u ? 1 : 0).$ // VCC is an UNSIGNED overflow/carry-out for V_SUB_CO_CI_U32.
785	V_PACK_B32_F16	Pack two FP16 values together. $D[31:16].f16 = S1.f16;$ $D[15:0].f16 = S0.f16.$
786	V_CVT_PKNORM_I16_F16	Convert two FP16 values into packed signed normalized shorts. $D = \{(snorm)S1.f16, (snorm)S0.f16\}.$
787	V_CVT_PKNORM_U16_F16	Convert two FP16 values into packed unsigned normalized shorts. $D = \{(unorm)S1.f16, (unorm)S0.f16\}.$
788	V_LSHLREV_B16	Logical shift left, count is in the first operand. $D.u[15:0] = S1.u[15:0] \ll S0.u[3:0].$

Opcode	Name	Description
793	V_SUBREV_CO_U32	<p>Subtract the first unsigned integer from the second with carry-out. In VOP3 the VCC destination may be an arbitrary SGPR-pair.</p> $D.u = S1.u - S0.u;$ $VCC[threadId] = (S0.u > S1.u ? 1 : 0).$ <p>// VCC is an UNSIGNED overflow/carry-out for V_SUB_CO_CI_U32.</p>
832	V_MAD_U16	<p>Multiply and add unsigned shorts. Supports saturation (unsigned 16-bit integer domain).</p> <p>If op_sel[3] is 0: Result is written to 16 LSBs of destination VGPR and hi 16 bits are preserved.</p> <p>If op_sel[3] is 1: Result is written to 16 MSBs of destination VGPR and lo 16 bits are preserved.</p> $D.u16 = S0.u16 * S1.u16 + S2.u16.$
834	V_INTERP_P1LL_F16	<p>FP16 parameter interpolation. 'LL' stands for 'two LDS arguments'. attr_word selects the high or low half 16 bits of each LDS dword accessed. This opcode is available for 32-bank LDS only.</p> <p>NOTE: In textual representations the I/J VGPR is the first source and the attribute is the second source; however in the VOP3 encoding the attribute is stored in the src0 field and the VGPR is stored in the src1 field.</p> $D.f32 = P10.f16 * S0.f32 + P0.f16.$
835	V_INTERP_P1LV_F16	<p>FP16 parameter interpolation. 'LV' stands for 'One LDS and one VGPR argument'. S2 holds two parameters, attr_word selects the high or low word of the VGPR for this calculation, as well as the high or low half of the LDS data. Meant for use with 16-bank LDS.</p> <p>NOTE: In textual representations the I/J VGPR is the first source and the attribute is the second source; however in the VOP3 encoding the attribute is stored in the src0 field and the VGPR is stored in the src1 field.</p> $D.f32 = P10.f16 * S0.f32 + (S2.u32 >> (attr\_word * 16)).f16.$

Opcode	Name	Description
836	V_PERM_B32	<p>Byte permute.</p> <pre> D.u[31:24] = byte_permute({S0.u, S1.u}, S2.u[31:24]); D.u[23:16] = byte_permute({S0.u, S1.u}, S2.u[23:16]); D.u[15:8] = byte_permute({S0.u, S1.u}, S2.u[15:8]); D.u[7:0] = byte_permute({S0.u, S1.u}, S2.u[7:0]);  byte permute(byte in[8], byte sel) {   if(sel&gt;=13) then return 0xff;   elsif(sel==12) then return 0x00;   elsif(sel==11) then return in[7][7] * 0xff;   elsif(sel==10) then return in[5][7] * 0xff;   elsif(sel==9) then return in[3][7] * 0xff;   elsif(sel==8) then return in[1][7] * 0xff;   else return in[sel]; } </pre>
837	V_XAD_U32	<p>Bitwise XOR and then add. No carryin/carryout and no saturation. This opcode exists to accelerate the SHA256 hash algorithm.</p> <pre> D.u32 = (S0.u32 ^ S1.u32) + S2.u32. </pre>
838	V_LSHL_ADD_U32	<p>Logical shift left and then add.</p> <pre> D.u = (S0.u &lt;&lt; S1.u[4:0]) + S2.u. </pre>
839	V_ADD_LSHL_U32	<p>Add and then logical shift left the result.</p> <pre> D.u = (S0.u + S1.u) &lt;&lt; S2.u[4:0]. </pre>
843	V_FMA_F16	<p>Fused half precision multiply add of FP16 values. 0.5ULP accuracy, denormals are supported.</p> <p>If op_sel[3] is 0 Result is written to 16 LSBs of destination VGPR and hi 16 bits are preserved.</p> <p>If op_sel[3] is 1 Result is written to 16 MSBs of destination VGPR and lo 16 bits are preserved.</p> <pre> D.f16 = S0.f16 * S1.f16 + S2.f16. </pre>
849	V_MIN3_F16	<p>Return minimum FP16 value of three inputs.</p> <pre> D.f16 = V_MIN_F16(V_MIN_F16(S0.f16, S1.f16), S2.f16). </pre>
850	V_MIN3_I16	<p>Return minimum signed short value of three inputs.</p> <pre> D.i16 = V_MIN_I16(V_MIN_I16(S0.i16, S1.i16), S2.i16). </pre>
851	V_MIN3_U16	<p>Return minimum unsigned short value of three inputs.</p> <pre> D.u16 = V_MIN_U16(V_MIN_U16(S0.u16, S1.u16), S2.u16). </pre>
852	V_MAX3_F16	<p>Return maximum FP16 value of three inputs.</p> <pre> D.f16 = V_MAX_F16(V_MAX_F16(S0.f16, S1.f16), S2.f16). </pre>
853	V_MAX3_I16	<p>Return maximum signed short value of three inputs.</p> <pre> D.i16 = V_MAX_I16(V_MAX_I16(S0.i16, S1.i16), S2.i16). </pre>

Opcode	Name	Description
854	V_MAX3_U16	Return maximum unsigned short value of three inputs.  D.u16 = V_MAX_U16(V_MAX_U16(S0.u16, S1.u16), S2.u16).
855	V_MED3_F16	Return median FP16 value of three inputs.  if (isNaN(S0.f16)    isNaN(S1.f16)    isNaN(S2.f16)) D.f16 = V_MIN3_F16(S0.f16, S1.f16, S2.f16); else if (V_MAX3_F16(S0.f16, S1.f16, S2.f16) == S0.f16) D.f16 = V_MAX_F16(S1.f16, S2.f16); else if (V_MAX3_F16(S0.f16, S1.f16, S2.f16) == S1.f16) D.f16 = V_MAX_F16(S0.f16, S2.f16); else D.f16 = V_MAX_F16(S0.f16, S1.f16); endif.
856	V_MED3_I16	Return median signed short value of three inputs.  if (V_MAX3_I16(S0.i16, S1.i16, S2.i16) == S0.i16) D.i16 = V_MAX_I16(S1.i16, S2.i16); else if (V_MAX3_I16(S0.i16, S1.i16, S2.i16) == S1.i16) D.i16 = V_MAX_I16(S0.i16, S2.i16); else D.i16 = V_MAX_I16(S0.i16, S1.i16); endif.
857	V_MED3_U16	Return median unsigned short value of three inputs.  if (V_MAX3_U16(S0.u16, S1.u16, S2.u16) == S0.u16) D.u16 = V_MAX_U16(S1.u16, S2.u16); else if (V_MAX3_U16(S0.u16, S1.u16, S2.u16) == S1.u16) D.u16 = V_MAX_U16(S0.u16, S2.u16); else D.u16 = V_MAX_U16(S0.u16, S1.u16); endif.
858	V_INTERP_P2_F16	FP16 parameter interpolation. Final computation. attr_word selects LDS high or low 16bits. Used for both 16- and 32-bank LDS.  NOTE: In textual representations the I/J VGPR is the first source and the attribute is the second source; however in the VOP3 encoding the attribute is stored in the src0 field and the VGPR is stored in the src1 field.  If op_sel[3] is 0 Result is written to 16 LSBs of destination VGPR and hi 16 bits are preserved.  If op_sel[3] is 1 Result is written to 16 MSBs of destination VGPR and lo 16 bits are preserved.  D.f16 = P20.f16 * S0.f32 + S2.f32.

Opcode	Name	Description
862	V_MAD_I16	<p>Multiply and add signed short values. Supports saturation (signed 16-bit integer domain).</p> <p>If op_sel[3] is 0 Result is written to 16 LSBs of destination VGPR and hi 16 bits are preserved.</p> <p>If op_sel[3] is 1 Result is written to 16 MSBs of destination VGPR and lo 16 bits are preserved.</p> $D.i16 = S0.i16 * S1.i16 + S2.i16.$
863	V_DIV_FIXUP_F16	<p>Half precision division fixup. S0 = Quotient, S1 = Denominator, S2 = Numerator.</p> <p>Given a numerator, denominator, and quotient from a divide, this opcode will detect and apply specific case numerics, touching up the quotient if necessary. This opcode also generates invalid, denorm and divide by zero exceptions caused by the division.</p> <p>If op_sel[3] is 0 Result is written to 16 LSBs of destination VGPR and hi 16 bits are preserved.</p> <p>If op_sel[3] is 1 Result is written to 16 MSBs of destination VGPR and lo 16 bits are preserved.</p> <pre> sign_out = sign(S1.f16)^sign(S2.f16); if (S2.f16 == NAN)     D.f16 = Quiet(S2.f16); else if (S1.f16 == NAN)     D.f16 = Quiet(S1.f16); else if (S1.f16 == S2.f16 == 0)     // 0/0     D.f16 = 0xfe00; else if (abs(S1.f16) == abs(S2.f16) == +-INF)     // inf/inf     D.f16 = 0xfe00; else if (S1.f16 ==0    abs(S2.f16) == +-INF)     // x/0, or inf/y     D.f16 = sign_out ? -INF : +INF; else if (abs(S1.f16) == +-INF    S2.f16 == 0)     // x/inf, 0/y     D.f16 = sign_out ? -0 : 0; else     D.f16 = sign_out ? -abs(S0.f16) : abs(S0.f16); end if. </pre>
864	V_READLANE_B32	<p>Copy one VGPR value to one SGPR. D = SGPR-dest, S0 = Source Data (VGPR# or M0(lds-direct)), S1 = Lane Select (SGPR or M0). Lane is S1 % (32 if wave32, 64 if wave64). Ignores exec mask.</p> <p>Input and output modifiers not supported; this is an untyped operation.</p> <pre> if(wave32)     SMEM[D_ADDR] = VMEM[S0_ADDR][S1[4:0]]; // For wave32 else     SMEM[D_ADDR] = VMEM[S0_ADDR][S1[5:0]]; // For wave64 endif. </pre>

Opcode	Name	Description
865	V_WRITELANE_B32	<p>Write value into one VGPR in one lane. D = VGPR-dest, S0 = Source Data (sgpr, m0, exec or constants), S1 = Lane Select (SGPR or M0). Lane is S1 % (32 if wave32, 64 if wave64). Ignores exec mask.</p> <p>Input and output modifiers not supported; this is an untyped operation.</p> <pre> if(wave32)     VMEM[D_ADDR][S1[4:0]] = SMEM[S0_ADDR]; // For wave32 else     VMEM[D_ADDR][S1[5:0]] = SMEM[S0_ADDR]; // For wave64 endif.</pre>
866	V_LDEXP_F32	<p>Multiply a single-precision float by an integral power of 2, compare with the ldexp() function in C.</p> <pre>D.f = S0.f * (2 ** S1.i).</pre>
867	V_BFM_B32	<p>Bitfield modify. S0 is the bitfield width and S1 is the bitfield offset.</p> <pre>D.u32 = ((1&lt;&lt;S0[4:0])-1) &lt;&lt; S1[4:0].</pre>
868	V_BCNT_U32_B32	<p>Bit count.</p> <pre> D.u = S1.u; for i in 0 .. 31 do     D.u += S0.u[i]; // count i'th bit endfor.</pre>
869	V_MBCNT_LO_U32_B32	<p>Masked bit count, ThreadPosition is the position of this thread in the wavefront (in 0..63). See also V_MBCNT_HI_U32_B32.</p> <pre> ThreadMask = (1LL &lt;&lt; ThreadPosition) - 1; MaskedValue = (S0.u &amp; ThreadMask[31:0]); D.u = S1.u; for i in 0 ... 31 do     D.u += (MaskedValue[i] == 1 ? 1 : 0); endfor.</pre>
870	V_MBCNT_HI_U32_B32	<p>Masked bit count, ThreadPosition is the position of this thread in the wavefront (in 0..63). See also V_MBCNT_LO_U32_B32. Note that in Wave32 mode ThreadMask[63:32] == 0 and this instruction simply performs a move from S1 to D.</p> <pre> ThreadMask = (1LL &lt;&lt; ThreadPosition) - 1; MaskedValue = (S0.u &amp; ThreadMask[63:32]); D.u = S1.u; for i in 0 ... 31 do     D.u += (MaskedValue[i] == 1 ? 1 : 0); endfor.</pre> <p>Example to compute each thread's position in 0..63:</p> <pre> v_mbcnt_lo_u32_b32 v0, -1, 0 v_mbcnt_hi_u32_b32 v0, -1, v0 // v0 now contains ThreadPosition</pre>



Opcode	Name	Description
872	V_CVT_PKNORM_I16_F32	Convert two single-precision floats into a packed signed normalized value.  $D.i16\_lo = (snorm)S0.f32;$ $D.i16\_hi = (snorm)S1.f32.$
873	V_CVT_PKNORM_U16_F32	Convert two single-precision floats into a packed unsigned normalized value.  $D.u16\_lo = (unorm)S0.f32;$ $D.u16\_hi = (unorm)S1.f32.$
874	V_CVT_PK_U16_U32	Convert two unsigned integers into a packed unsigned short.  $D.u16\_lo = u32\_to\_u16(S0.u32);$ $D.u16\_hi = u32\_to\_u16(S1.u32).$
875	V_CVT_PK_I16_I32	Convert two signed integers into a packed signed short.  $D.i16\_lo = i32\_to\_i16(S0.i32);$ $D.i16\_hi = i32\_to\_i16(S1.i32).$
877	V_ADD3_U32	Add three unsigned integers.  $D.u = S0.u + S1.u + S2.u.$
879	V_LSHL_OR_B32	Logical shift left and then bitwise OR.  $D.u = (S0.u \ll S1.u[4:0])   S2.u.$
881	V_AND_OR_B32	Bitwise AND and then bitwise OR.  $D.u = (S0.u \& S1.u)   S2.u.$
882	V_OR3_B32	Bitwise OR of three inputs.  $D.u = S0.u   S1.u   S2.u.$
883	V_MAD_U32_U16	Multiply and add unsigned values.  $D.u32 = S0.u16 * S1.u16 + S2.u32.$
885	V_MAD_I32_I16	Multiply and add signed values.  $D.i32 = S0.i16 * S1.i16 + S2.i32.$
886	V_SUB_NC_I32	Subtract the second signed integer from the first. No carry-in or carry-out. Supports saturation (signed 32-bit integer domain).  $D.i = S0.i - S1.i.$

Opcode	Name	Description
887	V_PERMLANE16_B32	<p>Perform arbitrary gather-style operation within a row (16 contiguous lanes).</p> <p>The first source must be a VGPR and the second and third sources must be scalar values; the second and third source are combined into a single 64-bit value representing lane selects used to swizzle within each row.</p> <p>OP_SEL is not used in its typical manner for this instruction. For this instruction OP_SEL[0] is overloaded to represent the DPP 'FI' (Fetch Inactive) bit and OP_SEL[1] is overloaded to represent the DPP 'BOUND_CTRL' bit. The remainin OP_SEL bits are reserved for this instruction.</p> <p>ABS, NEG and OMOD modifiers should all be zeroed for this instruction.</p> <p>Compare with V_PERMLANEX16_B32.</p> <pre> lanesel = { S2.u, S1.u }; // Concatenate lane select bits for row in 0 ... 3 do // interval is 0 ... 1 for wave32 mode     // Implement arbitrary swizzle within each row     for i in 0 ... 15 do         D.lane[row * 16 + i] = S0.lane[row * 16 + lanesel[i * 4 + 3:i * 4]];     endfor; endfor.                     </pre> <p>Example implementing a rotation within each row:</p> <pre> v_mov_b32 s0, 0x87654321; v_mov_b32 s1, 0x0fedcba9; v_permlane16_b32 v1, v0, s0, s1; // ROW 0: // v1.lane[0] &lt;-- v0.lane[1] // v1.lane[1] &lt;-- v0.lane[2] // ... // v1.lane[14] &lt;-- v0.lane[15] // v1.lane[15] &lt;-- v0.lane[0] // // ROW 1: // v1.lane[16] &lt;-- v0.lane[17] // v1.lane[17] &lt;-- v0.lane[18] // ... // v1.lane[30] &lt;-- v0.lane[31] // v1.lane[31] &lt;-- v0.lane[16]                     </pre>

Opcode	Name	Description
888	V_PERMLANEX16_B32	<p>Perform arbitrary gather-style operation across two rows (each row is 16 contiguous lanes).</p> <p>The first source must be a VGPR and the second and third sources must be scalar values; the second and third source are combined into a single 64-bit value representing lane selects used to swizzle within each row.</p> <p>OP_SEL is not used in its typical manner for this instruction. For this instruction OP_SEL[0] is overloaded to represent the DPP 'FI' (Fetch Inactive) bit and OP_SEL[1] is overloaded to represent the DPP 'BOUND_CTRL' bit. The remainin OP_SEL bits are reserved for this instruction.</p> <p>ABS, NEG and OMOD modifiers should all be zeroed for this instruction.</p> <p>Compare with V_PERMLANE16_B32.</p> <pre> lanesel = { S2.u, S1.u }; // Concatenate lane select bits for row in 0 ... 3 do // interval is 0 ... 1 for wave32 mode   // Implement arbitrary swizzle across two rows   altrow = {row[1], ~row[0]}; // 1&lt;-&gt;0, 3&lt;-&gt;2   for i in 0 ... 15 do     D.lane[row * 16 + i] = S0.lane[altrow * 16 + lanesel[i * 4 + 3:i * 4]];   endfor; endfor. </pre> <p>Example implementing a rotation across an entire wave32 wavefront:</p> <pre> // Note for this to work, source and destination VGPRs must be different. // For this rotation, lane 15 gets data from lane 16, lane 31 gets data from lane 0. // These are the only two lanes that need to use v_permlanex16_b32.  v_mov_b32 exec_lo, 0x7fff7fff; // Lanes getting data from their own row v_mov_b32 s0, 0x87654321; v_mov_b32 s1, 0x0fedcba9; v_permlane16_b32 v1, v0, s0, s1 fi; // FI bit needed for lanes 14 and 30  v_mov_b32 exec_lo, 0x80008000; // Lanes getting data from the other row v_permlanex16_b32 v1, v0, s0, s1 fi; // FI bit needed for lanes 15 and 31 </pre>
895	V_ADD_NC_I32	<p>Add two signed integers. No carry-in or carry-out. Supports saturation (signed 32-bit integer domain). No carry-in or carry-out.</p> <pre> D.i = S0.i + S1.i. </pre>

## 12.13. LDS & GDS Instructions

This suite of instructions operates on data stored within the data share memory. The instructions transfer data between VGPRs and data share memory.

The bitfield map for the LDS/GDS is:

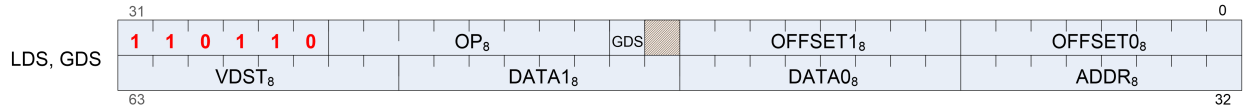

where:

- OFFSET0 = Unsigned byte offset added to the address from the ADDR VGPR.
- OFFSET1 = Unsigned byte offset added to the address from the ADDR VGPR.
- GDS = Set if GDS, cleared if LDS.
- OP = DS instruction opcode
- ADDR = Source LDS address VGPR 0 - 255.
- DATA0 = Source data0 VGPR 0 - 255.
- DATA1 = Source data1 VGPR 0 - 255.
- V DST = Destination VGPR 0- 255.



All instructions with RTN in the name return the value that was in memory before the operation was performed.

Opcode	Name	Description
0	DS_ADD_U32	// 32bit tmp = MEM[ADDR]; MEM[ADDR] += DATA; RETURN_DATA = tmp.
1	DS_SUB_U32	// 32bit tmp = MEM[ADDR]; MEM[ADDR] -= DATA; RETURN_DATA = tmp.
2	DS_RSUB_U32	Subtraction with reversed operands.  // 32bit addr = VGPR[ADDR]+{INST1,INST0}; tmp = DS[addr].u32; DS[addr].u32 = VGPR[DATA0].u32-DS[addr].u32; VGPR[V DST].u32 = tmp.
3	DS_INC_U32	// 32bit tmp = MEM[ADDR]; MEM[ADDR] = (tmp >= DATA) ? 0 : tmp + 1; // unsigned compare RETURN_DATA = tmp.
4	DS_DEC_U32	// 32bit tmp = MEM[ADDR]; MEM[ADDR] = (tmp == 0    tmp > DATA) ? DATA : tmp - 1; // unsigned compare RETURN_DATA = tmp.

Opcode	Name	Description
5	DS_MIN_I32	<pre>// 32bit tmp = MEM[ADDR]; MEM[ADDR] = (DATA &lt; tmp) ? DATA : tmp; // signed compare RETURN_DATA = tmp.</pre>
6	DS_MAX_I32	<pre>// 32bit tmp = MEM[ADDR]; MEM[ADDR] = (DATA &gt; tmp) ? DATA : tmp; // signed compare RETURN_DATA = tmp.</pre>
7	DS_MIN_U32	<pre>// 32bit tmp = MEM[ADDR]; MEM[ADDR] = (DATA &lt; tmp) ? DATA : tmp; // unsigned compare RETURN_DATA = tmp.</pre>
8	DS_MAX_U32	<pre>// 32bit tmp = MEM[ADDR]; MEM[ADDR] = (DATA &gt; tmp) ? DATA : tmp; // unsigned compare RETURN_DATA = tmp.</pre>
9	DS_AND_B32	<pre>// 32bit tmp = MEM[ADDR]; MEM[ADDR] &amp;= DATA; RETURN_DATA = tmp.</pre>
10	DS_OR_B32	<pre>// 32bit tmp = MEM[ADDR]; MEM[ADDR]  = DATA; RETURN_DATA = tmp.</pre>
11	DS_XOR_B32	<pre>// 32bit tmp = MEM[ADDR]; MEM[ADDR] ^= DATA; RETURN_DATA = tmp.</pre>
12	DS_MSKOR_B32	<p>Masked dword OR, D0 contains the mask and D1 contains the new value.</p> <pre>// 32bit tmp = MEM[ADDR]; MEM[ADDR] = (MEM[ADDR] &amp; ~DATA)   DATA2; RETURN_DATA = tmp.</pre>
13	DS_WRITE_B32	<p>Write dword.</p> <pre>// 32bit MEM[ADDR] = DATA.</pre>
14	DS_WRITE2_B32	<p>Write 2 dwords.</p> <pre>// 32bit MEM[ADDR + OFFSET0 * 4] = DATA; MEM[ADDR + OFFSET1 * 4] = DATA2.</pre>
15	DS_WRITE2ST64_B32	<p>Write 2 dwords with larger stride.</p> <pre>// 32bit MEM[ADDR + OFFSET0 * 4 * 64] = DATA; MEM[ADDR + OFFSET1 * 4 * 64] = DATA2.</pre>

Opcode	Name	Description
16	DS_CMPST_B32	<p>Compare and store. Caution, the order of src and cmp are the *opposite* of the BUFFER_ATOMIC_CMPSWAP opcode.</p> <pre>// 32bit tmp = MEM[ADDR]; src = DATA2; cmp = DATA; MEM[ADDR] = (tmp == cmp) ? src : tmp; RETURN_DATA[0] = tmp.</pre>
17	DS_CMPST_F32	<p>Floating point compare and store that handles NaN/INF/denormal values. Caution, the order of src and cmp are the *opposite* of the BUFFER_ATOMIC_FCMPSWAP opcode.</p> <pre>// 32bit tmp = MEM[ADDR]; src = DATA2; cmp = DATA; MEM[ADDR] = (tmp == cmp) ? src : tmp; RETURN_DATA[0] = tmp.</pre>
18	DS_MIN_F32	<p>Floating point minimum that handles NaN/INF/denormal values. Note that this opcode is slightly more general-purpose than BUFFER_ATOMIC_FMIN.</p> <pre>// 32bit tmp = MEM[ADDR]; src = DATA; cmp = DATA2; MEM[ADDR] = (cmp &lt; tmp) ? src : tmp.</pre>
19	DS_MAX_F32	<p>Floating point maximum that handles NaN/INF/denormal values. Note that this opcode is slightly more general-purpose than BUFFER_ATOMIC_FMAX.</p> <pre>// 32bit tmp = MEM[ADDR]; src = DATA; cmp = DATA2; MEM[ADDR] = (tmp &gt; cmp) ? src : tmp.</pre>
20	DS_NOP	Do nothing.
21	DS_ADD_F32	<p>Floating point add that handles NaN/INF/denormal values.</p> <pre>float tmp = MEM[ADDR].f32; MEM[ADDR].f32 += DATA0.f32; VDST.f32 = tmp;</pre>

Opcode	Name	Description
24	DS_GWS_SEMA_RELEA SE_ALL	<p>GDS Only: The GWS resource (rid) indicated will process this opcode by updating the counter and labeling the specified resource as a semaphore.</p> <pre> // Determine the GWS resource to work on rid[5:0] = gds_base[5:0] + offset0[5:0];  // Incr the state counter of the resource state.counter[rid] = state.wave_in_queue; state.type = SEMAPHORE; return rd_done; //release calling wave                     </pre> <p>This action will release ALL queued waves; it Will have no effect if no waves are present.</p>
25	DS_GWS_INIT	<p>GDS Only: Initialize a barrier or semaphore resource.</p> <pre> // Determine the GWS resource to work on rid[5:0] = gds_base[5:0] + offset0[5:0];  // Get the value to use in init index = find_first_valid(vector mask) value = DATA[thread: index]  // Set the state of the resource state.counter[rid] = lsb(value); //limit #waves state.flag[rid] = 0; return rd_done; //release calling wave                     </pre>
26	DS_GWS_SEMA_V	<p>GDS Only: The GWS resource indicated will process this opcode by updating the counter and labeling the resource as a semaphore.</p> <pre> //Determine the GWS resource to work on rid[5:0] = gds_base[5:0] + offset0[5:0];  //Incr the state counter of the resource state.counter[rid] += 1; state.type = SEMAPHORE; return rd_done; //release calling wave                     </pre> <p>This action will release one waved if any are queued in this resource.</p>

Opcode	Name	Description
27	DS_GWS_SEMA_BR	<p>GDS Only: The GWS resource indicated will process this opcode by updating the counter by the bulk release delivered count and labeling the resource as a semaphore.</p> <pre data-bbox="646 321 1138 594"> //Determine the GWS resource to work on rid[5:0] = gds_base[5:0] + offset0[5:0]; index = find first valid (vector mask) count = DATA[thread: index];  //Add count to the resource state counter state.counter[rid] += count; state.type = SEMAPHORE; return rd_done; //release calling wave                     </pre> <p>This action will release count number of waves, promptly if queued, or as they arrive from the noted resource.</p>
28	DS_GWS_SEMA_P	<p>GDS Only: The GWS resource indicated will process this opcode by queueing it until counter enables a release and then decrementing the counter of the resource as a semaphore.</p> <pre data-bbox="646 831 1125 1010"> //Determine the GWS resource to work on rid[5:0] = gds_base[5:0] + offset0[5:0]; state.type = SEMAPHORE; ENQUEUE until(state[rid].counter &gt; 0) state[rid].counter -= 1; return rd_done;                     </pre>



Opcode	Name	Description
29	DS_GWS_BARRIER	<p>GDS Only: The GWS resource indicated will process this opcode by queueing it until barrier is satisfied. The number of waves needed is passed in as DATA of first valid thread.</p> <pre>//Determine the GWS resource to work on rid[5:0] = gds_base[5:0] + OFFSET0[5:0]; index = find first valid (vector mask); value = DATA[thread: index];  // Input Decision Machine state.type[rid] = BARRIER; if(state[rid].counter &lt;= 0) then     thread[rid].flag = state[rid].flag;     ENQUEUE;     state[rid].flag = !state.flag;     state[rid].counter = value;     return rd_done; else     state[rid].counter -= 1;     thread.flag = state[rid].flag;     ENQUEUE; endif.</pre> <p>Since the waves deliver the count for the next barrier, this function can have a different size barrier for each occurrence.</p> <pre>// Release Machine if(state.type == BARRIER) then     if(state.flag != thread.flag) then         return rd_done;     endif; endif.</pre>
30	DS_WRITE_B8	<p>Byte write.</p> <pre>MEM[ADDR] = DATA[7:0].</pre>
31	DS_WRITE_B16	<p>Short write.</p> <pre>MEM[ADDR] = DATA[15:0].</pre>
32	DS_ADD_RTN_U32	<pre>// 32bit tmp = MEM[ADDR]; MEM[ADDR] += DATA; RETURN_DATA = tmp.</pre>
33	DS_SUB_RTN_U32	<pre>// 32bit tmp = MEM[ADDR]; MEM[ADDR] -= DATA; RETURN_DATA = tmp.</pre>
34	DS_RSUB_RTN_U32	<p>Subtraction with reversed operands.</p> <pre>// 32bit addr = VGPR[ADDR]+{INST1, INST0}; tmp = DS[addr].u32; DS[addr].u32 = VGPR[DATA0].u32-DS[addr].u32; VGPR[VDST].u32 = tmp.</pre>

Opcode	Name	Description
35	DS_INC_RTN_U32	<pre>// 32bit tmp = MEM[ADDR]; MEM[ADDR] = (tmp &gt;= DATA) ? 0 : tmp + 1; // unsigned compare RETURN_DATA = tmp.</pre>
36	DS_DEC_RTN_U32	<pre>// 32bit tmp = MEM[ADDR]; MEM[ADDR] = (tmp == 0    tmp &gt; DATA) ? DATA : tmp - 1; // unsigned compare RETURN_DATA = tmp.</pre>
37	DS_MIN_RTN_I32	<pre>// 32bit tmp = MEM[ADDR]; MEM[ADDR] = (DATA &lt; tmp) ? DATA : tmp; // signed compare RETURN_DATA = tmp.</pre>
38	DS_MAX_RTN_I32	<pre>// 32bit tmp = MEM[ADDR]; MEM[ADDR] = (DATA &gt; tmp) ? DATA : tmp; // signed compare RETURN_DATA = tmp.</pre>
39	DS_MIN_RTN_U32	<pre>// 32bit tmp = MEM[ADDR]; MEM[ADDR] = (DATA &lt; tmp) ? DATA : tmp; // unsigned compare RETURN_DATA = tmp.</pre>
40	DS_MAX_RTN_U32	<pre>// 32bit tmp = MEM[ADDR]; MEM[ADDR] = (DATA &gt; tmp) ? DATA : tmp; // unsigned compare RETURN_DATA = tmp.</pre>
41	DS_AND_RTN_B32	<pre>// 32bit tmp = MEM[ADDR]; MEM[ADDR] &amp;= DATA; RETURN_DATA = tmp.</pre>
42	DS_OR_RTN_B32	<pre>// 32bit tmp = MEM[ADDR]; MEM[ADDR]  = DATA; RETURN_DATA = tmp.</pre>
43	DS_XOR_RTN_B32	<pre>// 32bit tmp = MEM[ADDR]; MEM[ADDR] ^= DATA; RETURN_DATA = tmp.</pre>
44	DS_MSKOR_RTN_B32	<p>Masked dword OR, D0 contains the mask and D1 contains the new value.</p> <pre>// 32bit tmp = MEM[ADDR]; MEM[ADDR] = (MEM[ADDR] &amp; ~DATA)   DATA2; RETURN_DATA = tmp.</pre>
45	DS_WRXCHG_RTN_B32	<p>Write-exchange operation.</p> <pre>tmp = MEM[ADDR]; MEM[ADDR] = DATA; RETURN_DATA = tmp.</pre>

Opcode	Name	Description
46	DS_WRXCHG2_RTN_B32	Write-exchange 2 separate dwords.
47	DS_WRXCHG2ST64_RTN_B32	Write-exchange 2 separate dwords with a stride of 64 dwords.
48	DS_CMPST_RTN_B32	Compare and store. Caution, the order of src and cmp are the <i>*opposite*</i> of the BUFFER_ATOMIC_CMPSWAP opcode.  <pre>// 32bit tmp = MEM[ADDR]; src = DATA2; cmp = DATA; MEM[ADDR] = (tmp == cmp) ? src : tmp; RETURN_DATA[0] = tmp.</pre>
49	DS_CMPST_RTN_F32	Floating point compare and store that handles NaN/INF/denormal values. Caution, the order of src and cmp are the <i>*opposite*</i> of the BUFFER_ATOMIC_FCMPSWAP opcode.  <pre>// 32bit tmp = MEM[ADDR]; src = DATA2; cmp = DATA; MEM[ADDR] = (tmp == cmp) ? src : tmp; RETURN_DATA[0] = tmp.</pre>
50	DS_MIN_RTN_F32	Floating point minimum that handles NaN/INF/denormal values. Note that this opcode is slightly more general-purpose than BUFFER_ATOMIC_FMIN.  <pre>// 32bit tmp = MEM[ADDR]; src = DATA; cmp = DATA2; MEM[ADDR] = (cmp &lt; tmp) ? src : tmp.</pre>
51	DS_MAX_RTN_F32	Floating point maximum that handles NaN/INF/denormal values. Note that this opcode is slightly more general-purpose than BUFFER_ATOMIC_FMAX.  <pre>// 32bit tmp = MEM[ADDR]; src = DATA; cmp = DATA2; MEM[ADDR] = (tmp &gt; cmp) ? src : tmp.</pre>
52	DS_WRAP_RTN_B32	<pre>tmp = MEM[ADDR]; MEM[ADDR] = (tmp &gt;= DATA) ? tmp - DATA : tmp + DATA2; RETURN_DATA = tmp.</pre>
53	DS_SWIZZLE_B32	Dword swizzle, no data is written to LDS memory. See next section for details.
54	DS_READ_B32	Dword read.  <pre>RETURN_DATA = MEM[ADDR].</pre>

Opcode	Name	Description
55	DS_READ2_B32	Read 2 dwords.  <pre>RETURN_DATA[0] = MEM[ADDR + OFFSET0 * 4]; RETURN_DATA[1] = MEM[ADDR + OFFSET1 * 4].</pre>
56	DS_READ2ST64_B32	Read 2 dwords with a larger stride.  <pre>RETURN_DATA[0] = MEM[ADDR + OFFSET0 * 4 * 64]; RETURN_DATA[1] = MEM[ADDR + OFFSET1 * 4 * 64].</pre>
57	DS_READ_I8	Signed byte read.  <pre>RETURN_DATA = signext(MEM[ADDR][7:0]).</pre>
58	DS_READ_U8	Unsigned byte read.  <pre>RETURN_DATA = {24'h0, MEM[ADDR][7:0]}.</pre>
59	DS_READ_I16	Signed short read.  <pre>RETURN_DATA = signext(MEM[ADDR][15:0]).</pre>
60	DS_READ_U16	Unsigned short read.  <pre>RETURN_DATA = {16'h0, MEM[ADDR][15:0]}.</pre>
61	DS_CONSUME	LDS & GDS. Subtract (count_bits(exec_mask)) from the value stored in DS memory at (M0.base + instr_offset). Return the pre-operation value to VGPRs.  <p>The DS will subtract count_bits(vector valid mask) from the value stored at address M0.base + instruction based offset and return the pre-op value to all valid lanes. This op can be used in both the LDS and GDS. In the LDS this address will be an offset to HWBASE and clamped by M0.size, but in the GDS the M0.base constant will have the physical GDS address and the compiler must force offset to zero. In GDS it is for the traditional append buffer operations. In LDS it is for local thread group appends and can be used to regroup divergent threads. The use of the M0 register enables the compiler to do indexing of UAV append/consume counters.</p> <p>For GDS (system wide) consume, the compiler must use a zero for {offset1,offset0}, for LDS the compiler will use {offset1,offset0} to provide the relative address to the append counter in the LDS for runtime index offset or index.</p> <p>Inside DS --- Do one atomic add for first valid lane and broadcast result to all valid lanes. Offset = offset1:offset0; Interpreted as byte offset --- For 10xx LDS designs only aligned atomics are supported, so 2 lsbs of offset must be set to zero.</p> <pre>addr = M0.base + offset; // offset by LDS HWBASE, limit to M.size rtnval = LDS(addr); LDS(addr) = LDS(addr) - countbits(valid mask); GPR[VDST] = rtnval; // return to all valid threads</pre>

Opcode	Name	Description
62	DS_APPEND	<p>LDS &amp; GDS. Add (count_bits(exec_mask)) to the value stored in DS memory at (M0.base + instr_offset). Return the pre-operation value to VGPRs.</p> <p>The DS will add count_bits(vector valid mask) from the value stored at address M0.base + instruction based offset and return the pre-op value to all valid lanes. This op can be used in both the LDS and GDS. In the LDS this address will be an offset to HWBASE and clamped by M0.size, but in the GDS the M0.base constant will have the physical GDS address and the compiler must set offset to zero. In GDS it is for the traditional append buffer operations. In LDS it is for local thread group appends and can be used to regroup divergent threads. The use of the M0 register enables the compiler to do indexing of UAV append/consume counters.</p> <p>For GDS (system wide) consume, the compiler must use a zero for {offset1,offset0}, for LDS the compiler will use {offset1,offset0} to provide the relative address to the append counter in the LDS for runtime index offset or index.</p> <p>Inside DS --- Do one atomic add for first valid lane and broadcast result to all valid lanes. Offset = 0offset1:offset0; Interpreted as byte offset --- For 10xx LDS designs only aligned atomics will be supported, so 2 lsbs of offset must be set to zero.</p> <pre> addr = M0.base + offset; // offset by LDS HWBASE, limit to M.size rtnval = LDS(addr); LDS(addr) = LDS(addr) + countbits(valid mask); GPR[VDST] = rtnval; // return to all valid threads                     </pre>

Opcode	Name	Description
63	DS_ORDERED_COUNT	<p>GDS-only. Add (count_bits(exec_mask)) to one of 4 dedicated ordered-count counters (aka 'packers'). Additional bits of instr.offset field are overloaded to hold packer-id, 'last'.</p> <p>GDS Only: Intercepted by GDS and processed by ordered append module. The ordered append module will queue request until this request wave is the oldest in the queue at which time the oldest wave request will be dispatched to the DS with an atomic add for execution and broadcast back to ALL lanes of a wave. This is an ordered count operation and can only be called once per issue with the release flag set. If the release flag is not set, the wave will have full control over the order count module until it sends a request with the release flag set.</p> <p>Unlike append/consume this op needs to be sent even if there are no valid lanes when it is issued. The GDS will add zero and advance the tracking walker that needs to match up with the dispatch counter.</p> <p>The shader will send the following data to identify which wave to return the result to:</p> <p>The shader will send the following pipeline_ID to the ordered count unit to be used to select the correct pipeline's tracking data. Additionally pixel waves will use 4 counters depending on the packer sourcing the pixel waves and generating the launch order.</p> <pre> Pipeline_id = ring_id + !pixel wave type;     0 = ring0 pixel wave     1 = ring0 CS     2 = ring1 CS     3 = ring2 CS Physical_wave_id = {se_id, sh_id, wave_buf_id}                     </pre> <p>GDS_size from the M0.size register contains the pkr_id (set at wave creation time) and logical_wave_id for pixel waves and launch order logical wave_id for compute shaders.</p> <p>The pixel shader uses four counters for each instance, so the pkr_id will need to be added to the gds_base to act on the correct counter.</p> <pre> index = find first valid (vector mask) count = src0[index][31:0]; Pkr_id = gds_size[1:0]; gds_atomic_address[15:2] = gds_base[15:2] will contain the dword address in the ds for the count accumulation counter. ds_address[15:2] = gds_base[15:2] + offset0[7:2] + (pipeline_id == 0)?Pkr_id:0 //2 new control signals Wave_release = Offset1[0]; Wave_done = offset1[1]; Pixel_wave = offset1[2];                     </pre> <p>If this control is not set, hold the crawler until wave does an additional access with the wave_release the wave. This feature allows one wavefront to issue serial access to the any of the</p>

Opcode	Name	Description
64	DS_ADD_U64	<pre>// 64bit tmp = MEM[ADDR]; MEM[ADDR] += DATA[0:1]; RETURN_DATA[0:1] = tmp.</pre>
65	DS_SUB_U64	<pre>// 64bit tmp = MEM[ADDR]; MEM[ADDR] -= DATA[0:1]; RETURN_DATA[0:1] = tmp.</pre>
66	DS_RSUB_U64	<p>Subtraction with reversed operands.</p> <pre>// 64bit tmp = MEM[ADDR]; MEM[ADDR] = DATA - MEM[ADDR]; RETURN_DATA = tmp.</pre>
67	DS_INC_U64	<pre>// 64bit tmp = MEM[ADDR]; MEM[ADDR] = (tmp &gt;= DATA[0:1]) ? 0 : tmp + 1; // unsigned compare RETURN_DATA[0:1] = tmp.</pre>
68	DS_DEC_U64	<pre>// 64bit tmp = MEM[ADDR]; MEM[ADDR] = (tmp == 0    tmp &gt; DATA[0:1]) ? DATA[0:1] : tmp - 1; // unsigned compare RETURN_DATA[0:1] = tmp.</pre>
69	DS_MIN_I64	<pre>// 64bit tmp = MEM[ADDR]; MEM[ADDR] = (DATA[0:1] &lt; tmp) ? DATA[0:1] : tmp; // signed compare RETURN_DATA[0:1] = tmp.</pre>
70	DS_MAX_I64	<pre>// 64bit tmp = MEM[ADDR]; MEM[ADDR] = (DATA[0:1] &gt; tmp) ? DATA[0:1] : tmp; // signed compare RETURN_DATA[0:1] = tmp.</pre>
71	DS_MIN_U64	<pre>// 64bit tmp = MEM[ADDR]; MEM[ADDR] = (DATA[0:1] &lt; tmp) ? DATA[0:1] : tmp; // unsigned compare RETURN_DATA[0:1] = tmp.</pre>
72	DS_MAX_U64	<pre>// 64bit tmp = MEM[ADDR]; MEM[ADDR] = (DATA[0:1] &gt; tmp) ? DATA[0:1] : tmp; // unsigned compare RETURN_DATA[0:1] = tmp.</pre>
73	DS_AND_B64	<pre>// 64bit tmp = MEM[ADDR]; MEM[ADDR] &amp;= DATA[0:1]; RETURN_DATA[0:1] = tmp.</pre>

Opcode	Name	Description
74	DS_OR_B64	<pre>// 64bit tmp = MEM[ADDR]; MEM[ADDR]  = DATA[0:1]; RETURN_DATA[0:1] = tmp.</pre>
75	DS_XOR_B64	<pre>// 64bit tmp = MEM[ADDR]; MEM[ADDR] ^= DATA[0:1]; RETURN_DATA[0:1] = tmp.</pre>
76	DS_MSKOR_B64	<p>Masked dword OR, D0 contains the mask and D1 contains the new value.</p> <pre>// 64bit tmp = MEM[ADDR]; MEM[ADDR] = (MEM[ADDR] &amp; ~DATA)   DATA2; RETURN_DATA = tmp.</pre>
77	DS_WRITE_B64	<p>Write qword.</p> <pre>// 64bit MEM[ADDR] = DATA.</pre>
78	DS_WRITE2_B64	<p>Write 2 qwords.</p> <pre>// 64bit MEM[ADDR + OFFSET0 * 8] = DATA; MEM[ADDR + OFFSET1 * 8] = DATA2.</pre>
79	DS_WRITE2ST64_B64	<p>Write 2 qwords with a larger stride.</p> <pre>// 64bit MEM[ADDR + OFFSET0 * 8 * 64] = DATA; MEM[ADDR + OFFSET1 * 8 * 64] = DATA2.</pre>
80	DS_CMPST_B64	<p>Compare and store. Caution, the order of src and cmp are the *opposite* of the BUFFER_ATOMIC_CMPSWAP_X2 opcode.</p> <pre>// 64bit tmp = MEM[ADDR]; src = DATA2; cmp = DATA; MEM[ADDR] = (tmp == cmp) ? src : tmp; RETURN_DATA[0] = tmp.</pre>
81	DS_CMPST_F64	<p>Floating point compare and store that handles NaN/INF/denormal values. Caution, the order of src and cmp are the *opposite* of the BUFFER_ATOMIC_FCMPSWAP_X2 opcode.</p> <pre>// 64bit tmp = MEM[ADDR]; src = DATA2; cmp = DATA; MEM[ADDR] = (tmp == cmp) ? src : tmp; RETURN_DATA[0] = tmp.</pre>



Opcode	Name	Description
82	DS_MIN_F64	<p>Floating point minimum that handles NaN/INF/denormal values. Note that this opcode is slightly more general-purpose than BUFFER_ATOMIC_FMIN_X2.</p> <pre>// 64bit tmp = MEM[ADDR]; src = DATA; cmp = DATA2; MEM[ADDR] = (cmp &lt; tmp) ? src : tmp.</pre>
83	DS_MAX_F64	<p>Floating point maximum that handles NaN/INF/denormal values. Note that this opcode is slightly more general-purpose than BUFFER_ATOMIC_FMAX_X2.</p> <pre>// 64bit tmp = MEM[ADDR]; src = DATA; cmp = DATA2; MEM[ADDR] = (tmp &gt; cmp) ? src : tmp.</pre>
85	DS_ADD_RTN_F32	<p>Floating point add that handles NaN/INF/denormal values.</p> <pre>float tmp = MEM[ADDR].f32; MEM[ADDR].f32 += DATA0.f32; VDST.f32 = tmp;</pre>
96	DS_ADD_RTN_U64	<pre>// 64bit tmp = MEM[ADDR]; MEM[ADDR] += DATA[0:1]; RETURN_DATA[0:1] = tmp.</pre>
97	DS_SUB_RTN_U64	<pre>// 64bit tmp = MEM[ADDR]; MEM[ADDR] -= DATA[0:1]; RETURN_DATA[0:1] = tmp.</pre>
98	DS_RSUB_RTN_U64	<p>Subtraction with reversed operands.</p> <pre>// 64bit tmp = MEM[ADDR]; MEM[ADDR] = DATA - MEM[ADDR]; RETURN_DATA = tmp.</pre>
99	DS_INC_RTN_U64	<pre>// 64bit tmp = MEM[ADDR]; MEM[ADDR] = (tmp &gt;= DATA[0:1]) ? 0 : tmp + 1; // unsigned compare RETURN_DATA[0:1] = tmp.</pre>
100	DS_DEC_RTN_U64	<pre>// 64bit tmp = MEM[ADDR]; MEM[ADDR] = (tmp == 0    tmp &gt; DATA[0:1]) ? DATA[0:1] : tmp - 1; // unsigned compare RETURN_DATA[0:1] = tmp.</pre>
101	DS_MIN_RTN_I64	<pre>// 64bit tmp = MEM[ADDR]; MEM[ADDR] = (DATA[0:1] &lt; tmp) ? DATA[0:1] : tmp; // signed compare RETURN_DATA[0:1] = tmp.</pre>

Opcode	Name	Description
102	DS_MAX_RTN_I64	<pre>// 64bit tmp = MEM[ADDR]; MEM[ADDR] = (DATA[0:1] &gt; tmp) ? DATA[0:1] : tmp; // signed compare RETURN_DATA[0:1] = tmp.</pre>
103	DS_MIN_RTN_U64	<pre>// 64bit tmp = MEM[ADDR]; MEM[ADDR] = (DATA[0:1] &lt; tmp) ? DATA[0:1] : tmp; // unsigned compare RETURN_DATA[0:1] = tmp.</pre>
104	DS_MAX_RTN_U64	<pre>// 64bit tmp = MEM[ADDR]; MEM[ADDR] = (DATA[0:1] &gt; tmp) ? DATA[0:1] : tmp; // unsigned compare RETURN_DATA[0:1] = tmp.</pre>
105	DS_AND_RTN_B64	<pre>// 64bit tmp = MEM[ADDR]; MEM[ADDR] &amp;= DATA[0:1]; RETURN_DATA[0:1] = tmp.</pre>
106	DS_OR_RTN_B64	<pre>// 64bit tmp = MEM[ADDR]; MEM[ADDR]  = DATA[0:1]; RETURN_DATA[0:1] = tmp.</pre>
107	DS_XOR_RTN_B64	<pre>// 64bit tmp = MEM[ADDR]; MEM[ADDR] ^= DATA[0:1]; RETURN_DATA[0:1] = tmp.</pre>
108	DS_MSKOR_RTN_B64	<p>Masked dword OR, D0 contains the mask and D1 contains the new value.</p> <pre>// 64bit tmp = MEM[ADDR]; MEM[ADDR] = (MEM[ADDR] &amp; ~DATA)   DATA2; RETURN_DATA = tmp.</pre>
109	DS_WRXCHG_RTN_B64	<p>Write-exchange operation.</p> <pre>tmp = MEM[ADDR]; MEM[ADDR] = DATA; RETURN_DATA = tmp.</pre>
110	DS_WRXCHG2_RTN_B64	<p>Write-exchange 2 separate qwords.</p>
111	DS_WRXCHG2ST64_RTN_B64	<p>Write-exchange 2 qwords with a stride of 64 qwords.</p>

Opcode	Name	Description
112	DS_CMPST_RTN_B64	<p>Compare and store. Caution, the order of src and cmp are the *opposite* of the BUFFER_ATOMIC_CMPSWAP_X2 opcode.</p> <pre>// 64bit tmp = MEM[ADDR]; src = DATA2; cmp = DATA; MEM[ADDR] = (tmp == cmp) ? src : tmp; RETURN_DATA[0] = tmp.</pre>
113	DS_CMPST_RTN_F64	<p>Floating point compare and store that handles NaN/INF/denormal values. Caution, the order of src and cmp are the *opposite* of the BUFFER_ATOMIC_FCMPSWAP_X2 opcode.</p> <pre>// 64bit tmp = MEM[ADDR]; src = DATA2; cmp = DATA; MEM[ADDR] = (tmp == cmp) ? src : tmp; RETURN_DATA[0] = tmp.</pre>
114	DS_MIN_RTN_F64	<p>Floating point minimum that handles NaN/INF/denormal values. Note that this opcode is slightly more general-purpose than BUFFER_ATOMIC_FMIN_X2.</p> <pre>// 64bit tmp = MEM[ADDR]; src = DATA; cmp = DATA2; MEM[ADDR] = (cmp &lt; tmp) ? src : tmp.</pre>
115	DS_MAX_RTN_F64	<p>Floating point maximum that handles NaN/INF/denormal values. Note that this opcode is slightly more general-purpose than BUFFER_ATOMIC_FMAX_X2.</p> <pre>// 64bit tmp = MEM[ADDR]; src = DATA; cmp = DATA2; MEM[ADDR] = (tmp &gt; cmp) ? src : tmp.</pre>
118	DS_READ_B64	<p>Read 1 qword.</p> <pre>RETURN_DATA = MEM[ADDR].</pre>
119	DS_READ2_B64	<p>Read 2 qwords.</p> <pre>RETURN_DATA[0] = MEM[ADDR + OFFSET0 * 8]; RETURN_DATA[1] = MEM[ADDR + OFFSET1 * 8].</pre>
120	DS_READ2ST64_B64	<p>Read 2 qwords with a larger stride.</p> <pre>RETURN_DATA[0] = MEM[ADDR + OFFSET0 * 8 * 64]; RETURN_DATA[1] = MEM[ADDR + OFFSET1 * 8 * 64].</pre>
126	DS_CONDXCHG32_RTN_B64	<p>Conditional write exchange.</p>

Opcode	Name	Description
160	DS_WRITE_B8_D16_HI	Byte write in to high word.  MEM[ADDR] = DATA[23:16].
161	DS_WRITE_B16_D16_HI	Short write in to high word.  MEM[ADDR] = DATA[31:16].
162	DS_READ_U8_D16	Unsigned byte read with masked return to lower word.  RETURN_DATA[15:0] = {8'h0, MEM[ADDR][7:0]}.
163	DS_READ_U8_D16_HI	Unsigned byte read with masked return to upper word.  RETURN_DATA[31:16] = {8'h0, MEM[ADDR][7:0]}.
164	DS_READ_I8_D16	Signed byte read with masked return to lower word.  RETURN_DATA[15:0] = signext(MEM[ADDR][7:0]).
165	DS_READ_I8_D16_HI	Signed byte read with masked return to upper word.  RETURN_DATA[31:16] = signext(MEM[ADDR][7:0]).
166	DS_READ_U16_D16	Unsigned short read with masked return to lower word.  RETURN_DATA[15:0] = MEM[ADDR][15:0].
167	DS_READ_U16_D16_HI	Unsigned short read with masked return to upper word.  RETURN_DATA[31:0] = MEM[ADDR][15:0].
176	DS_WRITE_ADDTID_B32	Write dword with thread ID offset.  LDS_GS[LDS_BASE + {OFFSET1, OFFSET0} + M0[15:0] + TID*4].u32 = VGPR[DATA0].u32
177	DS_READ_ADDTID_B32	Dword read with thread ID offset.  VGPR[VDST].u32 = LDS_GS[LDS_BASE + {OFFSET1, OFFSET0} + M0[15:0] + TID*4].u32

Opcode	Name	Description
178	DS_PERMUTE_B32	<pre> // VGPR[index][thread_id] is the VGPR RAM // VDST, ADDR and DATA0 are from the microcode DS encoding tmp[0..63] = 0 for i in 0..63 do   // If a source thread is disabled, it will not propagate data.   next if !EXEC[i]   // ADDR needs to be divided by 4.   // High-order bits are ignored.   dst_lane = floor((VGPR[ADDR][i] + OFFSET) / 4) mod 64   tmp[dst_lane] = VGPR[DATA0][i] endfor // Copy data into destination VGPRs. If multiple sources // select the same destination thread, the highest-numbered // source thread wins. for i in 0..63 do   next if !EXEC[i]   VGPR[VDST][i] = tmp[i] endfor </pre> <p>Forward permute. This does not access LDS memory and may be called even if no LDS memory is allocated to the wave. It uses LDS hardware to implement an arbitrary swizzle across threads in a wavefront.</p> <p>Note the address passed in is the thread ID multiplied by 4.</p> <p>If multiple sources map to the same destination lane, the final value is not predictable but will be the value from one of the writers.</p> <p>See also DS_BPERMUTE_B32.</p> <p>Examples (simplified 4-thread wavefronts):</p> <pre> VGPR[SRC0] = { A, B, C, D } VGPR[ADDR] = { 0, 0, 12, 4 } EXEC = 0xF, OFFSET = 0 VGPR[VDST] := { B, D, 0, C }  VGPR[SRC0] = { A, B, C, D } VGPR[ADDR] = { 0, 0, 12, 4 } EXEC = 0xA, OFFSET = 0 VGPR[VDST] := { -, D, -, 0 } </pre>

Opcode	Name	Description
179	DS_BPERMUTE_B32	<pre>// VGPR[index][thread_id] is the VGPR RAM // VDST, ADDR and DATA0 are from the microcode DS encoding tmp[0..63] = 0 for i in 0..63 do   // ADDR needs to be divided by 4.   // High-order bits are ignored.   src_lane = floor((VGPR[ADDR][i] + OFFSET) / 4) mod 64   // EXEC is applied to the source VGPR reads.   next if !EXEC[src_lane]   tmp[i] = VGPR[DATA0][src_lane] endfor // Copy data into destination VGPRs. Some source // data may be broadcast to multiple lanes. for i in 0..63 do   next if !EXEC[i]   VGPR[VDST][i] = tmp[i] endfor</pre> <p>Backward permute. This does not access LDS memory and may be called even if no LDS memory is allocated to the wave. It uses LDS hardware to implement an arbitrary swizzle across threads in a wavefront.</p> <p>Note the address passed in is the thread ID multiplied by 4.</p> <p>Note that EXEC mask is applied to both VGPR read and write. If src_lane selects a disabled thread, zero will be returned.</p> <p>See also DS_PERMUTE_B32.</p> <p>Examples (simplified 4-thread wavefronts):</p> <pre>VGPR[SRC0] = { A, B, C, D } VGPR[ADDR] = { 0, 0, 12, 4 } EXEC = 0xF, OFFSET = 0 VGPR[VDST] := { A, A, D, B }</pre> <pre>VGPR[SRC0] = { A, B, C, D } VGPR[ADDR] = { 0, 0, 12, 4 } EXEC = 0xA, OFFSET = 0 VGPR[VDST] := { -, 0, -, B }</pre>
222	DS_WRITE_B96	<p>Tri-dword write.</p> <pre>{MEM[ADDR + 8], MEM[ADDR + 4], MEM[ADDR]} = DATA[95:0].</pre>
223	DS_WRITE_B128	<p>Quad-dword write.</p> <pre>{MEM[ADDR + 12], MEM[ADDR + 8], MEM[ADDR + 4], MEM[ADDR]} = DATA[127:0].</pre>
254	DS_READ_B96	Tri-dword read.
255	DS_READ_B128	Quad-dword read.

### 12.13.1. DS\_SWIZZLE\_B32 Details

Dword swizzle, no data is written to LDS memory.

Swizzles input thread data based on offset mask and returns; note does not read or write the DS memory banks.

Note that reading from an invalid thread results in 0x0.

This opcode supports two specific modes, FFT and rotate, plus two basic modes which swizzle in groups of 4 or 32 consecutive threads.

The FFT mode (offset  $\geq$  0xe000) swizzles the input based on offset[4:0] to support FFT calculation. Example swizzles using input {1, 2, ... 20} are:

Offset[4:0]: Swizzle 0x00:

{1,11,9,19,5,15,d,1d,3,13,b,1b,7,17,f,1f,2,12,a,1a,6,16,e,1e,4,14,c,1c,8,18,10,20} 0x10:

{1,9,5,d,3,b,7,f,2,a,6,e,4,c,8,10,11,19,15,1d,13,1b,17,1f,12,1a,16,1e,14,1c,18,20} 0x1f: No swizzle

The rotate mode (offset  $\geq$  0xc000 and offset  $<$  0xe000) rotates the input either left (offset[10] == 0) or right (offset[10] == 1) a number of threads equal to offset[9:5]. The rotate mode also uses a mask value which can alter the rotate result. For example, mask == 1 will swap the odd threads across every other even thread (rotate left), or even threads across every other odd thread (rotate right).

Offset[9:5]: Swizzle 0x01, mask=0, rotate left:

{2,3,4,5,6,7,8,9,a,b,c,d,e,f,10,11,12,13,14,15,16,17,18,19,1a,1b,1c,1d,1e,1f,20,1} 0x01, mask=0, rotate right:

{20,1,2,3,4,5,6,7,8,9,a,b,c,d,e,f,10,11,12,13,14,15,16,17,18,19,1a,1b,1c,1d,1e,1f} 0x01, mask=1, rotate left:

{2,1,4,7,6,5,8,b,a,9,c,f,e,d,10,13,12,11,14,17,16,15,18,1b,1a,19,1c,1f,1e,1d,20,3} 0x01, mask=1, rotate right:

{1e,1,4,3,2,5,8,7,6,9,c,b,a,d,10,f,e,11,14,13,12,15,18,17,16,19,1c,1b,1a,1d,20,1f}

If offset  $<$  0xc000, one of the basic swizzle modes is used based on offset[15]. If offset[15] == 1, groups of 4 consecutive threads are swizzled together. If offset[15] == 0, all 32 threads are swizzled together.

The first basic swizzle mode (when offset[15] == 1) allows full data sharing between a group of 4 consecutive threads. Any thread within the group of 4 can get data from any other thread within the group of 4, specified by the corresponding offset bits --- [1:0] for the first thread, [3:2] for the second thread, [5:4] for the third thread, [7:6] for the fourth thread. Note that the offset bits apply to all groups of 4 within a wavefront; thus if offset[1:0] == 1, then thread0 will grab thread1, thread4 will grab thread5, etc.

The second basic swizzle mode (when offset[15] == 0) allows limited data sharing between 32

consecutive threads. In this case, the offset is used to specify a 5-bit xor-mask, 5-bit or-mask, and 5-bit and-mask used to generate a thread mapping. Note that the offset bits apply to each group of 32 within a wavefront. The details of the thread mapping are listed below. Some example usages:

SWAPX16 : xor\_mask = 0x10, or\_mask = 0x00, and\_mask = 0x1f

SWAPX8 : xor\_mask = 0x08, or\_mask = 0x00, and\_mask = 0x1f

SWAPX4 : xor\_mask = 0x04, or\_mask = 0x00, and\_mask = 0x1f

SWAPX2 : xor\_mask = 0x02, or\_mask = 0x00, and\_mask = 0x1f

SWAPX1 : xor\_mask = 0x01, or\_mask = 0x00, and\_mask = 0x1f

REVERSEX32 : xor\_mask = 0x1f, or\_mask = 0x00, and\_mask = 0x1f

REVERSEX16 : xor\_mask = 0x0f, or\_mask = 0x00, and\_mask = 0x1f

REVERSEX8 : xor\_mask = 0x07, or\_mask = 0x00, and\_mask = 0x1f

REVERSEX4 : xor\_mask = 0x03, or\_mask = 0x00, and\_mask = 0x1f

REVERSEX2 : xor\_mask = 0x01 or\_mask = 0x00, and\_mask = 0x1f

BCASTX32: xor\_mask = 0x00, or\_mask = thread, and\_mask = 0x00

BCASTX16: xor\_mask = 0x00, or\_mask = thread, and\_mask = 0x10

BCASTX8: xor\_mask = 0x00, or\_mask = thread, and\_mask = 0x18

BCASTX4: xor\_mask = 0x00, or\_mask = thread, and\_mask = 0x1c

BCASTX2: xor\_mask = 0x00, or\_mask = thread, and\_mask = 0x1e

Pseudocode follows:

```
offset = offset1:offset0;
```



```

if (offset >= 0xe000) {
    // FFT decomposition
    mask = offset[4:0];
    for (i = 0; i < 64; i++) {
        j = reverse_bits(i & 0x1f);
        j = (j >> count_ones(mask));
        j |= (i & mask);
        j |= i & 0x20;
        thread_out[i] = thread_valid[j] ? thread_in[j] : 0;
    }
}

```

```

} else if (offset >= 0xc000) { // rotate
    rotate = offset[9:5]; mask = offset[4:0]; if (offset[10]) { rotate = -rotate; }
    for (i = 0; i < 64; i++) { j = (i & mask) | ((i + rotate) & ~mask); j |= i & 0x20;
    thread_out[i] = thread_valid[j] ? thread_in[j] : 0; }
}

```

```

} else if (offset[15]) { // full data sharing within 4 consecutive threads
    for (i = 0; i < 64; i+=4) {
        thread_out[i+0] = thread_valid[i+offset[1:0]]?thread_in[i+offset[1:0]]:0;
        thread_out[i+1] = thread_valid[i+offset[3:2]]?thread_in[i+offset[3:2]]:0;
        thread_out[i+2] = thread_valid[i+offset[5:4]]?thread_in[i+offset[5:4]]:0;
        thread_out[i+3] = thread_valid[i+offset[7:6]]?thread_in[i+offset[7:6]]:0; }
}

```

```

} else { // offset[15] == 0 // limited data sharing within 32 consecutive threads
    xor_mask = offset[14:10]; or_mask = offset[9:5]; and_mask = offset[4:0];
    for (i = 0; i < 64; i++) { j = (((i & 0x1f) & and_mask) | or_mask) ^ xor_mask;
    j |= (i & 0x20); // which group of 32
    thread_out[i] = thread_valid[j] ? thread_in[j] : 0; } }
}

```

### 12.13.2. LDS Instruction Limitations

Some of the DS instructions are available only to GDS, not LDS. These are:

- DS\_GWS\_SEMA\_RELEASE\_ALL
- DS\_GWS\_INIT
- DS\_GWS\_SEMA\_V
- DS\_GWS\_SEMA\_BR
- DS\_GWS\_SEMA\_P
- DS\_GWS\_BARRIER
- DS\_ORDERED\_COUNT

## 12.14. MUBUF Instructions

The bitfield map of the MUBUF format is:

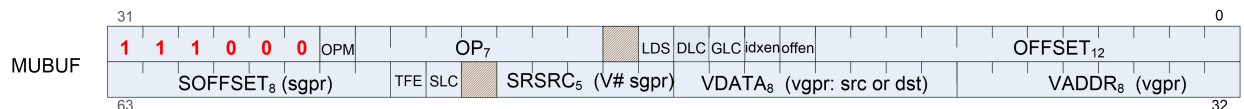

where:

OFFSET = Unsigned immediate byte offset.  
 OFFEN = Send offset either as VADDR or as zero..  
 IDXEN = Send index either as VADDR or as zero.  
 GLC = Global coherency.  
 LDS = Data read from/written to LDS or VGPR.  
 OP = Instruction Opcode.  
 VADDR = VGPR address source.  
 VDATA = Destination vector GPR.  
 SRSRC = Scalar GPR that specifies resource constant.  
 SLC = System level coherent.  
 TFE = Texture fail enable.  
 SOFFSET = Byte offset added to the memory address of an SGPR.

Opcode	Name	Description
0	BUFFER_LOAD_FORMAT_X	Untyped buffer load 1 dword with format conversion.
1	BUFFER_LOAD_FORMAT_XY	Untyped buffer load 2 dwords with format conversion.
2	BUFFER_LOAD_FORMAT_XYZ	Untyped buffer load 3 dwords with format conversion.
3	BUFFER_LOAD_FORMAT_XYZW	Untyped buffer load 4 dwords with format conversion.
4	BUFFER_STORE_FORMAT_X	Untyped buffer store 1 dword with format conversion.
5	BUFFER_STORE_FORMAT_XY	Untyped buffer store 2 dwords with format conversion.
6	BUFFER_STORE_FORMAT_XYZ	Untyped buffer store 3 dwords with format conversion.
7	BUFFER_STORE_FORMAT_XYZW	Untyped buffer store 4 dwords with format conversion.
8	BUFFER_LOAD_UBYTE	Untyped buffer load unsigned byte (zero extend to VGPR destination).
9	BUFFER_LOAD_SBYTE	Untyped buffer load signed byte (sign extend to VGPR destination).
10	BUFFER_LOAD_USHORT	Untyped buffer load unsigned short (zero extend to VGPR destination).
11	BUFFER_LOAD_SSHORT	Untyped buffer load signed short (sign extend to VGPR destination).
12	BUFFER_LOAD_DWORD	Untyped buffer load dword.
13	BUFFER_LOAD_DWORDX2	Untyped buffer load 2 dwords.
14	BUFFER_LOAD_DWORDX4	Untyped buffer load 4 dwords.
15	BUFFER_LOAD_DWORDX3	Untyped buffer load 3 dwords.
24	BUFFER_STORE_BYTE	Untyped buffer store byte. Stores S0[7:0].
25	BUFFER_STORE_BYTE_D16_HI	Untyped buffer store byte. Stores S0[23:16].
26	BUFFER_STORE_SHORT	Untyped buffer store short. Stores S0[15:0].
27	BUFFER_STORE_SHORT_D16_HI	Untyped buffer store short. Stores S0[31:16].
28	BUFFER_STORE_DWORD	Untyped buffer store dword.
29	BUFFER_STORE_DWORDX2	Untyped buffer store 2 dwords.

Opcode	Name	Description
30	BUFFER_STORE_DWORDX4	Untyped buffer store 4 dwords.
31	BUFFER_STORE_DWORDX3	Untyped buffer store 3 dwords.
32	BUFFER_LOAD_UBYTE_D16	$D0[15:0] = \{8'h0, MEM[ADDR]\}$ . Untyped buffer load unsigned byte.
33	BUFFER_LOAD_UBYTE_D16_HI	$D0[31:16] = \{8'h0, MEM[ADDR]\}$ . Untyped buffer load unsigned byte.
34	BUFFER_LOAD_SBYTE_D16	$D0[15:0] = \text{signext}(MEM[ADDR])$ . Untyped buffer load signed byte.
35	BUFFER_LOAD_SBYTE_D16_HI	$D0[31:16] = \text{signext}(MEM[ADDR])$ . Untyped buffer load signed byte.
36	BUFFER_LOAD_SHORT_D16	$D0[15:0] = MEM[ADDR]$ . Untyped buffer load short.
37	BUFFER_LOAD_SHORT_D16_HI	$D0[31:16] = MEM[ADDR]$ . Untyped buffer load short.
38	BUFFER_LOAD_FORMAT_D16_HI_X	$D0[31:16] = MEM[ADDR]$ . Untyped buffer load 1 dword with format conversion.
39	BUFFER_STORE_FORMAT_D16_HI_X	Untyped buffer store 1 dword with format conversion.
48	BUFFER_ATOMIC_SWAP	// 32bit tmp = MEM[ADDR]; MEM[ADDR] = DATA; RETURN_DATA = tmp.
49	BUFFER_ATOMIC_CMPSWAP	// 32bit tmp = MEM[ADDR]; src = DATA[0]; cmp = DATA[1]; MEM[ADDR] = (tmp == cmp) ? src : tmp; RETURN_DATA[0] = tmp.
50	BUFFER_ATOMIC_ADD	// 32bit tmp = MEM[ADDR]; MEM[ADDR] += DATA; RETURN_DATA = tmp.
51	BUFFER_ATOMIC_SUB	// 32bit tmp = MEM[ADDR]; MEM[ADDR] -= DATA; RETURN_DATA = tmp.

Opcode	Name	Description
52	BUFFER_ATOMIC_CSUB	<pre>// 32bit old_value = MEM[ADDR]; if old_value &lt; DATA then new_value = 0; else new_value = old_value - DATA; endif; MEM[addr] = new_value; RETURN_DATA = old_value.</pre>
53	BUFFER_ATOMIC_SMIN	<pre>// 32bit tmp = MEM[ADDR]; MEM[ADDR] = (DATA &lt; tmp) ? DATA : tmp; // signed compare RETURN_DATA = tmp.</pre>
54	BUFFER_ATOMIC_UMIN	<pre>// 32bit tmp = MEM[ADDR]; MEM[ADDR] = (DATA &lt; tmp) ? DATA : tmp; // unsigned compare RETURN_DATA = tmp.</pre>
55	BUFFER_ATOMIC_SMAX	<pre>// 32bit tmp = MEM[ADDR]; MEM[ADDR] = (DATA &gt; tmp) ? DATA : tmp; // signed compare RETURN_DATA = tmp.</pre>
56	BUFFER_ATOMIC_UMAX	<pre>// 32bit tmp = MEM[ADDR]; MEM[ADDR] = (DATA &gt; tmp) ? DATA : tmp; // unsigned compare RETURN_DATA = tmp.</pre>
57	BUFFER_ATOMIC_AND	<pre>// 32bit tmp = MEM[ADDR]; MEM[ADDR] &amp;= DATA; RETURN_DATA = tmp.</pre>
58	BUFFER_ATOMIC_OR	<pre>// 32bit tmp = MEM[ADDR]; MEM[ADDR]  = DATA; RETURN_DATA = tmp.</pre>
59	BUFFER_ATOMIC_XOR	<pre>// 32bit tmp = MEM[ADDR]; MEM[ADDR] ^= DATA; RETURN_DATA = tmp.</pre>
60	BUFFER_ATOMIC_INC	<pre>// 32bit tmp = MEM[ADDR]; MEM[ADDR] = (tmp &gt;= DATA) ? 0 : tmp + 1; // unsigned compare RETURN_DATA = tmp.</pre>
61	BUFFER_ATOMIC_DEC	<pre>// 32bit tmp = MEM[ADDR]; MEM[ADDR] = (tmp == 0    tmp &gt; DATA) ? DATA : tmp - 1; // unsigned compare RETURN_DATA = tmp.</pre>

Opcode	Name	Description
62	BUFFER_ATOMIC_FCMP_SWAP	<pre>// 32bit tmp = MEM[ADDR]; src = DATA[0]; cmp = DATA[1]; MEM[ADDR] = (tmp == cmp) ? src : tmp; RETURN_DATA[0] = tmp.</pre> <p>Floating-point compare swap (handles NaN/INF/denorm).</p>
63	BUFFER_ATOMIC_FMIN	<pre>// 32bit tmp = MEM[ADDR]; src = DATA[0]; MEM[ADDR] = (src &lt; tmp) ? src : tmp; RETURN_DATA[0] = tmp.</pre> <p>Floating-point compare (handles NaN/INF/denorm).</p>
64	BUFFER_ATOMIC_FMAX	<pre>// 32bit tmp = MEM[ADDR]; src = DATA[0]; MEM[ADDR] = (src &gt; tmp) ? src : tmp; RETURN_DATA[0] = tmp.</pre> <p>Floating-point compare (handles NaN/INF/denorm).</p>
80	BUFFER_ATOMIC_SWAP_X2	<pre>// 64bit tmp = MEM[ADDR]; MEM[ADDR] = DATA[0:1]; RETURN_DATA[0:1] = tmp.</pre>
81	BUFFER_ATOMIC_CMP_SWAP_X2	<pre>// 64bit tmp = MEM[ADDR]; src = DATA[0:1]; cmp = DATA[2:3]; MEM[ADDR] = (tmp == cmp) ? src : tmp; RETURN_DATA[0:1] = tmp.</pre>
82	BUFFER_ATOMIC_ADD_X2	<pre>// 64bit tmp = MEM[ADDR]; MEM[ADDR] += DATA[0:1]; RETURN_DATA[0:1] = tmp.</pre>
83	BUFFER_ATOMIC_SUB_X2	<pre>// 64bit tmp = MEM[ADDR]; MEM[ADDR] -= DATA[0:1]; RETURN_DATA[0:1] = tmp.</pre>
85	BUFFER_ATOMIC_SMIN_X2	<pre>// 64bit tmp = MEM[ADDR]; MEM[ADDR] = (DATA[0:1] &lt; tmp) ? DATA[0:1] : tmp; // signed compare RETURN_DATA[0:1] = tmp.</pre>
86	BUFFER_ATOMIC_UMIN_X2	<pre>// 64bit tmp = MEM[ADDR]; MEM[ADDR] = (DATA[0:1] &lt; tmp) ? DATA[0:1] : tmp; // unsigned compare RETURN_DATA[0:1] = tmp.</pre>

Opcode	Name	Description
87	BUFFER_ATOMIC_SMAX_X2	<pre>// 64bit tmp = MEM[ADDR]; MEM[ADDR] = (DATA[0:1] &gt; tmp) ? DATA[0:1] : tmp; // signed compare RETURN_DATA[0:1] = tmp.</pre>
88	BUFFER_ATOMIC_UMAX_X2	<pre>// 64bit tmp = MEM[ADDR]; MEM[ADDR] = (DATA[0:1] &gt; tmp) ? DATA[0:1] : tmp; // unsigned compare RETURN_DATA[0:1] = tmp.</pre>
89	BUFFER_ATOMIC_AND_X2	<pre>// 64bit tmp = MEM[ADDR]; MEM[ADDR] &amp;= DATA[0:1]; RETURN_DATA[0:1] = tmp.</pre>
90	BUFFER_ATOMIC_OR_X2	<pre>// 64bit tmp = MEM[ADDR]; MEM[ADDR]  = DATA[0:1]; RETURN_DATA[0:1] = tmp.</pre>
91	BUFFER_ATOMIC_XOR_X2	<pre>// 64bit tmp = MEM[ADDR]; MEM[ADDR] ^= DATA[0:1]; RETURN_DATA[0:1] = tmp.</pre>
92	BUFFER_ATOMIC_INC_X2	<pre>// 64bit tmp = MEM[ADDR]; MEM[ADDR] = (tmp &gt;= DATA[0:1]) ? 0 : tmp + 1; // unsigned compare RETURN_DATA[0:1] = tmp.</pre>
93	BUFFER_ATOMIC_DEC_X2	<pre>// 64bit tmp = MEM[ADDR]; MEM[ADDR] = (tmp == 0    tmp &gt; DATA[0:1]) ? DATA[0:1] : tmp - 1; // unsigned compare RETURN_DATA[0:1] = tmp.</pre>
94	BUFFER_ATOMIC_FCMP_SWAP_X2	<pre>// 64bit tmp = MEM[ADDR]; src = DATA[0]; cmp = DATA[1]; MEM[ADDR] = (tmp == cmp) ? src : tmp; RETURN_DATA[0] = tmp.</pre> <p>Floating-point compare swap (handles NaN/INF/denorm).</p>
95	BUFFER_ATOMIC_FMIN_X2	<pre>// 64bit tmp = MEM[ADDR]; src = DATA[0]; MEM[ADDR] = (src &lt; tmp) ? src : tmp; RETURN_DATA[0] = tmp.</pre> <p>Floating-point compare (handles NaN/INF/denorm).</p>

Opcode	Name	Description
96	BUFFER_ATOMIC_FMAX_X2	<pre>// 64bit tmp = MEM[ADDR]; src = DATA[0]; MEM[ADDR] = (src &gt; tmp) ? src : tmp; RETURN_DATA[0] = tmp.</pre> <p>Floating-point compare (handles NaN/INF/denorm).</p>
113	BUFFER_GLO_INV	Write back and invalidate the shader L0. Returns ACK to shader.
114	BUFFER_GL1_INV	Invalidate the GL1 cache only. Returns ACK to shader.
128	BUFFER_LOAD_FORMAT_D16_X	Untyped buffer load 1 dword with format conversion. D0[15:0] = MEM[ADDR].
129	BUFFER_LOAD_FORMAT_D16_XY	Untyped buffer load 1 dword with format conversion.
130	BUFFER_LOAD_FORMAT_D16_XYZ	Untyped buffer load 2 dwords with format conversion.
131	BUFFER_LOAD_FORMAT_D16_XYZW	Untyped buffer load 2 dwords with format conversion.
132	BUFFER_STORE_FORMAT_D16_X	Untyped buffer store 1 dword with format conversion.
133	BUFFER_STORE_FORMAT_D16_XY	Untyped buffer store 1 dword with format conversion.
134	BUFFER_STORE_FORMAT_D16_XYZ	Untyped buffer store 2 dwords with format conversion.
135	BUFFER_STORE_FORMAT_D16_XYZW	Untyped buffer store 2 dwords with format conversion.

## 12.15. MTBUF Instructions

The bitfield map of the MTBUF format is:

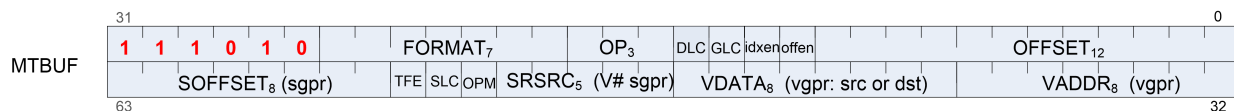

where:

- OFFSET = Unsigned immediate byte offset.
- OFFEN = Send offset either as VADDR or as zero.
- IDXEN = Send index either as VADDR or as zero.
- GLC = Global coherency.
- OP = Instruction Opcode.
- FORMAT = Data format for typed buffer.
- VADDR = VGPR address source.
- VDATA = Vector GPR for read/write result.
- SRSRC = Scalar GPR that specifies resource constant.
- SOFFSET = Unsigned byte offset from an SGPR.

Opcode	Name	Description
0	TBUFFER_LOAD_FORMAT_X	Typed buffer load 1 dword with format conversion.
1	TBUFFER_LOAD_FORMAT_XY	Typed buffer load 2 dwords with format conversion.
2	TBUFFER_LOAD_FORMAT_XYZ	Typed buffer load 3 dwords with format conversion.
3	TBUFFER_LOAD_FORMAT_XYZW	Typed buffer load 4 dwords with format conversion.
4	TBUFFER_STORE_FORMAT_X	Typed buffer store 1 dword with format conversion.
5	TBUFFER_STORE_FORMAT_XY	Typed buffer store 2 dwords with format conversion.
6	TBUFFER_STORE_FORMAT_XYZ	Typed buffer store 3 dwords with format conversion.
7	TBUFFER_STORE_FORMAT_XYZW	Typed buffer store 4 dwords with format conversion.
8	TBUFFER_LOAD_FORMAT_D16_X	Typed buffer load 1 dword with format conversion.
9	TBUFFER_LOAD_FORMAT_D16_XY	Typed buffer load 1 dword with format conversion.
10	TBUFFER_LOAD_FORMAT_D16_XYZ	Typed buffer load 2 dwords with format conversion.
11	TBUFFER_LOAD_FORMAT_D16_XYZW	Typed buffer load 2 dwords with format conversion.
12	TBUFFER_STORE_FORMAT_D16_X	Typed buffer store 1 dword with format conversion.
13	TBUFFER_STORE_FORMAT_D16_XY	Typed buffer store 1 dword with format conversion.
14	TBUFFER_STORE_FORMAT_D16_XYZ	Typed buffer store 2 dwords with format conversion.
15	TBUFFER_STORE_FORMAT_D16_XYZW	Typed buffer store 2 dwords with format conversion.

## 12.16. MIMG Instructions

The bitfield map of the MIMG format is:

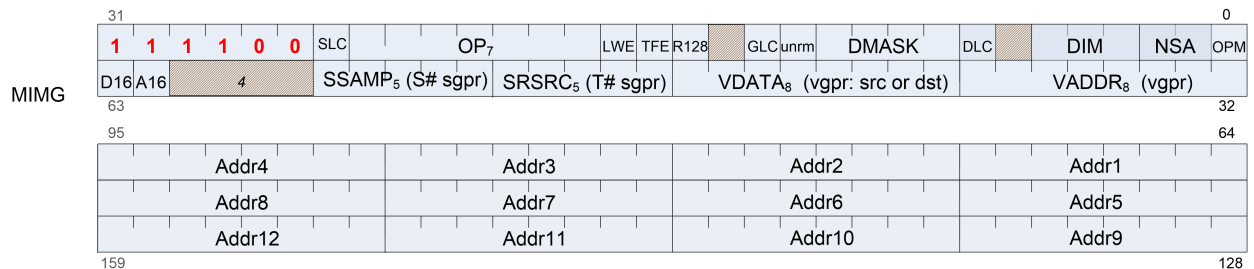



where:

- DMASK = Enable mask for image read/write data components.
- UNRM = Force address to be unnormalized.
- GLC = Global coherency.
- DA = Declare an array.
- A16 = Texture address component size.
- TFE = Texture fail enable.
- LWE = LOD warning enable.
- OP = Instruction Opcode.
- SLC = System level coherent.
- VADDR = VGPR address source.
- VDATA = Vector GPR for read/write result.
- SRSRC = Scalar GPR that specifies resource constant.
- SSAMP = Scalar GPR that specifies sampler constant.
- D16 = Data in VGPRs is 16 bits, not 32 bits.

Opcode	Name	Description
0	IMAGE_LOAD	Load element from largest miplevel in resource view, with format conversion specified in the resource constant. No sampler.
1	IMAGE_LOAD_MIP	Load element from user-specified miplevel in resource view, with format conversion specified in the resource constant. No sampler.
2	IMAGE_LOAD_PCK	Load element from largest miplevel in resource view, without format conversion. 8- and 16-bit elements are not sign-extended. No sampler.
3	IMAGE_LOAD_PCK_SGN	Load element from largest miplevel in resource view, without format conversion. 8- and 16-bit elements are sign-extended. No sampler.
4	IMAGE_LOAD_MIP_PCK	Load element from user-supplied miplevel in resource view, without format conversion. 8- and 16-bit elements are not sign-extended. No sampler.
5	IMAGE_LOAD_MIP_PCK_SGN	Load element from user-supplied miplevel in resource view, without format conversion. 8- and 16-bit elements are sign-extended. No sampler.
8	IMAGE_STORE	Store element to largest miplevel in resource view, with format conversion specified in resource constant. No sampler.
9	IMAGE_STORE_MIP	Store element to user-specified miplevel in resource view, with format conversion specified in resource constant. No sampler.
10	IMAGE_STORE_PCK	Store element to largest miplevel in resource view, without format conversion. No sampler.
11	IMAGE_STORE_MIP_PCK	Store element to user-specified miplevel in resource view, without format conversion. No sampler.
14	IMAGE_GET_RESINFO	Return resource info for a given mip level specified in the address vgpr. No sampler. Returns 4 integer values into VGPRs 3-0: {num_mip_levels, depth, height, width}.

Opcode	Name	Description
15	IMAGE_ATOMIC_SWAP	<pre>// 32bit tmp = MEM[ADDR]; MEM[ADDR] = DATA; RETURN_DATA = tmp.</pre>
16	IMAGE_ATOMIC_CMPSWAP	<pre>// 32bit tmp = MEM[ADDR]; src = DATA[0]; cmp = DATA[1]; MEM[ADDR] = (tmp == cmp) ? src : tmp; RETURN_DATA[0] = tmp.</pre>
17	IMAGE_ATOMIC_ADD	<pre>// 32bit tmp = MEM[ADDR]; MEM[ADDR] += DATA; RETURN_DATA = tmp.</pre>
18	IMAGE_ATOMIC_SUB	<pre>// 32bit tmp = MEM[ADDR]; MEM[ADDR] -= DATA; RETURN_DATA = tmp.</pre>
20	IMAGE_ATOMIC_SMIN	<pre>// 32bit tmp = MEM[ADDR]; MEM[ADDR] = (DATA &lt; tmp) ? DATA : tmp; // signed compare RETURN_DATA = tmp.</pre>
21	IMAGE_ATOMIC_UMIN	<pre>// 32bit tmp = MEM[ADDR]; MEM[ADDR] = (DATA &lt; tmp) ? DATA : tmp; // unsigned compare RETURN_DATA = tmp.</pre>
22	IMAGE_ATOMIC_SMAX	<pre>// 32bit tmp = MEM[ADDR]; MEM[ADDR] = (DATA &gt; tmp) ? DATA : tmp; // signed compare RETURN_DATA = tmp.</pre>
23	IMAGE_ATOMIC_UMAX	<pre>// 32bit tmp = MEM[ADDR]; MEM[ADDR] = (DATA &gt; tmp) ? DATA : tmp; // unsigned compare RETURN_DATA = tmp.</pre>
24	IMAGE_ATOMIC_AND	<pre>// 32bit tmp = MEM[ADDR]; MEM[ADDR] &amp;= DATA; RETURN_DATA = tmp.</pre>
25	IMAGE_ATOMIC_OR	<pre>// 32bit tmp = MEM[ADDR]; MEM[ADDR]  = DATA; RETURN_DATA = tmp.</pre>
26	IMAGE_ATOMIC_XOR	<pre>// 32bit tmp = MEM[ADDR]; MEM[ADDR] ^= DATA; RETURN_DATA = tmp.</pre>

Opcode	Name	Description
27	IMAGE_ATOMIC_INC	<pre>// 32bit tmp = MEM[ADDR]; MEM[ADDR] = (tmp &gt;= DATA) ? 0 : tmp + 1; // unsigned compare RETURN_DATA = tmp.</pre>
28	IMAGE_ATOMIC_DEC	<pre>// 32bit tmp = MEM[ADDR]; MEM[ADDR] = (tmp == 0    tmp &gt; DATA) ? DATA : tmp - 1; // unsigned compare RETURN_DATA = tmp.</pre>
29	IMAGE_ATOMIC_FCMPSWAP	<pre>// 32bit tmp = MEM[ADDR]; src = DATA[0]; cmp = DATA[1]; MEM[ADDR] = (tmp == cmp) ? src : tmp; RETURN_DATA[0] = tmp.</pre> <p>Floating-point compare swap (handles NaN/INF/denorm).</p>
30	IMAGE_ATOMIC_FMIN	<pre>// 32bit tmp = MEM[ADDR]; src = DATA[0]; MEM[ADDR] = (src &lt; tmp) ? src : tmp; RETURN_DATA[0] = tmp.</pre> <p>Floating-point compare (handles NaN/INF/denorm).</p>
31	IMAGE_ATOMIC_FMAX	<pre>// 32bit tmp = MEM[ADDR]; src = DATA[0]; MEM[ADDR] = (src &gt; tmp) ? src : tmp; RETURN_DATA[0] = tmp.</pre> <p>Floating-point compare (handles NaN/INF/denorm).</p>
32	IMAGE_SAMPLE	sample texture map.
33	IMAGE_SAMPLE_CL	sample texture map, with LOD clamp specified in shader.
34	IMAGE_SAMPLE_D	sample texture map, with user derivatives
35	IMAGE_SAMPLE_D_CL	sample texture map, with LOD clamp specified in shader, with user derivatives.
36	IMAGE_SAMPLE_L	sample texture map, with user LOD.
37	IMAGE_SAMPLE_B	sample texture map, with lod bias.
38	IMAGE_SAMPLE_B_CL	sample texture map, with LOD clamp specified in shader, with lod bias.
39	IMAGE_SAMPLE_LZ	sample texture map, from level 0.
40	IMAGE_SAMPLE_C	sample texture map, with PCF.
41	IMAGE_SAMPLE_C_CL	SAMPLE_C, with LOD clamp specified in shader.
42	IMAGE_SAMPLE_C_D	SAMPLE_C, with user derivatives.

Opcode	Name	Description
43	IMAGE_SAMPLE_C_D_CL	SAMPLE_C, with LOD clamp specified in shader, with user derivatives.
44	IMAGE_SAMPLE_C_L	SAMPLE_C, with user LOD.
45	IMAGE_SAMPLE_C_B	SAMPLE_C, with lod bias.
46	IMAGE_SAMPLE_C_B_CL	SAMPLE_C, with LOD clamp specified in shader, with lod bias.
47	IMAGE_SAMPLE_C_LZ	SAMPLE_C, from level 0.
48	IMAGE_SAMPLE_O	sample texture map, with user offsets.
49	IMAGE_SAMPLE_CL_O	SAMPLE_0 with LOD clamp specified in shader.
50	IMAGE_SAMPLE_D_O	SAMPLE_0, with user derivatives.
51	IMAGE_SAMPLE_D_CL_O	SAMPLE_0, with LOD clamp specified in shader, with user derivatives.
52	IMAGE_SAMPLE_L_O	SAMPLE_0, with user LOD.
53	IMAGE_SAMPLE_B_O	SAMPLE_0, with lod bias.
54	IMAGE_SAMPLE_B_CL_O	SAMPLE_0, with LOD clamp specified in shader, with lod bias.
55	IMAGE_SAMPLE_LZ_O	SAMPLE_0, from level 0.
56	IMAGE_SAMPLE_C_O	SAMPLE_C with user specified offsets.
57	IMAGE_SAMPLE_C_CL_O	SAMPLE_C_0, with LOD clamp specified in shader.
58	IMAGE_SAMPLE_C_D_O	SAMPLE_C_0, with user derivatives.
59	IMAGE_SAMPLE_C_D_CL_O	SAMPLE_C_0, with LOD clamp specified in shader, with user derivatives.
60	IMAGE_SAMPLE_C_L_O	SAMPLE_C_0, with user LOD.
61	IMAGE_SAMPLE_C_B_O	SAMPLE_C_0, with lod bias.
62	IMAGE_SAMPLE_C_B_CL_O	SAMPLE_C_0, with LOD clamp specified in shader, with lod bias.
63	IMAGE_SAMPLE_C_LZ_O	SAMPLE_C_0, from level 0.
64	IMAGE_GATHER4	gather 4 single component elements (2x2).
65	IMAGE_GATHER4_CL	gather 4 single component elements (2x2) with user LOD clamp.
68	IMAGE_GATHER4_L	gather 4 single component elements (2x2) with user LOD.
69	IMAGE_GATHER4_B	gather 4 single component elements (2x2) with user bias.
70	IMAGE_GATHER4_B_CL	gather 4 single component elements (2x2) with user bias and clamp.
71	IMAGE_GATHER4_LZ	gather 4 single component elements (2x2) at level 0.
72	IMAGE_GATHER4_C	gather 4 single component elements (2x2) with PCF.
73	IMAGE_GATHER4_C_CL	gather 4 single component elements (2x2) with user LOD clamp and PCF.
76	IMAGE_GATHER4_C_L	gather 4 single component elements (2x2) with user LOD and PCF.

Opcode	Name	Description
77	IMAGE_GATHER4_C_B	gather 4 single component elements (2x2) with user bias and PCF.
78	IMAGE_GATHER4_C_B_CL	gather 4 single component elements (2x2) with user bias, clamp and PCF.
79	IMAGE_GATHER4_C_LZ	gather 4 single component elements (2x2) at level 0, with PCF.
80	IMAGE_GATHER4_O	GATHER4, with user offsets.
81	IMAGE_GATHER4_CL_O	GATHER4_CL, with user offsets.
84	IMAGE_GATHER4_L_O	GATHER4_L, with user offsets.
85	IMAGE_GATHER4_B_O	GATHER4_B, with user offsets.
86	IMAGE_GATHER4_B_CL_O	GATHER4_B_CL, with user offsets.
87	IMAGE_GATHER4_LZ_O	GATHER4_LZ, with user offsets.
88	IMAGE_GATHER4_C_O	GATHER4_C, with user offsets.
89	IMAGE_GATHER4_C_CL_O	GATHER4_C_CL, with user offsets.
92	IMAGE_GATHER4_C_L_O	GATHER4_C_L, with user offsets.
93	IMAGE_GATHER4_C_B_O	GATHER4_B, with user offsets.
94	IMAGE_GATHER4_C_B_CL_O	GATHER4_B_CL, with user offsets.
95	IMAGE_GATHER4_C_LZ_O	GATHER4_C_LZ, with user offsets.
96	IMAGE_GET_LOD	<p>VDATA[0] = clampedLOD;  VDATA[1] = rawLOD.</p> <p>Return calculated LOD as two 32-bit floating point values.</p>
97	IMAGE_GATHER4H	Fetch 1 component per texel from 4x1 texels. DMASK selects which component to read (R,G,B,A) and must have only one bit set to 1.
128	IMAGE_MSAA_LOAD	Load up to 4 samples of 1 component from an MSAA resource with a user-specified fragment ID. No sampler.
162	IMAGE_SAMPLE_D_G16	SAMPLE_D with 16-bit floating point derivatives (gradients)
163	IMAGE_SAMPLE_D_CL_G16	SAMPLE_D_CL with 16-bit floating point derivatives (gradients)
170	IMAGE_SAMPLE_C_D_G16	SAMPLE_C_D with 16-bit floating point derivatives (gradients)
171	IMAGE_SAMPLE_C_D_CL_G16	SAMPLE_C_D_CL with 16-bit floating point derivatives (gradients)
178	IMAGE_SAMPLE_D_O_G16	SAMPLE_D_O with 16-bit floating point derivatives (gradients)
179	IMAGE_SAMPLE_D_CL_O_G16	SAMPLE_D_CL_O with 16-bit floating point derivatives (gradients)
186	IMAGE_SAMPLE_C_D_O_G16	SAMPLE_C_D_O with 16-bit floating point derivatives (gradients)
187	IMAGE_SAMPLE_C_D_CL_O_G16	SAMPLE_C_D_CL_O with 16-bit floating point derivatives (gradients)

Opcode	Name	Description
230	IMAGE_BVH_INTERSECT_RAY	<p>Intersection test on bound volume hierarchy nodes for ray tracing acceleration. 32-bit node pointer. No sampler.</p> <p>DATA:</p> <p>The destination VGPRs contain the results of intersection testing. The values returned here are different depending on the type of BVH node that was fetched.</p> <p>For box nodes the results contain the 4 pointers of the children boxes in intersection time sorted order.</p> <p>For triangle BVH nodes the results contain the intersection time and triangle ID of the triangle tested.</p> <p>ADDR:</p> <p>11 address VGPRs contain the ray data and BVH node pointer for the intersection test. The data is laid out as follows:</p> <pre> vgpr_a[0] = node_pointer (uint32) vgpr_a[1] = ray_extent (float32) vgpr_a[2] = ray_origin.x (float32) vgpr_a[3] = ray_origin.y (float32) vgpr_a[4] = ray_origin.z (float32) vgpr_a[5] = ray_dir.x (float32) vgpr_a[6] = ray_dir.y (float32) vgpr_a[7] = ray_dir.z (float32) vgpr_a[8] = ray_inv_dir.x (float32) vgpr_a[9] = ray_inv_dir.y (float32) vgpr_a[10]= ray_inv_dir.z (float32)                     </pre> <p>For performance and power optimization, the instruction can be encoded to use 16 bit floats for ray_dir and ray_inv_dir by setting A16 to 1. When the instruction is encoded with 16 bit addresses only 8 address VGPRs are used as follows:</p> <pre> vgpr_a[0] = node_pointer (uint32) vgpr_a[1] = ray_extent (float32) vgpr_a[2] = ray_origin.x (float32) vgpr_a[3] = ray_origin.y (float32) vgpr_a[4] = ray_origin.z (float32) vgpr_a[5] = {ray_dir.x,ray_dir.y}(2x float16) vgpr_a[6] = {ray_dir.z,ray_inv_dir.x}(2x float16) vgpr_a[7] = {ray_inv_dir.y,ray_inv_dir.z}(2x float16)                     </pre> <p>RSRC:</p> <p>The resource is the texture descriptor for the operation. The instruction must e encoded with r128=1.</p> <p>RESTRICTIONS:</p> <p>The image_bvh_intersect_ray and image_bvh64_intersect_ray opcode do not support all of</p>

Opcode	Name	Description
231	IMAGE_BVH64_INTERSECT_RAY	<p>Intersection test on bound volume hierarchy nodes for ray tracing acceleration. 64-bit node pointer. No sampler.</p> <p>This instruction allows support for very large BVHs (larger than 32 GBs) that may occur in workstation workloads. See IMAGE_BVH_INTERSECT_RAY for basic information including restrictions.</p> <p>ADDR:</p> <p>12 address VGPRs contain the ray data and BVH node pointer for the intersection test. The data is laid out as follows:</p> <pre> vgpr_a[0] = node_pointer[31:0] (first part of uint64) vgpr_a[1] = node_pointer[63:32] (second part of uint64) vgpr_a[2] = ray_extent (float32) vgpr_a[3] = ray_origin.x (float32) vgpr_a[4] = ray_origin.y (float32) vgpr_a[5] = ray_origin.z (float32) vgpr_a[6] = ray_dir.x (float32) vgpr_a[7] = ray_dir.y (float32) vgpr_a[8] = ray_dir.z (float32) vgpr_a[9] = ray_inv_dir.x (float32) vgpr_a[10] = ray_inv_dir.y (float32) vgpr_a[11] = ray_inv_dir.z (float32) </pre> <p>For performance and power optimization, the instruction can be encoded to use 16 bit floats for ray_dir and ray_inv_dir by setting A16 to 1. When the instruction is encoded with 16 bit addresses only 9 address VGPRs are used as follows:</p> <pre> vgpr_a[0] = node_pointer[31:0] (first part of uint64) vgpr_a[1] = node_pointer[63:32] (second part of uint64) vgpr_a[2] = ray_extent (float32) vgpr_a[3] = ray_origin.x (float32) vgpr_a[4] = ray_origin.y (float32) vgpr_a[5] = ray_origin.z (float32) vgpr_a[6] = {ray_dir.x, ray_dir.y} (2x float16) vgpr_a[7] = {ray_dir.z, ray_inv_dir.x} (2x float16) vgpr_a[8] = {ray_inv_dir.y, ray_inv_dir.z} (2x float16) </pre>

## 12.17. EXPORT Instructions

Transfer vertex position, vertex parameter, pixel color, or pixel depth information to the output buffer. Every pixel shader must do at least one export to a color, depth or NULL target with the VM bit set to 1. This communicates the pixel-valid mask to the color and depth buffers. Every pixel does only one of the above export types with the DONE bit set to 1. Vertex shaders must do one or more position exports, and at least one parameter export. The final position export must have the DONE bit set to 1.

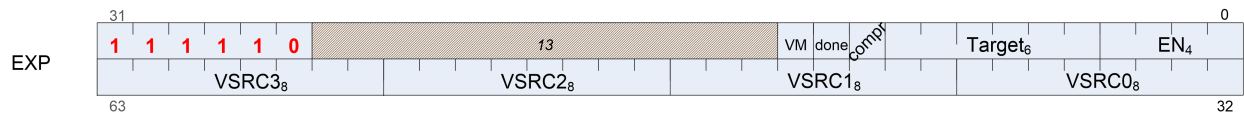

## 12.18. FLAT, Scratch and Global Instructions

The bitfield map of the FLAT format is:

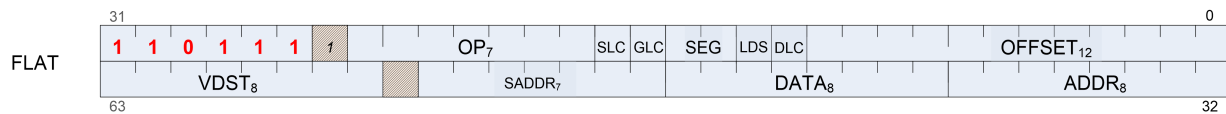

where:

- GLC = Global coherency.
- SLC = System level coherency.
- OP = Instruction Opcode.
- ADDR = Source of flat address VGPR.
- DATA = Source data.
- VDST = Destination VGPR.
- SADDR = SGPR holding address or offset
- SEG = Instruction type: Flat, Scratch, or Global
- LDS = Data is transferred between LDS and Memory, not VGPRs.
- OFFSET = Immediate address byte-offset.

### 12.18.1. Flat Instructions

Flat instructions look at the per-workitem address and determine for each work item if the target memory address is in global, private or scratch memory.

Opcode	Name	Description
8	FLAT_LOAD_UBYTE	Untyped buffer load unsigned byte (zero extend to VGPR destination).
9	FLAT_LOAD_SBYTE	Untyped buffer load signed byte (sign extend to VGPR destination).
10	FLAT_LOAD_USHORT	Untyped buffer load unsigned short (zero extend to VGPR destination).
11	FLAT_LOAD_SSHORT	Untyped buffer load signed short (sign extend to VGPR destination).
12	FLAT_LOAD_DWORD	Untyped buffer load dword.
13	FLAT_LOAD_DWORDX2	Untyped buffer load 2 dwords.
14	FLAT_LOAD_DWORDX4	Untyped buffer load 4 dwords.
15	FLAT_LOAD_DWORDX3	Untyped buffer load 3 dwords.
24	FLAT_STORE_BYTE	Untyped buffer store byte. Stores S0[7:0].



Opcode	Name	Description
25	FLAT_STORE_BYTE_D16_HI	Untyped buffer store byte. Stores S0[23:16].
26	FLAT_STORE_SHORT	Untyped buffer store short. Stores S0[15:0].
27	FLAT_STORE_SHORT_D16_HI	Untyped buffer store short. Stores S0[31:16].
28	FLAT_STORE_DWORD	Untyped buffer store dword.
29	FLAT_STORE_DWORDX2	Untyped buffer store 2 dwords.
30	FLAT_STORE_DWORDX4	Untyped buffer store 4 dwords.
31	FLAT_STORE_DWORDX3	Untyped buffer store 3 dwords.
32	FLAT_LOAD_UBYTE_D16	D0[15:0] = {8'h0, MEM[ADDR]}. Untyped buffer load unsigned byte.
33	FLAT_LOAD_UBYTE_D16_HI	D0[31:16] = {8'h0, MEM[ADDR]}. Untyped buffer load unsigned byte.
34	FLAT_LOAD_SBYTE_D16	D0[15:0] = signext(MEM[ADDR]). Untyped buffer load signed byte.
35	FLAT_LOAD_SBYTE_D16_HI	D0[31:16] = signext(MEM[ADDR]). Untyped buffer load signed byte.
36	FLAT_LOAD_SHORT_D16	D0[15:0] = MEM[ADDR]. Untyped buffer load short.
37	FLAT_LOAD_SHORT_D16_HI	D0[31:16] = MEM[ADDR]. Untyped buffer load short.
48	FLAT_ATOMIC_SWAP	// 32bit tmp = MEM[ADDR]; MEM[ADDR] = DATA; RETURN_DATA = tmp.
49	FLAT_ATOMIC_CMPSWAP	// 32bit tmp = MEM[ADDR]; src = DATA[0]; cmp = DATA[1]; MEM[ADDR] = (tmp == cmp) ? src : tmp; RETURN_DATA[0] = tmp.
50	FLAT_ATOMIC_ADD	// 32bit tmp = MEM[ADDR]; MEM[ADDR] += DATA; RETURN_DATA = tmp.
51	FLAT_ATOMIC_SUB	// 32bit tmp = MEM[ADDR]; MEM[ADDR] -= DATA; RETURN_DATA = tmp.
53	FLAT_ATOMIC_SMIN	// 32bit tmp = MEM[ADDR]; MEM[ADDR] = (DATA < tmp) ? DATA : tmp; // signed compare RETURN_DATA = tmp.

Opcode	Name	Description
54	FLAT_ATOMIC_UMIN	<pre>// 32bit tmp = MEM[ADDR]; MEM[ADDR] = (DATA &lt; tmp) ? DATA : tmp; // unsigned compare RETURN_DATA = tmp.</pre>
55	FLAT_ATOMIC_SMAX	<pre>// 32bit tmp = MEM[ADDR]; MEM[ADDR] = (DATA &gt; tmp) ? DATA : tmp; // signed compare RETURN_DATA = tmp.</pre>
56	FLAT_ATOMIC_UMAX	<pre>// 32bit tmp = MEM[ADDR]; MEM[ADDR] = (DATA &gt; tmp) ? DATA : tmp; // unsigned compare RETURN_DATA = tmp.</pre>
57	FLAT_ATOMIC_AND	<pre>// 32bit tmp = MEM[ADDR]; MEM[ADDR] &amp;= DATA; RETURN_DATA = tmp.</pre>
58	FLAT_ATOMIC_OR	<pre>// 32bit tmp = MEM[ADDR]; MEM[ADDR]  = DATA; RETURN_DATA = tmp.</pre>
59	FLAT_ATOMIC_XOR	<pre>// 32bit tmp = MEM[ADDR]; MEM[ADDR] ^= DATA; RETURN_DATA = tmp.</pre>
60	FLAT_ATOMIC_INC	<pre>// 32bit tmp = MEM[ADDR]; MEM[ADDR] = (tmp &gt;= DATA) ? 0 : tmp + 1; // unsigned compare RETURN_DATA = tmp.</pre>
61	FLAT_ATOMIC_DEC	<pre>// 32bit tmp = MEM[ADDR]; MEM[ADDR] = (tmp == 0    tmp &gt; DATA) ? DATA : tmp - 1; // unsigned compare RETURN_DATA = tmp.</pre>
62	FLAT_ATOMIC_FCMP_SWAP	<pre>// 32bit tmp = MEM[ADDR]; src = DATA[0]; cmp = DATA[1]; MEM[ADDR] = (tmp == cmp) ? src : tmp; RETURN_DATA[0] = tmp.</pre> <p>Floating-point compare swap (handles NaN/INF/denorm).</p>
63	FLAT_ATOMIC_FMIN	<pre>// 32bit tmp = MEM[ADDR]; src = DATA[0]; MEM[ADDR] = (src &lt; tmp) ? src : tmp; RETURN_DATA[0] = tmp.</pre> <p>Floating-point compare (handles NaN/INF/denorm).</p>

Opcode	Name	Description
64	FLAT_ATOMIC_FMAX	<pre>// 32bit tmp = MEM[ADDR]; src = DATA[0]; MEM[ADDR] = (src &gt; tmp) ? src : tmp; RETURN_DATA[0] = tmp.</pre> <p>Floating-point compare (handles NaN/INF/denorm).</p>
80	FLAT_ATOMIC_SWAP_X2	<pre>// 64bit tmp = MEM[ADDR]; MEM[ADDR] = DATA[0:1]; RETURN_DATA[0:1] = tmp.</pre>
81	FLAT_ATOMIC_CMPSWAP_X2	<pre>// 64bit tmp = MEM[ADDR]; src = DATA[0:1]; cmp = DATA[2:3]; MEM[ADDR] = (tmp == cmp) ? src : tmp; RETURN_DATA[0:1] = tmp.</pre>
82	FLAT_ATOMIC_ADD_X2	<pre>// 64bit tmp = MEM[ADDR]; MEM[ADDR] += DATA[0:1]; RETURN_DATA[0:1] = tmp.</pre>
83	FLAT_ATOMIC_SUB_X2	<pre>// 64bit tmp = MEM[ADDR]; MEM[ADDR] -= DATA[0:1]; RETURN_DATA[0:1] = tmp.</pre>
85	FLAT_ATOMIC_SMIN_X2	<pre>// 64bit tmp = MEM[ADDR]; MEM[ADDR] = (DATA[0:1] &lt; tmp) ? DATA[0:1] : tmp; // signed compare RETURN_DATA[0:1] = tmp.</pre>
86	FLAT_ATOMIC_UMIN_X2	<pre>// 64bit tmp = MEM[ADDR]; MEM[ADDR] = (DATA[0:1] &lt; tmp) ? DATA[0:1] : tmp; // unsigned compare RETURN_DATA[0:1] = tmp.</pre>
87	FLAT_ATOMIC_SMAX_X2	<pre>// 64bit tmp = MEM[ADDR]; MEM[ADDR] = (DATA[0:1] &gt; tmp) ? DATA[0:1] : tmp; // signed compare RETURN_DATA[0:1] = tmp.</pre>
88	FLAT_ATOMIC_UMAX_X2	<pre>// 64bit tmp = MEM[ADDR]; MEM[ADDR] = (DATA[0:1] &gt; tmp) ? DATA[0:1] : tmp; // unsigned compare RETURN_DATA[0:1] = tmp.</pre>
89	FLAT_ATOMIC_AND_X2	<pre>// 64bit tmp = MEM[ADDR]; MEM[ADDR] &amp;= DATA[0:1]; RETURN_DATA[0:1] = tmp.</pre>

Opcode	Name	Description
90	FLAT_ATOMIC_OR_X2	<pre>// 64bit tmp = MEM[ADDR]; MEM[ADDR]  = DATA[0:1]; RETURN_DATA[0:1] = tmp.</pre>
91	FLAT_ATOMIC_XOR_X2	<pre>// 64bit tmp = MEM[ADDR]; MEM[ADDR] ^= DATA[0:1]; RETURN_DATA[0:1] = tmp.</pre>
92	FLAT_ATOMIC_INC_X2	<pre>// 64bit tmp = MEM[ADDR]; MEM[ADDR] = (tmp &gt;= DATA[0:1]) ? 0 : tmp + 1; // unsigned compare RETURN_DATA[0:1] = tmp.</pre>
93	FLAT_ATOMIC_DEC_X2	<pre>// 64bit tmp = MEM[ADDR]; MEM[ADDR] = (tmp == 0    tmp &gt; DATA[0:1]) ? DATA[0:1] : tmp - 1; // unsigned compare RETURN_DATA[0:1] = tmp.</pre>
94	FLAT_ATOMIC_FCMP_SWAP_X2	<pre>// 64bit tmp = MEM[ADDR]; src = DATA[0]; cmp = DATA[1]; MEM[ADDR] = (tmp == cmp) ? src : tmp; RETURN_DATA[0] = tmp.</pre> <p>Floating-point compare swap (handles NaN/INF/denorm).</p>
95	FLAT_ATOMIC_FMIN_X2	<pre>// 64bit tmp = MEM[ADDR]; src = DATA[0]; MEM[ADDR] = (src &lt; tmp) ? src : tmp; RETURN_DATA[0] = tmp.</pre> <p>Floating-point compare (handles NaN/INF/denorm).</p>
96	FLAT_ATOMIC_FMAX_X2	<pre>// 64bit tmp = MEM[ADDR]; src = DATA[0]; MEM[ADDR] = (src &gt; tmp) ? src : tmp; RETURN_DATA[0] = tmp.</pre> <p>Floating-point compare (handles NaN/INF/denorm).</p>

## 12.18.2. Scratch Instructions

Scratch instructions are like Flat, but assume all workitem addresses fall in scratch (private) space.

Opcode	Name	Description
8	SCRATCH_LOAD_UBYTE	Untyped buffer load unsigned byte (zero extend to VGPR destination).

Opcode	Name	Description
9	SCRATCH_LOAD_SBYTE	Untyped buffer load signed byte (sign extend to VGPR destination).
10	SCRATCH_LOAD_USHORT	Untyped buffer load unsigned short (zero extend to VGPR destination).
11	SCRATCH_LOAD_SSHORT	Untyped buffer load signed short (sign extend to VGPR destination).
12	SCRATCH_LOAD_DWORD	Untyped buffer load dword.
13	SCRATCH_LOAD_DWORDX2	Untyped buffer load 2 dwords.
14	SCRATCH_LOAD_DWORDX4	Untyped buffer load 4 dwords.
15	SCRATCH_LOAD_DWORDX3	Untyped buffer load 3 dwords.
24	SCRATCH_STORE_BYTE	Untyped buffer store byte. Stores S0[7:0].
25	SCRATCH_STORE_BYTE_D16_HI	Untyped buffer store byte. Stores S0[23:16].
26	SCRATCH_STORE_SHORT	Untyped buffer store short. Stores S0[15:0].
27	SCRATCH_STORE_SHORT_D16_HI	Untyped buffer store short. Stores S0[31:16].
28	SCRATCH_STORE_DWORD	Untyped buffer store dword.
29	SCRATCH_STORE_DWORDX2	Untyped buffer store 2 dwords.
30	SCRATCH_STORE_DWORDX4	Untyped buffer store 4 dwords.
31	SCRATCH_STORE_DWORDX3	Untyped buffer store 3 dwords.
32	SCRATCH_LOAD_UBYTE_D16	D0[15:0] = {8'h0, MEM[ADDR]}. Untyped buffer load unsigned byte.
33	SCRATCH_LOAD_UBYTE_D16_HI	D0[31:16] = {8'h0, MEM[ADDR]}. Untyped buffer load unsigned byte.
34	SCRATCH_LOAD_SBYTE_D16	D0[15:0] = signext(MEM[ADDR]). Untyped buffer load signed byte.
35	SCRATCH_LOAD_SBYTE_D16_HI	D0[31:16] = signext(MEM[ADDR]). Untyped buffer load signed byte.
36	SCRATCH_LOAD_SHORT_D16	D0[15:0] = MEM[ADDR]. Untyped buffer load short.
37	SCRATCH_LOAD_SHORT_D16_HI	D0[31:16] = MEM[ADDR]. Untyped buffer load short.

### 12.18.3. Global Instructions

Global instructions are like Flat, but assume all workitem addresses fall in global memory space.

Opcode	Name	Description
8	GLOBAL_LOAD_UBYTE	Untyped buffer load unsigned byte (zero extend to VGPR destination).
9	GLOBAL_LOAD_SBYTE	Untyped buffer load signed byte (sign extend to VGPR destination).
10	GLOBAL_LOAD_USHORT	Untyped buffer load unsigned short (zero extend to VGPR destination).
11	GLOBAL_LOAD_SSHORT	Untyped buffer load signed short (sign extend to VGPR destination).
12	GLOBAL_LOAD_DWORD	Untyped buffer load dword.
13	GLOBAL_LOAD_DWORDX2	Untyped buffer load 2 dwords.
14	GLOBAL_LOAD_DWORDX4	Untyped buffer load 4 dwords.
15	GLOBAL_LOAD_DWORDX3	Untyped buffer load 3 dwords.
22	GLOBAL_LOAD_DWORD_ADDTID	Untyped buffer load dword. No VGPR address is supplied in this instruction. TID is added to the address as shown below:  memory_Addr = sgpr_addr(64)+ inst_offset(12) + tid*4
23	GLOBAL_STORE_DWORD_ADDTID	Untyped buffer store dword. No VGPR address is supplied in this instruction. TID is added to the address as shown below:  memory_Addr = sgpr_addr(64) + inst_offset(12) + tid*4
24	GLOBAL_STORE_BYTE	Untyped buffer store byte. Stores S0[7:0].
25	GLOBAL_STORE_BYTE_D16_HI	Untyped buffer store byte. Stores S0[23:16].
26	GLOBAL_STORE_SHORT	Untyped buffer store short. Stores S0[15:0].
27	GLOBAL_STORE_SHORT_D16_HI	Untyped buffer store short. Stores S0[31:16].
28	GLOBAL_STORE_DWORD	Untyped buffer store dword.
29	GLOBAL_STORE_DWORDX2	Untyped buffer store 2 dwords.
30	GLOBAL_STORE_DWORDX4	Untyped buffer store 4 dwords.
31	GLOBAL_STORE_DWORDX3	Untyped buffer store 3 dwords.
32	GLOBAL_LOAD_UBYTE_D16	D0[15:0] = {8'h0, MEM[ADDR]}.  Untyped buffer load unsigned byte.
33	GLOBAL_LOAD_UBYTE_D16_HI	D0[31:16] = {8'h0, MEM[ADDR]}.  Untyped buffer load unsigned byte.
34	GLOBAL_LOAD_SBYTE_D16	D0[15:0] = signext(MEM[ADDR]).  Untyped buffer load signed byte.
35	GLOBAL_LOAD_SBYTE_D16_HI	D0[31:16] = signext(MEM[ADDR]).  Untyped buffer load signed byte.

Opcode	Name	Description
36	GLOBAL_LOAD_SHORT_D16	D0[15:0] = MEM[ADDR]. Untyped buffer load short.
37	GLOBAL_LOAD_SHORT_D16_HI	D0[31:16] = MEM[ADDR]. Untyped buffer load short.
48	GLOBAL_ATOMIC_SWAP	// 32bit tmp = MEM[ADDR]; MEM[ADDR] = DATA; RETURN_DATA = tmp.
49	GLOBAL_ATOMIC_CMPSWAP	// 32bit tmp = MEM[ADDR]; src = DATA[0]; cmp = DATA[1]; MEM[ADDR] = (tmp == cmp) ? src : tmp; RETURN_DATA[0] = tmp.
50	GLOBAL_ATOMIC_ADD	// 32bit tmp = MEM[ADDR]; MEM[ADDR] += DATA; RETURN_DATA = tmp.
51	GLOBAL_ATOMIC_SUB	// 32bit tmp = MEM[ADDR]; MEM[ADDR] -= DATA; RETURN_DATA = tmp.
52	GLOBAL_ATOMIC_CSUB	// 32bit old_value = MEM[ADDR]; if old_value < DATA then new_value = 0; else new_value = old_value - DATA; endif; MEM[addr] = new_value; RETURN_DATA = old_value.
53	GLOBAL_ATOMIC_SMIN	// 32bit tmp = MEM[ADDR]; MEM[ADDR] = (DATA < tmp) ? DATA : tmp; // signed compare RETURN_DATA = tmp.
54	GLOBAL_ATOMIC_UMIN	// 32bit tmp = MEM[ADDR]; MEM[ADDR] = (DATA < tmp) ? DATA : tmp; // unsigned compare RETURN_DATA = tmp.
55	GLOBAL_ATOMIC_SMAX	// 32bit tmp = MEM[ADDR]; MEM[ADDR] = (DATA > tmp) ? DATA : tmp; // signed compare RETURN_DATA = tmp.
56	GLOBAL_ATOMIC_UMAX	// 32bit tmp = MEM[ADDR]; MEM[ADDR] = (DATA > tmp) ? DATA : tmp; // unsigned compare RETURN_DATA = tmp.

Opcode	Name	Description
57	GLOBAL_ATOMIC_AND	<pre>// 32bit tmp = MEM[ADDR]; MEM[ADDR] &amp;= DATA; RETURN_DATA = tmp.</pre>
58	GLOBAL_ATOMIC_OR	<pre>// 32bit tmp = MEM[ADDR]; MEM[ADDR]  = DATA; RETURN_DATA = tmp.</pre>
59	GLOBAL_ATOMIC_XOR	<pre>// 32bit tmp = MEM[ADDR]; MEM[ADDR] ^= DATA; RETURN_DATA = tmp.</pre>
60	GLOBAL_ATOMIC_INC	<pre>// 32bit tmp = MEM[ADDR]; MEM[ADDR] = (tmp &gt;= DATA) ? 0 : tmp + 1; // unsigned compare RETURN_DATA = tmp.</pre>
61	GLOBAL_ATOMIC_DEC	<pre>// 32bit tmp = MEM[ADDR]; MEM[ADDR] = (tmp == 0    tmp &gt; DATA) ? DATA : tmp - 1; // unsigned compare RETURN_DATA = tmp.</pre>
62	GLOBAL_ATOMIC_FCMP_SWAP	<pre>// 32bit tmp = MEM[ADDR]; src = DATA[0]; cmp = DATA[1]; MEM[ADDR] = (tmp == cmp) ? src : tmp; RETURN_DATA[0] = tmp.</pre> <p>Floating-point compare swap (handles NaN/INF/denorm).</p>
63	GLOBAL_ATOMIC_FMIN	<pre>// 32bit tmp = MEM[ADDR]; src = DATA[0]; MEM[ADDR] = (src &lt; tmp) ? src : tmp; RETURN_DATA[0] = tmp.</pre> <p>Floating-point compare (handles NaN/INF/denorm).</p>
64	GLOBAL_ATOMIC_FMAX	<pre>// 32bit tmp = MEM[ADDR]; src = DATA[0]; MEM[ADDR] = (src &gt; tmp) ? src : tmp; RETURN_DATA[0] = tmp.</pre> <p>Floating-point compare (handles NaN/INF/denorm).</p>
80	GLOBAL_ATOMIC_SWAP_X2	<pre>// 64bit tmp = MEM[ADDR]; MEM[ADDR] = DATA[0:1]; RETURN_DATA[0:1] = tmp.</pre>



Opcode	Name	Description
81	GLOBAL_ATOMIC_CMPSWAP_X2	<pre>// 64bit tmp = MEM[ADDR]; src = DATA[0:1]; cmp = DATA[2:3]; MEM[ADDR] = (tmp == cmp) ? src : tmp; RETURN_DATA[0:1] = tmp.</pre>
82	GLOBAL_ATOMIC_ADD_X2	<pre>// 64bit tmp = MEM[ADDR]; MEM[ADDR] += DATA[0:1]; RETURN_DATA[0:1] = tmp.</pre>
83	GLOBAL_ATOMIC_SUB_X2	<pre>// 64bit tmp = MEM[ADDR]; MEM[ADDR] -= DATA[0:1]; RETURN_DATA[0:1] = tmp.</pre>
85	GLOBAL_ATOMIC_SMIN_X2	<pre>// 64bit tmp = MEM[ADDR]; MEM[ADDR] = (DATA[0:1] &lt; tmp) ? DATA[0:1] : tmp; // signed compare RETURN_DATA[0:1] = tmp.</pre>
86	GLOBAL_ATOMIC_UMIN_X2	<pre>// 64bit tmp = MEM[ADDR]; MEM[ADDR] = (DATA[0:1] &lt; tmp) ? DATA[0:1] : tmp; // unsigned compare RETURN_DATA[0:1] = tmp.</pre>
87	GLOBAL_ATOMIC_SMAX_X2	<pre>// 64bit tmp = MEM[ADDR]; MEM[ADDR] = (DATA[0:1] &gt; tmp) ? DATA[0:1] : tmp; // signed compare RETURN_DATA[0:1] = tmp.</pre>
88	GLOBAL_ATOMIC_UMAX_X2	<pre>// 64bit tmp = MEM[ADDR]; MEM[ADDR] = (DATA[0:1] &gt; tmp) ? DATA[0:1] : tmp; // unsigned compare RETURN_DATA[0:1] = tmp.</pre>
89	GLOBAL_ATOMIC_AND_X2	<pre>// 64bit tmp = MEM[ADDR]; MEM[ADDR] &amp;= DATA[0:1]; RETURN_DATA[0:1] = tmp.</pre>
90	GLOBAL_ATOMIC_OR_X2	<pre>// 64bit tmp = MEM[ADDR]; MEM[ADDR]  = DATA[0:1]; RETURN_DATA[0:1] = tmp.</pre>
91	GLOBAL_ATOMIC_XOR_X2	<pre>// 64bit tmp = MEM[ADDR]; MEM[ADDR] ^= DATA[0:1]; RETURN_DATA[0:1] = tmp.</pre>

Opcode	Name	Description
92	GLOBAL_ATOMIC_INC_X2	<pre>// 64bit tmp = MEM[ADDR]; MEM[ADDR] = (tmp &gt;= DATA[0:1]) ? 0 : tmp + 1; // unsigned compare RETURN_DATA[0:1] = tmp.</pre>
93	GLOBAL_ATOMIC_DEC_X2	<pre>// 64bit tmp = MEM[ADDR]; MEM[ADDR] = (tmp == 0    tmp &gt; DATA[0:1]) ? DATA[0:1] : tmp - 1; // unsigned compare RETURN_DATA[0:1] = tmp.</pre>
94	GLOBAL_ATOMIC_FCMP_SWAP_X2	<pre>// 64bit tmp = MEM[ADDR]; src = DATA[0]; cmp = DATA[1]; MEM[ADDR] = (tmp == cmp) ? src : tmp; RETURN_DATA[0] = tmp.</pre> <p>Floating-point compare swap (handles NaN/INF/denorm).</p>
95	GLOBAL_ATOMIC_FMIN_X2	<pre>// 64bit tmp = MEM[ADDR]; src = DATA[0]; MEM[ADDR] = (src &lt; tmp) ? src : tmp; RETURN_DATA[0] = tmp.</pre> <p>Floating-point compare (handles NaN/INF/denorm).</p>
96	GLOBAL_ATOMIC_FMAX_X2	<pre>// 64bit tmp = MEM[ADDR]; src = DATA[0]; MEM[ADDR] = (src &gt; tmp) ? src : tmp; RETURN_DATA[0] = tmp.</pre> <p>Floating-point compare (handles NaN/INF/denorm).</p>

## 12.19. Instruction Limitations

### 12.19.1. DPP

The following instructions cannot use DPP:

- V\_FMAMK\_F32
- V\_FMAAK\_F32
- V\_FMAMK\_F16
- V\_FMAAK\_F16
- V\_READFIRSTLANE\_B32
- V\_CVT\_I32\_F64
- V\_CVT\_F64\_I32

- V\_CVT\_F32\_F64
- V\_CVT\_F64\_F32
- V\_CVT\_U32\_F64
- V\_CVT\_F64\_U32
- V\_TRUNC\_F64
- V\_CEIL\_F64
- V\_RNDNE\_F64
- V\_FLOOR\_F64
- V\_RCP\_F64
- V\_RSQ\_F64
- V\_SQRT\_F64
- V\_FREXP\_EXP\_I32\_F64
- V\_FREXP\_MANT\_F64
- V\_FRACT\_F64
- V\_CLREXCP
- V\_SWAP\_B32
- V\_CMP\_CLASS\_F64
- V\_CMPX\_CLASS\_F64
- V\_CMP\_\*\_F64
- V\_CMPX\_\*\_F64
- V\_CMP\_\*\_I64
- V\_CMP\_\*\_U64
- V\_CMPX\_\*\_I64
- V\_CMPX\_\*\_U64

### 12.19.2. SDWA

The following instructions cannot use SDWA:

- V\_FMAC\_F32
- V\_FMAMK\_F32
- V\_FMAAK\_F32
- V\_FMAC\_F16
- V\_FMAMK\_F16
- V\_FMAAK\_F16
- V\_READFIRSTLANE\_B32
- V\_CLREXCP
- V\_SWAP\_B32

## Chapter 13. Microcode Formats

This section specifies the microcode formats. The definitions can be used to simplify compilation by providing standard templates and enumeration names for the various instruction formats.

Endian Order - The RDNA architecture addresses memory and registers using littleendian byte-ordering and bit-ordering. Multi-byte values are stored with their least-significant (low-order) byte (LSB) at the lowest byte address, and they are illustrated with their LSB at the right side. Byte values are stored with their least-significant (low-order) bit (lsb) at the lowest bit address, and they are illustrated with their lsb at the right side.

The table below summarizes the microcode formats and their widths. The sections that follow provide details

Table 62. Summary of Microcode Formats

Microcode Formats	Reference	Width (bits)
<b>Scalar ALU and Control Formats</b>		
SOP2	<a href="#">SOP2</a>	32
SOP1	<a href="#">SOP1</a>	
SOPK	<a href="#">SOPK</a>	
SOPP	<a href="#">SOPP</a>	
SOPC	<a href="#">SOPC</a>	
<b>Scalar Memory Format</b>		
SMEM	<a href="#">SMEM</a>	64
<b>Vector ALU Format</b>		
VOP1	<a href="#">VOP1</a>	32
VOP2	<a href="#">VOP2</a>	32
VOPC	<a href="#">VOPC</a>	32
VOP3A	<a href="#">VOP3A</a>	64
VOP3B	<a href="#">VOP3B</a>	64
VOP3P	<a href="#">VOP3P</a>	64
DPP	<a href="#">DPP</a>	32
SDWA	<a href="#">VOP2</a>	32
<b>Vector Parameter Interpolation Format</b>		
VINTRP	<a href="#">VINTRP</a>	32
<b>LDS/GDS Format</b>		
DS	<a href="#">DS</a>	64
<b>Vector Memory Buffer Formats</b>		

Microcode Formats	Reference	Width (bits)
MTBUF	<a href="#">MTBUF</a>	64
MUBUF	<a href="#">MUBUF</a>	64
<b>Vector Memory Image Format</b>		
MIMG	<a href="#">MIMG</a>	64
<b>Export Format</b>		
EXP	<a href="#">EXP</a>	64
<b>Flat Formats</b>		
FLAT	<a href="#">FLAT</a>	64
GLOBAL	<a href="#">GLOBAL</a>	64
SCRATCH	<a href="#">SCRATCH</a>	64

The field-definition tables that accompany the descriptions in the sections below use the following notation.

- int(2) - A two-bit field that specifies an unsigned integer value.
- enum(7) - A seven-bit field that specifies an enumerated set of values (in this case, a set of up to 27 values). The number of valid values can be less than the maximum.

The default value of all fields is zero. Any bitfield not identified is assumed to be reserved.

### Instruction Suffixes

Most instructions include a suffix which indicates the data type the instruction handles. This suffix may also include a number which indicate the size of the data.

For example: "F32" indicates "32-bit floating point data", or "B16" is "16-bit binary data".

- B = binary
- F = floating point
- U = unsigned integer
- S = signed integer

When more than one data-type specifier occurs in an instruction, the last one is the result type and size, and the earlier one(s) is/are input data type and size.

## 13.1. Scalar ALU and Control Formats

### 13.1.1. SOP2

Scalar format with Two inputs, one output



**Format** SOP2

**Description** This is a scalar instruction with two inputs and one output. Can be followed by a 32-bit literal constant.

Table 63. SOP2 Fields

Field Name	Bits	Format or Description
SSRC0	[7:0]	Source 0. First operand for the instruction.
	0 - 105	SGPR0 to SGPR105: Scalar general-purpose registers.
	106	VCC_LO: vcc[31:0].
	107	VCC_HI: vcc[63:32].
	108-123	TTMP0 - TTMP15: Trap handler temporary register.
	124	M0. Memory register 0.
	125	NULL
	126	EXEC_LO: exec[31:0].
	127	EXEC_HI: exec[63:32].
	128	0.
	129-192	Signed integer 1 to 64.
	193-208	Signed integer -1 to -16.
	209-234	Reserved.
	235	SHARED_BASE (Memory Aperture definition).
	236	SHARED_LIMIT (Memory Aperture definition).
	237	PRIVATE_BASE (Memory Aperture definition).
	238	PRIVATE_LIMIT (Memory Aperture definition).
	239	POPS_EXITING_WAVE_ID .
	240	0.5.
	241	-0.5.
	242	1.0.
	243	-1.0.
	244	2.0.
	245	-2.0.
	246	4.0.
	247	-4.0.
	248	1/(2*PI).
249 - 250	Reserved.	
251	VCCZ.	
252	EXECZ.	
253	SCC.	
254	Reserved.	
255	Literal constant.	
SSRC1	[15:8]	Second scalar source operand. Same codes as SSRC0, above.

Field Name	Bits	Format or Description
SDST	[22:16]	Scalar destination. Same codes as SSR0, above except only codes 0-127 are valid.
OP	[29:23]	See Opcode table below.
ENCODING	[31:30]	10

Table 64. SOP2 Opcodes

Opcode #	Name	Opcode #	Name
0	S_ADD_U32	28	S_XNOR_B32
1	S_SUB_U32	29	S_XNOR_B64
2	S_ADD_I32	30	S_LSHL_B32
3	S_SUB_I32	31	S_LSHL_B64
4	S_ADDC_U32	32	S_LSHR_B32
5	S_SUBB_U32	33	S_LSHR_B64
6	S_MIN_I32	34	S_ASHR_I32
7	S_MIN_U32	35	S_ASHR_I64
8	S_MAX_I32	36	S_BFM_B32
9	S_MAX_U32	37	S_BFM_B64
10	S_CSELECT_B32	38	S_MUL_I32
11	S_CSELECT_B64	39	S_BFE_U32
14	S_AND_B32	40	S_BFE_I32
15	S_AND_B64	41	S_BFE_U64
16	S_OR_B32	42	S_BFE_I64
17	S_OR_B64	44	S_ABSDIFF_I32
18	S_XOR_B32	46	S_LSHL1_ADD_U32
19	S_XOR_B64	47	S_LSHL2_ADD_U32
20	S_ANDN2_B32	48	S_LSHL3_ADD_U32
21	S_ANDN2_B64	49	S_LSHL4_ADD_U32
22	S_ORN2_B32	50	S_PACK_LL_B32_B16
23	S_ORN2_B64	51	S_PACK_LH_B32_B16
24	S_NAND_B32	52	S_PACK_HH_B32_B16
25	S_NAND_B64	53	S_MUL_HI_U32
26	S_NOR_B32	54	S_MUL_HI_I32
27	S_NOR_B64		

### 13.1.2. SOPK

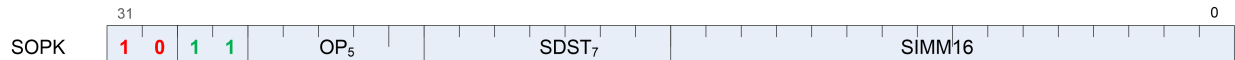

**Format** SOPK

**Description** This is a scalar instruction with one 16-bit signed immediate (SIMM16) input and a single destination. Instructions which take 2 inputs use the destination as the second input.

Table 65. SOPK Fields

Field Name	Bits	Format or Description
SIMM16	[15:0]	Signed immediate 16-bit value.
SDST	[22:16] 0 - 105 106 107 108-123 124 125 126 127	Scalar destination, and can provide second source operand. SGPR0 to SGPR105: Scalar general-purpose registers. VCC_LO: vcc[31:0]. VCC_HI: vcc[63:32]. TTMP0 - TTMP15: Trap handler temporary register. M0. Memory register 0. NULL EXEC_LO: exec[31:0]. EXEC_HI: exec[63:32].
OP	[27:23]	See Opcode table below.
ENCODING	[31:28]	1011

Table 66. SOPK Opcodes

Opcode #	Name	Opcode #	Name
0	S_MOVK_I32	14	S_CMPK_LE_U32
1	S_VERSION	15	S_ADDK_I32
2	S_CMOVK_I32	16	S_MULK_I32
3	S_CMPK_EQ_I32	18	S_GETREG_B32
4	S_CMPK_LG_I32	19	S_SETREG_B32
5	S_CMPK_GT_I32	21	S_SETREG_IMM32_B32
6	S_CMPK_GE_I32	22	S_CALL_B64
7	S_CMPK_LT_I32	23	S_WAITCNT_VSCNT
8	S_CMPK_LE_I32	24	S_WAITCNT_VMCNT
9	S_CMPK_EQ_U32	25	S_WAITCNT_EXPCNT
10	S_CMPK_LG_U32	26	S_WAITCNT_LGKMCNT
11	S_CMPK_GT_U32	27	S_SUBVECTOR_LOOP_BEGIN



Opcode #	Name	Opcode #	Name
12	S_CMPK_GE_U32	28	S_SUBVECTOR_LOOP_END
13	S_CMPK_LT_U32		

### 13.1.3. SOP1

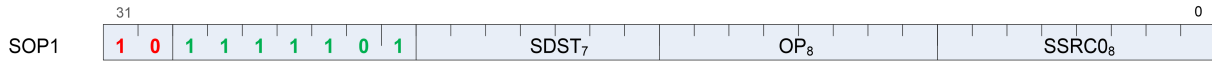

**Format** SOP1

**Description** This is a scalar instruction with two inputs and one output. Can be followed by a 32-bit literal constant.

*Table 67. SOP1 Fields*

Field Name	Bits	Format or Description
SSRC0	[7:0]	Source 0. First operand for the instruction.
	0 - 105	SGPR0 to SGPR105: Scalar general-purpose registers.
	106	VCC_LO: vcc[31:0].
	107	VCC_HI: vcc[63:32].
	108-123	TTMP0 - TTMP15: Trap handler temporary register.
	124	M0. Memory register 0.
	125	NULL
	126	EXEC_LO: exec[31:0].
	127	EXEC_HI: exec[63:32].
	128	0.
	129-192	Signed integer 1 to 64.
	193-208	Signed integer -1 to -16.
	209-234	Reserved.
	235	SHARED_BASE (Memory Aperture definition).
	236	SHARED_LIMIT (Memory Aperture definition).
	237	PRIVATE_BASE (Memory Aperture definition).
	238	PRIVATE_LIMIT (Memory Aperture definition).
	239	POPS_EXITING_WAVE_ID .
	240	0.5.
	241	-0.5.
	242	1.0.
	243	-1.0.
	244	2.0.
	245	-2.0.
	246	4.0.
	247	-4.0.
	248	1/(2*PI).
	249 - 250	Reserved.
	251	VCCZ.
	252	EXECZ.
253	SCC.	
254	Reserved.	
255	Literal constant.	
OP	[15:8]	See Opcode table below.
SDST	[22:16]	Scalar destination. Same codes as SSRC0, above except only codes 0-127 are valid.
ENCODING	[31:23]	10_1111101

Table 68. SOP1 Opcodes

Opcode #	Name	Opcode #	Name
3	S_MOV_B32	37	S_OR_SAVEEXEC_B64
4	S_MOV_B64	38	S_XOR_SAVEEXEC_B64
5	S_CMOV_B32	39	S_ANDN2_SAVEEXEC_B64
6	S_CMOV_B64	40	S_ORN2_SAVEEXEC_B64
7	S_NOT_B32	41	S_NAND_SAVEEXEC_B64
8	S_NOT_B64	42	S_NOR_SAVEEXEC_B64

Opcode #	Name	Opcode #	Name
9	S_WQM_B32	43	S_XNOR_SAVEEXEC_B64
10	S_WQM_B64	44	S_QUADMASK_B32
11	S_BREV_B32	45	S_QUADMASK_B64
12	S_BREV_B64	46	S_MOVRELS_B32
13	S_BCNT0_I32_B32	47	S_MOVRELS_B64
14	S_BCNT0_I32_B64	48	S_MOVRELD_B32
15	S_BCNT1_I32_B32	49	S_MOVRELD_B64
16	S_BCNT1_I32_B64	52	S_ABS_I32
17	S_FF0_I32_B32	55	S_ANDN1_SAVEEXEC_B64
18	S_FF0_I32_B64	56	S_ORN1_SAVEEXEC_B64
19	S_FF1_I32_B32	57	S_ANDN1_WREXEC_B64
20	S_FF1_I32_B64	58	S_ANDN2_WREXEC_B64
21	S_FLBIT_I32_B32	59	S_BITREPLICATE_B64_B32
22	S_FLBIT_I32_B64	60	S_AND_SAVEEXEC_B32
23	S_FLBIT_I32	61	S_OR_SAVEEXEC_B32
24	S_FLBIT_I32_I64	62	S_XOR_SAVEEXEC_B32
25	S_SEXT_I32_I8	63	S_ANDN2_SAVEEXEC_B32
26	S_SEXT_I32_I16	64	S_ORN2_SAVEEXEC_B32
27	S_BITSET0_B32	65	S_NAND_SAVEEXEC_B32
28	S_BITSET0_B64	66	S_NOR_SAVEEXEC_B32
29	S_BITSET1_B32	67	S_XNOR_SAVEEXEC_B32
30	S_BITSET1_B64	68	S_ANDN1_SAVEEXEC_B32
31	S_GETPC_B64	69	S_ORN1_SAVEEXEC_B32
32	S_SETPC_B64	70	S_ANDN1_WREXEC_B32
33	S_SWAPPC_B64	71	S_ANDN2_WREXEC_B32
34	S_RFE_B64	73	S_MOVRELSD_2_B32
36	S_AND_SAVEEXEC_B64		

### 13.1.4. SOPC



**Format** SOPC

**Description** This is a scalar instruction with two inputs which are compared and produce SCC as a result. Can be followed by a 32-bit literal constant.

Table 69. SOPC Fields

Field Name	Bits	Format or Description
SSRC0	[7:0]	Source 0. First operand for the instruction.
	0 - 105	SGPR0 to SGPR105: Scalar general-purpose registers.
	106	VCC_LO: vcc[31:0].
	107	VCC_HI: vcc[63:32].
	108-123	TTMP0 - TTMP15: Trap handler temporary register.
	124	M0. Memory register 0.
	125	NULL
	126	EXEC_LO: exec[31:0].
	127	EXEC_HI: exec[63:32].
	128	0.
	129-192	Signed integer 1 to 64.
	193-208	Signed integer -1 to -16.
	209-234	Reserved.
	235	SHARED_BASE (Memory Aperture definition).
	236	SHARED_LIMIT (Memory Aperture definition).
	237	PRIVATE_BASE (Memory Aperture definition).
	238	PRIVATE_LIMIT (Memory Aperture definition).
	239	POPS_EXITING_WAVE_ID .
	240	0.5.
	241	-0.5.
	242	1.0.
	243	-1.0.
	244	2.0.
	245	-2.0.
	246	4.0.
	247	-4.0.
	248	1/(2*PI).
	249 - 250	Reserved.
	251	VCCZ.
	252	EXECZ.
	253	SCC.
254	Reserved.	
255	Literal constant.	
SSRC1	[15:8]	Second scalar source operand. Same codes as SSRC0, above.
OP	[22:16]	See Opcode table below.
ENCODING	[31:23]	10_111110

Table 70. SOPC Opcodes

Opcode #	Name	Opcode #	Name
0	S_CMP_EQ_I32	9	S_CMP_GE_U32
1	S_CMP_LG_I32	10	S_CMP_LT_U32

Opcode #	Name	Opcode #	Name
2	S_CMP_GT_I32	11	S_CMP_LE_U32
3	S_CMP_GE_I32	12	S_BITCMP0_B32
4	S_CMP_LT_I32	13	S_BITCMP1_B32
5	S_CMP_LE_I32	14	S_BITCMP0_B64
6	S_CMP_EQ_U32	15	S_BITCMP1_B64
7	S_CMP_LG_U32	18	S_CMP_EQ_U64
8	S_CMP_GT_U32	19	S_CMP_LG_U64

### 13.1.5. SOPP



**Format** SOPP

**Description** This is a scalar instruction with one 16-bit signed immediate (SIMM16) input.

Table 71. SOPP Fields

Field Name	Bits	Format or Description
SIMM16	[15:0]	Signed immediate 16-bit value.
OP	[22:16]	See Opcode table below.
ENCODING	[31:23]	10_1111111

Table 72. SOPP Opcodes

Opcode #	Name	Opcode #	Name
0	S_NOP	18	S_TRAP
1	S_ENDPGM	19	S_ICACHE_INV
2	S_BRANCH	20	S_INCPERFLEVEL
3	S_WAKEUP	21	S_DECPERFLEVEL
4	S_CBRANCH_SCC0	22	S_TTRACEDATA
5	S_CBRANCH_SCC1	23	S_CBRANCH_CDBGSYS
6	S_CBRANCH_VCCZ	24	S_CBRANCH_CDBGUSER
7	S_CBRANCH_VCCNZ	25	S_CBRANCH_CDBGSYS_OR_USER
8	S_CBRANCH_EXECZ	26	S_CBRANCH_CDBGSYS_AND_USER
9	S_CBRANCH_EXECNZ	27	S_ENDPGM_SAVED

Opcode #	Name	Opcode #	Name
10	S_BARRIER	30	S_ENDPGM_ORDERED_PS_DONE
11	S_SETKILL	31	S_CODE_END
12	S_WAITCNT	32	S_INST_PREFETCH
13	S_SETHALT	33	S_CLAUSE
14	S_SLEEP	35	S_WAITCNT_DEPCTR
15	S_SETPRIO	36	S_ROUND_MODE
16	S_SENDMSG	37	S_DENORM_MODE
17	S_SENDMSGHALT	40	S_TTRACEDATA_IMM

## 13.2. Scalar Memory Format

### 13.2.1. SMEM

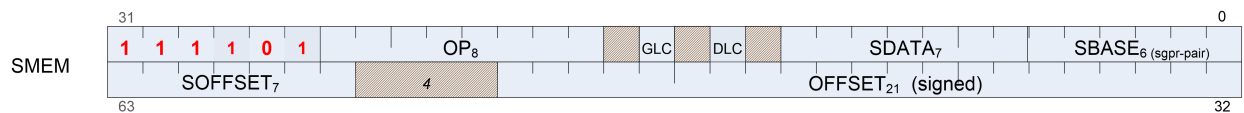

**Format** SMEM

**Description** Scalar Memory data load/store

Table 73. SMEM Fields

Field Name	Bits	Format or Description
SBASE	[5:0]	SGPR-pair which provides base address or SGPR-quad which provides V#. (LSB of SGPR address is omitted).
SDATA	[12:6]	SGPR which provides write data or accepts return data.
DLC	[14]	Device level coherent.
GLC	[16]	Globally memory Coherent. Force bypass of L1 cache, or for atomics, cause pre-op value to be returned.
OP	[25:18]	See Opcode table below.
ENCODING	[31:26]	111101
OFFSET	[52:32]	An immediate signed byte offset. Signed offsets only work with S_LOAD/STORE.
SOFFSET	[63:57]	SGPR which supplies an unsigned byte offset. Disabled if set to NULL.

Table 74. SMEM Opcodes

Opcode #	Name	Opcode #	Name
0	S_LOAD_DWORD	11	S_BUFFER_LOAD_DWORDX8
1	S_LOAD_DWORDX2	12	S_BUFFER_LOAD_DWORDX16
2	S_LOAD_DWORDX4	31	S_GL1_INV
3	S_LOAD_DWORDX8	32	S_DCACHE_INV
4	S_LOAD_DWORDX16	36	S_MEMTIME
8	S_BUFFER_LOAD_DWORD	37	S_MEMREALTIME
9	S_BUFFER_LOAD_DWORDX2	38	S_ATC_PROBE
10	S_BUFFER_LOAD_DWORDX4	39	S_ATC_PROBE_BUFFER

## 13.3. Vector ALU Formats

### 13.3.1. VOP2



**Format** VOP2

**Description** Vector ALU format with two operands

Table 75. VOP2 Fields

Field Name	Bits	Format or Description
SRC0	[8:0]	Source 0. First operand for the instruction.
	0 - 105	SGPR0 to SGPR105: Scalar general-purpose registers.
	106	VCC_LO: vcc[31:0].
	107	VCC_HI: vcc[63:32].
	108-123	TTMP0 - TTMP15: Trap handler temporary register.
	124	M0. Memory register 0.
	125	NULL
	126	EXEC_LO: exec[31:0].
	127	EXEC_HI: exec[63:32].
	128	0.
	129-192	Signed integer 1 to 64.
	193-208	Signed integer -1 to -16.
	209-232	Reserved.
	233	DPP8
	234	DPP8FI
	235	SHARED_BASE (Memory Aperture definition).
	236	SHARED_LIMIT (Memory Aperture definition).
	237	PRIVATE_BASE (Memory Aperture definition).
	238	PRIVATE_LIMIT (Memory Aperture definition).
	239	POPS_EXITING_WAVE_ID .
	240	0.5.
	241	-0.5.
	242	1.0.
	243	-1.0.
	244	2.0.
	245	-2.0.
	246	4.0.
	247	-4.0.
	248	1/(2*PI).
	249	SDWA
	250	DPP16
	251	VCCZ.
	252	EXECZ.
	253	SCC.
254	Reserved.	
255	Literal constant.	
256 - 511	VGPR 0 - 255	
VSRC1	[16:9]	VGPR which provides the second operand.
VDST	[24:17]	Destination VGPR.
OP	[30:25]	See Opcode table below.
ENCODING	[31]	0

Table 76. VOP2 Opcodes

Opcode #	Name	Opcode #	Name
1	V_CNDMASK_B32	29	V_XOR_B32
2	V_DOT2C_F32_F16	30	V_XNOR_B32
3	V_ADD_F32	37	V_ADD_NC_U32
4	V_SUB_F32	38	V_SUB_NC_U32



Opcode #	Name	Opcode #	Name
5	V_SUBREV_F32	39	V_SUBREV_NC_U32
6	V_FMAC_LEGACY_F32	40	V_ADD_CO_CI_U32
7	V_MUL_LEGACY_F32	41	V_SUB_CO_CI_U32
8	V_MUL_F32	42	V_SUBREV_CO_CI_U32
9	V_MUL_I32_I24	43	V_FMAC_F32
10	V_MUL_HI_I32_I24	44	V_FMAMK_F32
11	V_MUL_U32_U24	45	V_FMAAK_F32
12	V_MUL_HI_U32_U24	47	V_CVT_PKRTZ_F16_F32
13	V_DOT4C_I32_I8	50	V_ADD_F16
15	V_MIN_F32	51	V_SUB_F16
16	V_MAX_F32	52	V_SUBREV_F16
17	V_MIN_I32	53	V_MUL_F16
18	V_MAX_I32	54	V_FMAC_F16
19	V_MIN_U32	55	V_FMAMK_F16
20	V_MAX_U32	56	V_FMAAK_F16
22	V_LSHRREV_B32	57	V_MAX_F16
24	V_ASHRREV_I32	58	V_MIN_F16
26	V_LSHLREV_B32	59	V_LDEXP_F16
27	V_AND_B32	60	V_PK_FMAC_F16
28	V_OR_B32		

### 13.3.2. VOP1

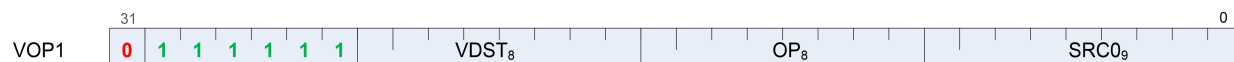

**Format** VOP1

**Description** Vector ALU format with one operand

Table 77. VOP1 Fields

Field Name	Bits	Format or Description
SRC0	[8:0]	Source 0. First operand for the instruction.
	0 - 105	SGPR0 to SGPR105: Scalar general-purpose registers.
	106	VCC_LO: vcc[31:0].
	107	VCC_HI: vcc[63:32].
	108-123	TTMP0 - TTMP15: Trap handler temporary register.
	124	M0. Memory register 0.
	125	NULL
	126	EXEC_LO: exec[31:0].
	127	EXEC_HI: exec[63:32].
	128	0.
	129-192	Signed integer 1 to 64.
	193-208	Signed integer -1 to -16.
	209-232	Reserved.
	233	DPP8
	234	DPP8FI
	235	SHARED_BASE (Memory Aperture definition).
	236	SHARED_LIMIT (Memory Aperture definition).
	237	PRIVATE_BASE (Memory Aperture definition).
	238	PRIVATE_LIMIT (Memory Aperture definition).
	239	POPS_EXITING_WAVE_ID .
	240	0.5.
	241	-0.5.
	242	1.0.
	243	-1.0.
	244	2.0.
	245	-2.0.
	246	4.0.
	247	-4.0.
	248	1/(2*PI).
	249	SDWA
	250	DPP16
	251	VCCZ.
	252	EXECZ.
	253	SCC.
	254	Reserved.
	255	Literal constant.
	256 - 511	VGPR 0 - 255
	OP	[16:9]
VDST	[24:17]	Destination VGPR.
ENCODING	[31:25]	0_11111

Table 78. VOP1 Opcodes

Opcode #	Name	Opcode #	Name
0	V_NOP	53	V_SIN_F32
1	V_MOV_B32	54	V_COS_F32
2	V_READFIRSTLANE_B32	55	V_NOT_B32
3	V_CVT_I32_F64	56	V_BFREV_B32
4	V_CVT_F64_I32	57	V_FFBH_U32

Opcode #	Name	Opcode #	Name
5	V_CVT_F32_I32	58	V_FFBL_B32
6	V_CVT_F32_U32	59	V_FFBLH_I32
7	V_CVT_U32_F32	60	V_FREXP_EXP_I32_F64
8	V_CVT_I32_F32	61	V_FREXP_MANT_F64
10	V_CVT_F16_F32	62	V_FRACT_F64
11	V_CVT_F32_F16	63	V_FREXP_EXP_I32_F32
12	V_CVT_RPI_I32_F32	64	V_FREXP_MANT_F32
13	V_CVT_FLR_I32_F32	65	V_CLREXCP
14	V_CVT_OFF_F32_I4	66	V_MOVRELD_B32
15	V_CVT_F32_F64	67	V_MOVRELS_B32
16	V_CVT_F64_F32	68	V_MOVRELSD_B32
17	V_CVT_F32_UBYTE0	72	V_MOVRELSD_2_B32
18	V_CVT_F32_UBYTE1	80	V_CVT_F16_U16
19	V_CVT_F32_UBYTE2	81	V_CVT_F16_I16
20	V_CVT_F32_UBYTE3	82	V_CVT_U16_F16
21	V_CVT_U32_F64	83	V_CVT_I16_F16
22	V_CVT_F64_U32	84	V_RCP_F16
23	V_TRUNC_F64	85	V_SQRT_F16
24	V_CEIL_F64	86	V_RSQ_F16
25	V_RNDNE_F64	87	V_LOG_F16
26	V_FLOOR_F64	88	V_EXP_F16
27	V_PIPEFLUSH	89	V_FREXP_MANT_F16
32	V_FRACT_F32	90	V_FREXP_EXP_I16_F16
33	V_TRUNC_F32	91	V_FLOOR_F16
34	V_CEIL_F32	92	V_CEIL_F16
35	V_RNDNE_F32	93	V_TRUNC_F16
36	V_FLOOR_F32	94	V_RNDNE_F16
37	V_EXP_F32	95	V_FRACT_F16
39	V_LOG_F32	96	V_SIN_F16
42	V_RCP_F32	97	V_COS_F16
43	V_RCP_IFLAG_F32	98	V_SAT_PK_U8_I16
46	V_RSQ_F32	99	V_CVT_NORM_I16_F16
47	V_RCP_F64	100	V_CVT_NORM_U16_F16
49	V_RSQ_F64	101	V_SWAP_B32

Opcode #	Name	Opcode #	Name
51	V_SQRT_F32	104	V_SWAPREL_B32
52	V_SQRT_F64		

### 13.3.3. VOPC



**Format** VOPC

**Description** Vector instruction taking two inputs and producing a comparison result. Can be followed by a 32-bit literal constant. Vector Comparison operations are divided into three groups:

- those which can use any one of 16 comparison operations,
- those which can use any one of 8, and
- those which have only a single comparison operation.

The final opcode number is determined by adding the base for the opcode family plus the offset from the compare op. Compare instructions write a result to VCC (for VOPC) or an SGPR (for VOP3). Additionally, every compare instruction has a variant that writes to the EXEC mask instead of VCC or SGPR. The destination of the compare result is VCC or EXEC when encoded using the VOPC format, and can be an arbitrary SGPR when only encoded in the VOP3 format.

#### Comparison Operations

Table 79. Comparison Operations

Compare Operation	Opcode Offset	Description
Sixteen Compare Operations (OP16)		
F	0	D.u = 0
LT	1	D.u = (S0 < S1)
EQ	2	D.u = (S0 == S1)
LE	3	D.u = (S0 <= S1)
GT	4	D.u = (S0 > S1)
LG	5	D.u = (S0 <> S1)
GE	6	D.u = (S0 >= S1)
O	7	D.u = (!isNaN(S0) && !isNaN(S1))
U	8	D.u = (!isNaN(S0)    !isNaN(S1))

Compare Operation	Opcode Offset	Description
NGE	9	$D.u = !(S0 \geq S1)$
NLG	10	$D.u = !(S0 <> S1)$
NGT	11	$D.u = !(S0 > S1)$
NLE	12	$D.u = !(S0 \leq S1)$
NEQ	13	$D.u = !(S0 == S1)$
NLT	14	$D.u = !(S0 < S1)$
TRU	15	$D.u = 1$
Eight Compare Operations (OP8)		
F	0	$D.u = 0$
LT	1	$D.u = (S0 < S1)$
EQ	2	$D.u = (S0 == S1)$
LE	3	$D.u = (S0 \leq S1)$
GT	4	$D.u = (S0 > S1)$
LG	5	$D.u = (S0 <> S1)$
GE	6	$D.u = (S0 \geq S1)$
TRU	7	$D.u = 1$

Table 80. VOPC Fields

Field Name	Bits	Format or Description
SRC0	[8:0]	Source 0. First operand for the instruction.
	0 - 105	SGPR0 to SGPR105: Scalar general-purpose registers.
	106	VCC_LO: vcc[31:0].
	107	VCC_HI: vcc[63:32].
	108-123	TTMP0 - TTMP15: Trap handler temporary register.
	124	M0. Memory register 0.
	125	NULL
	126	EXEC_LO: exec[31:0].
	127	EXEC_HI: exec[63:32].
	128	0.
	129-192	Signed integer 1 to 64.
	193-208	Signed integer -1 to -16.
	209-232	Reserved.
	233	DPP8
	234	DPP8FI
	235	SHARED_BASE (Memory Aperture definition).
	236	SHARED_LIMIT (Memory Aperture definition).
	237	PRIVATE_BASE (Memory Aperture definition).
	238	PRIVATE_LIMIT (Memory Aperture definition).
	239	POPS_EXITING_WAVE_ID .
	240	0.5.
	241	-0.5.
	242	1.0.
	243	-1.0.
	244	2.0.
	245	-2.0.
	246	4.0.
	247	-4.0.
	248	1/(2*PI).
	249	SDWA
	250	DPP16
	251	VCCZ.
	252	EXECZ.
	253	SCC.
254	Reserved.	
255	Literal constant.	
256 - 511	VGPR 0 - 255	
VSRC1	[16:9]	VGPR which provides the second operand.
OP	[24:17]	See Opcode table below.
ENCODING	[31:25]	0_111110

Table 81. VOPC Opcodes

Opcode #	Name	Opcode #	Name
0	V_CMP_F_F32	159	V_CMPX_CLASS_F16
1	V_CMP_LT_F32	160	V_CMP_F_I64
2	V_CMP_EQ_F32	161	V_CMP_LT_I64
3	V_CMP_LE_F32	162	V_CMP_EQ_I64
4	V_CMP_GT_F32	163	V_CMP_LE_I64

Opcode #	Name	Opcode #	Name
5	V_CMP_LG_F32	164	V_CMP_GT_I64
6	V_CMP_GE_F32	165	V_CMP_NE_I64
7	V_CMP_O_F32	166	V_CMP_GE_I64
8	V_CMP_U_F32	167	V_CMP_T_I64
9	V_CMP_NGE_F32	168	V_CMP_CLASS_F64
10	V_CMP_NLG_F32	169	V_CMP_LT_U16
11	V_CMP_NGT_F32	170	V_CMP_EQ_U16
12	V_CMP_NLE_F32	171	V_CMP_LE_U16
13	V_CMP_NEQ_F32	172	V_CMP_GT_U16
14	V_CMP_NLT_F32	173	V_CMP_NE_U16
15	V_CMP_TRU_F32	174	V_CMP_GE_U16
16	V_CMPX_F_F32	176	V_CMPX_F_I64
17	V_CMPX_LT_F32	177	V_CMPX_LT_I64
18	V_CMPX_EQ_F32	178	V_CMPX_EQ_I64
19	V_CMPX_LE_F32	179	V_CMPX_LE_I64
20	V_CMPX_GT_F32	180	V_CMPX_GT_I64
21	V_CMPX_LG_F32	181	V_CMPX_NE_I64
22	V_CMPX_GE_F32	182	V_CMPX_GE_I64
23	V_CMPX_O_F32	183	V_CMPX_T_I64
24	V_CMPX_U_F32	184	V_CMPX_CLASS_F64
25	V_CMPX_NGE_F32	185	V_CMPX_LT_U16
26	V_CMPX_NLG_F32	186	V_CMPX_EQ_U16
27	V_CMPX_NGT_F32	187	V_CMPX_LE_U16
28	V_CMPX_NLE_F32	188	V_CMPX_GT_U16
29	V_CMPX_NEQ_F32	189	V_CMPX_NE_U16
30	V_CMPX_NLT_F32	190	V_CMPX_GE_U16
31	V_CMPX_TRU_F32	192	V_CMP_F_U32
32	V_CMP_F_F64	193	V_CMP_LT_U32
33	V_CMP_LT_F64	194	V_CMP_EQ_U32
34	V_CMP_EQ_F64	195	V_CMP_LE_U32
35	V_CMP_LE_F64	196	V_CMP_GT_U32
36	V_CMP_GT_F64	197	V_CMP_NE_U32
37	V_CMP_LG_F64	198	V_CMP_GE_U32
38	V_CMP_GE_F64	199	V_CMP_T_U32

Opcode #	Name	Opcode #	Name
39	V_CMP_O_F64	200	V_CMP_F_F16
40	V_CMP_U_F64	201	V_CMP_LT_F16
41	V_CMP_NGE_F64	202	V_CMP_EQ_F16
42	V_CMP_NLG_F64	203	V_CMP_LE_F16
43	V_CMP_NGT_F64	204	V_CMP_GT_F16
44	V_CMP_NLE_F64	205	V_CMP_LG_F16
45	V_CMP_NEQ_F64	206	V_CMP_GE_F16
46	V_CMP_NLT_F64	207	V_CMP_O_F16
47	V_CMP_TRU_F64	208	V_CMPX_F_U32
48	V_CMPX_F_F64	209	V_CMPX_LT_U32
49	V_CMPX_LT_F64	210	V_CMPX_EQ_U32
50	V_CMPX_EQ_F64	211	V_CMPX_LE_U32
51	V_CMPX_LE_F64	212	V_CMPX_GT_U32
52	V_CMPX_GT_F64	213	V_CMPX_NE_U32
53	V_CMPX_LG_F64	214	V_CMPX_GE_U32
54	V_CMPX_GE_F64	215	V_CMPX_T_U32
55	V_CMPX_O_F64	216	V_CMPX_F_F16
56	V_CMPX_U_F64	217	V_CMPX_LT_F16
57	V_CMPX_NGE_F64	218	V_CMPX_EQ_F16
58	V_CMPX_NLG_F64	219	V_CMPX_LE_F16
59	V_CMPX_NGT_F64	220	V_CMPX_GT_F16
60	V_CMPX_NLE_F64	221	V_CMPX_LG_F16
61	V_CMPX_NEQ_F64	222	V_CMPX_GE_F16
62	V_CMPX_NLT_F64	223	V_CMPX_O_F16
63	V_CMPX_TRU_F64	224	V_CMP_F_U64
128	V_CMP_F_I32	225	V_CMP_LT_U64
129	V_CMP_LT_I32	226	V_CMP_EQ_U64
130	V_CMP_EQ_I32	227	V_CMP_LE_U64
131	V_CMP_LE_I32	228	V_CMP_GT_U64
132	V_CMP_GT_I32	229	V_CMP_NE_U64
133	V_CMP_NE_I32	230	V_CMP_GE_U64
134	V_CMP_GE_I32	231	V_CMP_T_U64
135	V_CMP_T_I32	232	V_CMP_U_F16
136	V_CMP_CLASS_F32	233	V_CMP_NGE_F16



Opcode #	Name	Opcode #	Name
137	V_CMP_LT_I16	234	V_CMP_NLG_F16
138	V_CMP_EQ_I16	235	V_CMP_NGT_F16
139	V_CMP_LE_I16	236	V_CMP_NLE_F16
140	V_CMP_GT_I16	237	V_CMP_NEQ_F16
141	V_CMP_NE_I16	238	V_CMP_NLT_F16
142	V_CMP_GE_I16	239	V_CMP_TRU_F16
143	V_CMP_CLASS_F16	240	V_CMPX_F_U64
144	V_CMPX_F_I32	241	V_CMPX_LT_U64
145	V_CMPX_LT_I32	242	V_CMPX_EQ_U64
146	V_CMPX_EQ_I32	243	V_CMPX_LE_U64
147	V_CMPX_LE_I32	244	V_CMPX_GT_U64
148	V_CMPX_GT_I32	245	V_CMPX_NE_U64
149	V_CMPX_NE_I32	246	V_CMPX_GE_U64
150	V_CMPX_GE_I32	247	V_CMPX_T_U64
151	V_CMPX_T_I32	248	V_CMPX_U_F16
152	V_CMPX_CLASS_F32	249	V_CMPX_NGE_F16
153	V_CMPX_LT_I16	250	V_CMPX_NLG_F16
154	V_CMPX_EQ_I16	251	V_CMPX_NGT_F16
155	V_CMPX_LE_I16	252	V_CMPX_NLE_F16
156	V_CMPX_GT_I16	253	V_CMPX_NEQ_F16
157	V_CMPX_NE_I16	254	V_CMPX_NLT_F16
158	V_CMPX_GE_I16	255	V_CMPX_TRU_F16

### 13.3.4. VOP3A

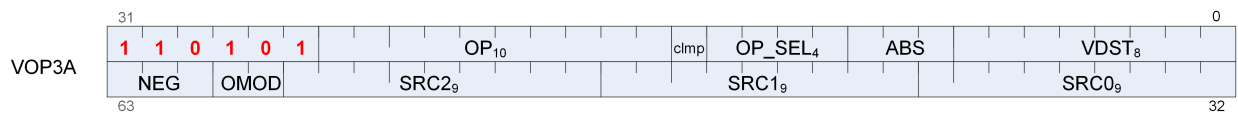

**Format**            VOP3A

**Description**    Vector ALU format with three operands

*Table 82. VOP3A Fields*

Field Name	Bits	Format or Description
VDST	[7:0]	Destination VGPR
ABS	[10:8]	Absolute value of input. [8] = src0, [9] = src1, [10] = src2
OPSEL	[14:11]	Operand select for 16-bit data. 0 = select low half, 1 = select high half. [11] = src0, [12] = src1, [13] = src2, [14] = dest.
CLMP	[15]	Clamp output
OP	[25:16]	Opcode. See next table.
ENCODING	[31:26]	110101
SRC0	[40:32] 0 - 105 106 107 108-123 124 125 126 127 128 129-192 193-208 209-232 233 234 235 236 237 238 239 240 241 242 243 244 245 246 247 248 249 250 251 252 253 254 255 256 - 511	Source 0. First operand for the instruction. SGPR0 to SGPR105: Scalar general-purpose registers. VCC_LO: vcc[31:0]. VCC_HI: vcc[63:32]. TTMP0 - TTMP15: Trap handler temporary register. M0. Memory register 0. NULL EXEC_LO: exec[31:0]. EXEC_HI: exec[63:32]. 0. Signed integer 1 to 64. Signed integer -1 to -16. Reserved. DPP8 DPP8FI SHARED_BASE (Memory Aperture definition). SHARED_LIMIT (Memory Aperture definition). PRIVATE_BASE (Memory Aperture definition). PRIVATE_LIMIT (Memory Aperture definition). POPS_EXITING_WAVE_ID . 0.5. -0.5. 1.0. -1.0. 2.0. -2.0. 4.0. -4.0. 1/(2*PI). SDWA DPP16 VCCZ. EXECZ. SCC. Reserved. Literal constant. VGPR 0 - 255
SRC1	[49:41]	Second input operand. Same options as SRC0.
SRC2	[58:50]	Third input operand. Same options as SRC0.
OMOD	[60:59]	Output Modifier: 0=none, 1=*2, 2=*4, 3=div-2
NEG	[63:61]	Negate input. [61] = src0, [62] = src1, [63] = src2

Table 83. VOP3A Opcodes

Opcode #	Name	Opcode #	Name
320	V_FMA_LEGACY_F32	775	V_LSHRREV_B16
322	V_MAD_I32_I24	776	V_ASHRREV_I16
323	V_MAD_U32_U24	777	V_MAX_U16
324	V_CUBEID_F32	778	V_MAX_I16
325	V_CUBESC_F32	779	V_MIN_U16
326	V_CUBETC_F32	780	V_MIN_I16
327	V_CUBEMA_F32	781	V_ADD_NC_I16
328	V_BFE_U32	782	V_SUB_NC_I16
329	V_BFE_I32	785	V_PACK_B32_F16
330	V_BFI_B32	786	V_CVT_PKNORM_I16_F16
331	V_FMA_F32	787	V_CVT_PKNORM_U16_F16
332	V_FMA_F64	788	V_LSHLREV_B16
333	V_LERP_U8	832	V_MAD_U16
334	V_ALIGNBIT_B32	834	V_INTERP_P1LL_F16
335	V_ALIGNBYTE_B32	835	V_INTERP_P1LV_F16
336	V_MULLIT_F32	836	V_PERM_B32
337	V_MIN3_F32	837	V_XAD_U32
338	V_MIN3_I32	838	V_LSHL_ADD_U32
339	V_MIN3_U32	839	V_ADD_LSHL_U32
340	V_MAX3_F32	843	V_FMA_F16
341	V_MAX3_I32	849	V_MIN3_F16
342	V_MAX3_U32	850	V_MIN3_I16
343	V_MED3_F32	851	V_MIN3_U16
344	V_MED3_I32	852	V_MAX3_F16
345	V_MED3_U32	853	V_MAX3_I16
346	V_SAD_U8	854	V_MAX3_U16
347	V_SAD_HI_U8	855	V_MED3_F16
348	V_SAD_U16	856	V_MED3_I16
349	V_SAD_U32	857	V_MED3_U16
350	V_CVT_PK_U8_F32	858	V_INTERP_P2_F16
351	V_DIV_FIXUP_F32	862	V_MAD_I16
352	V_DIV_FIXUP_F64	863	V_DIV_FIXUP_F16
356	V_ADD_F64	864	V_READLANE_B32

Opcode #	Name	Opcode #	Name
357	V_MUL_F64	865	V_WRITELANE_B32
358	V_MIN_F64	866	V_LDEXP_F32
359	V_MAX_F64	867	V_BFM_B32
360	V_LDEXP_F64	868	V_BCNT_U32_B32
361	V_MUL_LO_U32	869	V_MBCNT_LO_U32_B32
362	V_MUL_HI_U32	870	V_MBCNT_HI_U32_B32
364	V_MUL_HI_I32	872	V_CVT_PKNORM_I16_F32
367	V_DIV_FMAS_F32	873	V_CVT_PKNORM_U16_F32
368	V_DIV_FMAS_F64	874	V_CVT_PK_U16_U32
369	V_MSAD_U8	875	V_CVT_PK_I16_I32
370	V_QSAD_PK_U16_U8	877	V_ADD3_U32
371	V_MQSAD_PK_U16_U8	879	V_LSHL_OR_B32
372	V_TRIG_PREOP_F64	881	V_AND_OR_B32
373	V_MQSAD_U32_U8	882	V_OR3_B32
376	V_XOR3_B32	883	V_MAD_U32_U16
767	V_LSHLREV_B64	885	V_MAD_I32_I16
768	V_LSHRREV_B64	886	V_SUB_NC_I32
769	V_ASHRREV_I64	887	V_PERMLANE16_B32
771	V_ADD_NC_U16	888	V_PERMLANEX16_B32
772	V_SUB_NC_U16	895	V_ADD_NC_I32
773	V_MUL_LO_U16		

### 13.3.5. VOP3B

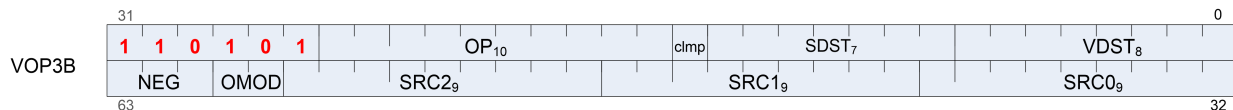

**Format** VOP3B

**Description** Vector ALU format with three operands and a scalar result. This encoding is used only for a few opcodes.

This encoding allows specifying a unique scalar destination, and is used only for the opcodes listed below. All other opcodes use VOP3A.

- V\_ADD\_CO\_U32
- V\_SUB\_CO\_U32
- V\_SUBREV\_CO\_U32
- V\_ADDC\_CO\_U32
- V\_SUBB\_CO\_U32
- V\_SUBBREV\_CO\_U32
- V\_DIV\_SCALE\_F32
- V\_DIV\_SCALE\_F64
- V\_MAD\_U64\_U32
- V\_MAD\_I64\_I32

Table 84. VOP3B Fields

Field Name	Bits	Format or Description
VDST	[7:0]	Destination VGPR
SDST	[14:8]	Scalar destination
CLMP	[15]	Clamp result
OP	[25:16]	Opcode. see next table.
ENCODING	[31:26]	110101

Field Name	Bits	Format or Description	
SRC0	[40:32]	Source 0. First operand for the instruction.	
	0 - 105	SGPR0 to SGPR105: Scalar general-purpose registers.	
	106	VCC_LO: vcc[31:0].	
	107	VCC_HI: vcc[63:32].	
	108-123	TTMP0 - TTMP15: Trap handler temporary register.	
	124	M0. Memory register 0.	
	125	NULL	
	126	EXEC_LO: exec[31:0].	
	127	EXEC_HI: exec[63:32].	
	128	0.	
	129-192	Signed integer 1 to 64.	
	193-208	Signed integer -1 to -16.	
	209-232	Reserved.	
	233	DPP8	
	234	DPP8FI	
	235	SHARED_BASE (Memory Aperture definition).	
	236	SHARED_LIMIT (Memory Aperture definition).	
	237	PRIVATE_BASE (Memory Aperture definition).	
	238	PRIVATE_LIMIT (Memory Aperture definition).	
	239	POPS_EXITING_WAVE_ID .	
	240	0.5.	
	241	-0.5.	
	242	1.0.	
	243	-1.0.	
	244	2.0.	
	245	-2.0.	
	246	4.0.	
	247	-4.0.	
	248	1/(2*PI).	
	249	SDWA	
	250	DPP16	
	251	VCCZ.	
	252	EXECZ.	
	253	SCC.	
	254	Reserved.	
	255	Literal constant.	
	256 - 511	VGPR 0 - 255	
	SRC1	[49:41]	Second input operand. Same options as SRC0.
	SRC2	[58:50]	Third input operand. Same options as SRC0.
	OMOD	[60:59]	Output Modifier: 0=none, 1=*2, 2=*4, 3=div-2
	NEG	[63:61]	Negate input. [61] = src0, [62] = src1, [63] = src2

Table 85. VOP3B Opcodes

Opcode #	Name	Opcode #	Name
365	V_DIV_SCALE_F32	783	V_ADD_CO_U32
366	V_DIV_SCALE_F64	784	V_SUB_CO_U32
374	V_MAD_U64_U32	793	V_SUBREV_CO_U32
375	V_MAD_I64_I32		

### 13.3.6. VOP3P

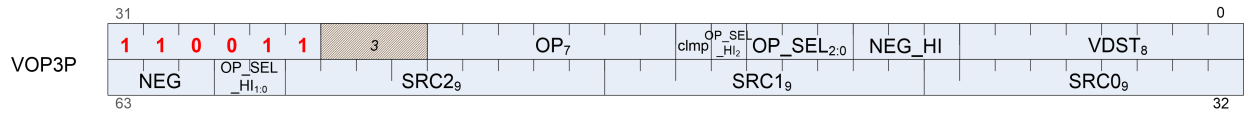

**Format** VOP3P

**Description** Vector ALU format taking one, two or three pairs of 16 bit inputs and producing two 16-bit outputs (packed into 1 dword).

Table 86. VOP3P Fields

Field Name	Bits	Format or Description
VDST	[7:0]	Destination VGPR
NEG_HI	[10:8]	Negate sources 0,1,2 of the high 16-bits.
OPSEL	[13:11]	Select low or high for low sources 0=[11], 1=[12], 2=[13].
OPSEL_HI2	[14]	Select low or high for high sources 0=[14], 1=[60], 2=[59].
CLMP	[15]	1 = clamp result.
OP	[22:16]	Opcode. see next table.
ENCODING	[31:26]	110011

Field Name	Bits	Format or Description
SRC0	[40:32]	Source 0. First operand for the instruction.
	0 - 105	SGPR0 to SGPR105: Scalar general-purpose registers.
	106	VCC_LO: vcc[31:0].
	107	VCC_HI: vcc[63:32].
	108-123	TTMP0 - TTMP15: Trap handler temporary register.
	124	M0. Memory register 0.
	125	NULL
	126	EXEC_LO: exec[31:0].
	127	EXEC_HI: exec[63:32].
	128	0.
	129-192	Signed integer 1 to 64.
	193-208	Signed integer -1 to -16.
	209-232	Reserved.
	233	DPP8
	234	DPP8FI
	235	SHARED_BASE (Memory Aperture definition).
	236	SHARED_LIMIT (Memory Aperture definition).
	237	PRIVATE_BASE (Memory Aperture definition).
	238	PRIVATE_LIMIT (Memory Aperture definition).
	239	POPS_EXITING_WAVE_ID .
	240	0.5.
	241	-0.5.
	242	1.0.
	243	-1.0.
	244	2.0.
	245	-2.0.
	246	4.0.
	247	-4.0.
	248	1/(2*PI).
	249	SDWA
	250	DPP16
	251	VCCZ.
	252	EXECZ.
	253	SCC.
	254	Reserved.
	255	Literal constant.
256 - 511	VGPR 0 - 255	
SRC1	[49:41]	Second input operand. Same options as SRC0.
SRC2	[58:50]	Third input operand. Same options as SRC0.
OPSEL_HI	[60:59]	See OP_SEL_HI2.
NEG	[63:61]	Negate input for low 16-bits of sources. [61] = src0, [62] = src1, [63] = src2

Table 87. VOP3P Opcodes

Opcode #	Name	Opcode #	Name
0	V_PK_MAD_I16	15	V_PK_ADD_F16
1	V_PK_MUL_LO_U16	16	V_PK_MUL_F16
2	V_PK_ADD_I16	17	V_PK_MIN_F16
3	V_PK_SUB_I16	18	V_PK_MAX_F16



Opcode #	Name	Opcode #	Name
4	V_PK_LSHLREV_B16	19	V_DOT2_F32_F16
5	V_PK_LSHRREV_B16	20	V_DOT2_I32_I16
6	V_PK_ASHRREV_I16	21	V_DOT2_U32_U16
7	V_PK_MAX_I16	22	V_DOT4_I32_I8
8	V_PK_MIN_I16	23	V_DOT4_U32_U8
9	V_PK_MAD_U16	24	V_DOT8_I32_I4
10	V_PK_ADD_U16	25	V_DOT8_U32_U4
11	V_PK_SUB_U16	32	V_FMA_MIX_F32
12	V_PK_MAX_U16	33	V_FMA_MIXLO_F16
13	V_PK_MIN_U16	34	V_FMA_MIXHI_F16
14	V_PK_FMA_F16		

### 13.3.7. SDWA

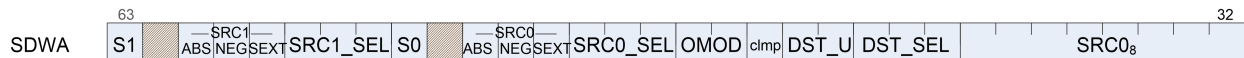

**Format** SDWA

**Description** Sub-Dword Addressing. This is a second dword which can follow VOP1 or VOP2 instructions (in place of a literal constant) to control selection of sub-dword (8-bit and 16-bit) operands. Use of SDWA is indicated by assigning the SRC0 field to SDWA, and then the actual VGPR used as source-zero is determined in SDWA instruction word.

Table 88. SDWA Fields

Field Name	Bits	Format or Description
SRC0	[39:32]	Real SRC0 operand (VGPR).
DST_SEL	[42:40]	Select the data destination: 0 = data[7:0] 1 = data[15:8] 2 = data[23:16] 3 = data[31:24] 4 = data[15:0] 5 = data[31:16] 6 = data[31:0] 7 = reserved

Field Name	Bits	Format or Description
DST_U	[44:43]	Destination format: what do with the bits in the VGPR that are not selected by DST_SEL: 0 = pad with zeros + 1 = sign extend upper / zero lower 2 = preserve (don't modify) 3 = reserved
CLMP	[45]	1 = clamp result
OMOD	[47:46]	Output modifiers (see VOP3). [46] = low half, [47] = high half
SRC0_SEL	[50:48]	Source 0 select. Same options as DST_SEL.
SRC0_SEXT	[51]	Sign extend modifier for source 0.
SRC0_NEG	[52]	1 = negate source 0.
SRC0_ABS	[53]	1 = Absolute value of source 0.
S0	[55]	0 = source 0 is VGPR, 1 = is SGPR.
SRC1_SEL	[58:56]	Same options as SRC0_SEL.
SRC1_SEXT	[59]	Sign extend modifier for source 1.
SRC1_NEG	[60]	1 = negate source 1.
SRC1_ABS	[61]	1 = Absolute value of source 1.
S1	[63]	0 = source 1 is VGPR, 1 = is SGPR.

### 13.3.8. SDWAB

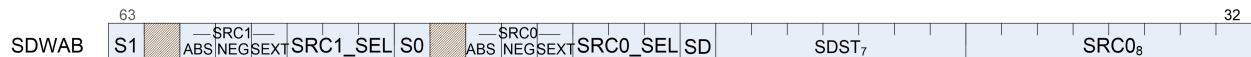

**Format** SDWAB

**Description** Sub-Dword Addressing. This is a second dword which can follow VOPC instructions (in place of a literal constant) to control selection of sub-dword (8-bit and 16-bit) operands. Use of SDWA is indicated by assigning the SRC0 field to SDWA, and then the actual VGPR used as source-zero is determined in SDWA instruction word. This version has a scalar destination.

Table 89. SDWAB Fields

Field Name	Bits	Format or Description
SRC0	[39:32]	Real SRC0 operand (VGPR).
SDST	[46:40]	Scalar GPR destination.
SD	[47]	Scalar destination type: 0 = VCC, 1 = normal SGPR.
SRC0_SEL	[50:48]	Source 0 select. Same options as DST_SEL.

Field Name	Bits	Format or Description
SRC0_SEXT	[51]	Sign extend modifier for source 0.
SRC0_NEG	[52]	1 = negate source 0.
SRC0_ABS	[53]	1 = Absolute value of source 0.
S0	[55]	0 = source 0 is VGPR, 1 = is SGPR.
SRC1_SEL	[58:56]	Same options as SRC0_SEL.
SRC1_SEXT	[59]	Sign extend modifier for source 1.
SRC1_NEG	[60]	1 = negate source 1.
SRC1_ABS	[61]	1 = Absolute value of source 1.
S1	[63]	0 = source 1 is VGPR, 1 = is SGPR.

### 13.3.9. DPP16



**Format** DPP16

**Description** Data Parallel Primitives over 16 lanes. This is a second dword which can follow VOP1, VOP2 or VOPC instructions (in place of a literal constant) to control selection of data from other lanes.

Table 90. DPP16 Fields

Field Name	Bits	Format or Description
SRC0	[39:32]	Real SRC0 operand (VGPR).
DPP_CTRL	[48:40]	See next table: "DPP_CTRL Enumeration"
FI	[50]	Fetch invalid data: 0 = read zero for any inactive lanes; 1 = read VGPRs even for invalid lanes.
BC	[51]	Bounds Control: 0 = do not write when source is out of range, 1 = write.
SRC0_NEG	[52]	1 = negate source 0.
SRC0_ABS	[53]	1 = Absolute value of source 0.
SRC1_NEG	[54]	1 = negate source 1.
SRC1_ABS	[55]	1 = Absolute value of source 1.

Field Name	Bits	Format or Description
BANK_MASK	[59:56]	Bank Mask Applies to the VGPR destination write only, does not impact the thread mask when fetching source VGPR data. 27==0: lanes[12:15, 28:31, 44:47, 60:63] are disabled 26==0: lanes[8:11, 24:27, 40:43, 56:59] are disabled 25==0: lanes[4:7, 20:23, 36:39, 52:55] are disabled 24==0: lanes[0:3, 16:19, 32:35, 48:51] are disabled Notice: the term "bank" here is not the same as was used for the VGPR bank.
ROW_MASK	[63:60]	Row Mask Applies to the VGPR destination write only, does not impact the thread mask when fetching source VGPR data. 31==0: lanes[63:48] are disabled (wave 64 only) 30==0: lanes[47:32] are disabled (wave 64 only) 29==0: lanes[31:16] are disabled 28==0: lanes[15:0] are disabled

Table 91. DPP\_CTRL Enumeration

DPP_Cntl Enumeration	Hex Value	Function	Description
DPP_QUAD_PERM*	000-0FF	$\text{pix}[n].\text{srca} = \text{pix}[(n \& 0x3c) + \text{dpp\_cntl}[n\%4*2+1 : n\%4*2]].\text{srca}$	Permute of four threads.
DPP_UNUSED	100	Undefined	Reserved.
DPP_ROW_SL*	101-10F	if $((n \& 0xf) < (16 - \text{cntl}[3:0]))$ $\text{pix}[n].\text{srca} = \text{pix}[n + \text{cntl}[3:0]].\text{srca}$ else use bound_cntl	Row shift left by 1-15 threads.
DPP_ROW_SR*	111-11F	if $((n \& 0xf) \geq \text{cntl}[3:0])$ $\text{pix}[n].\text{srca} = \text{pix}[n - \text{cntl}[3:0]].\text{srca}$ else use bound_cntl	Row shift right by 1-15 threads.
DPP_ROW_RR*	121-12F	if $((n \& 0xf) \geq \text{cntl}[3:0])$ $\text{pix}[n].\text{srca} = \text{pix}[n - \text{cntl}[3:0]].\text{srca}$ else $\text{pix}[n].\text{srca} = \text{pix}[n + 16 - \text{cntl}[3:0]].\text{srca}$	Row rotate right by 1-15 threads.
DPP_ROW_MIRROR*	140	$\text{pix}[n].\text{srca} = \text{pix}[15 - (n \& f)].\text{srca}$	Mirror threads within row.
DPP_ROW_HALF_MIRROR*	141	$\text{pix}[n].\text{srca} = \text{pix}[7 - (n \& 7)].\text{srca}$	Mirror threads within row (8 threads).

### 13.3.10. DPP8



**Format** DPP8

**Description** Data Parallel Primitives over 8 lanes. This is a second dword which can follow VOP1, VOP2 or VOPC instructions (in place of a literal constant) to control selection of data from other lanes.

Table 92. DPP8 Fields

Field Name	Bits	Format or Description
SRC0	[39:32]	Real SRC0 operand (VGPR).
LANE_SEL0	42:40	Which lane to read for 1st output lane per 8-lane group
LANE_SEL1	45:43	Which lane to read for 2nd output lane per 8-lane group
LANE_SEL2	48:46	Which lane to read for 3rd output lane per 8-lane group
LANE_SEL3	51:49	Which lane to read for 4th output lane per 8-lane group
LANE_SEL4	54:52	Which lane to read for 5th output lane per 8-lane group
LANE_SEL5	57:55	Which lane to read for 6th output lane per 8-lane group
LANE_SEL6	60:58	Which lane to read for 7th output lane per 8-lane group
LANE_SEL7	63:61	Which lane to read for 8th output lane per 8-lane group

## 13.4. Vector Parameter Interpolation Format

### 13.4.1. VINTRP



**Format** VINTRP

**Description** Vector Parameter Interpolation.  
 These opcodes perform parameter interpolation using vertex data in pixel shaders.

Table 93. VINTRP Fields

Field Name	Bits	Format or Description
VSRC	[7:0]	SRC0 operand (VGPR).
ATTR_CHAN	[9:8]	Attribute channel: 0=X, 1=Y, 2=Z, 3=W
ATTR	[15:10]	Attribute number: 0 - 32.
OP	[17:16]	Opcode: 0: v_interp_p1_f32 : VDST = P10 * VSRC + P0 1: v_interp_p2_f32: VDST = P20 * VSRC + VDST 2: v_interp_mov_f32: VDST = (P0, P10 or P20 selected by VSRC[1:0])
VDST	[25:18]	Destination VGPR
ENCODING	[31:26]	110010



User must set VSRC to be different from VDST.

## 13.5. LDS and GDS format

### 13.5.1. DS

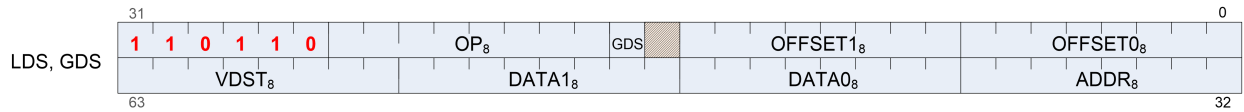

**Format** LDS and GDS

**Description** Local and Global Data Sharing instructions

Table 94. DS Fields

Field Name	Bits	Format or Description
OFFSET0	[7:0]	First address offset
OFFSET1	[15:8]	Second address offset. For some opcodes this is concatenated with OFFSET0.
GDS	[16]	1=GDS, 0=LDS operation.
OP	[24:17]	See Opcode table below.
ENCODING	[31:26]	110110
ADDR	[39:32]	VGPR which supplies the address.
DATA0	[47:40]	First data VGPR.
DATA1	[55:48]	Second data VGPR.
VDST	[63:56]	Destination VGPR when results returned to VGPRs.

Table 95. DS Opcodes

Opcode #	Name	Opcode #	Name
0	DS_ADD_U32	64	DS_ADD_U64
1	DS_SUB_U32	65	DS_SUB_U64
2	DS_RSUB_U32	66	DS_RSUB_U64
3	DS_INC_U32	67	DS_INC_U64
4	DS_DEC_U32	68	DS_DEC_U64
5	DS_MIN_I32	69	DS_MIN_I64
6	DS_MAX_I32	70	DS_MAX_I64
7	DS_MIN_U32	71	DS_MIN_U64
8	DS_MAX_U32	72	DS_MAX_U64
9	DS_AND_B32	73	DS_AND_B64
10	DS_OR_B32	74	DS_OR_B64

Opcode #	Name	Opcode #	Name
11	DS_XOR_B32	75	DS_XOR_B64
12	DS_MSKOR_B32	76	DS_MSKOR_B64
13	DS_WRITE_B32	77	DS_WRITE_B64
14	DS_WRITE2_B32	78	DS_WRITE2_B64
15	DS_WRITE2ST64_B32	79	DS_WRITE2ST64_B64
16	DS_CMPST_B32	80	DS_CMPST_B64
17	DS_CMPST_F32	81	DS_CMPST_F64
18	DS_MIN_F32	82	DS_MIN_F64
19	DS_MAX_F32	83	DS_MAX_F64
20	DS_NOP	85	DS_ADD_RTN_F32
21	DS_ADD_F32	96	DS_ADD_RTN_U64
24	DS_GWS_SEMA_RELEASE_ALL	97	DS_SUB_RTN_U64
25	DS_GWS_INIT	98	DS_RSUB_RTN_U64
26	DS_GWS_SEMA_V	99	DS_INC_RTN_U64
27	DS_GWS_SEMA_BR	100	DS_DEC_RTN_U64
28	DS_GWS_SEMA_P	101	DS_MIN_RTN_I64
29	DS_GWS_BARRIER	102	DS_MAX_RTN_I64
30	DS_WRITE_B8	103	DS_MIN_RTN_U64
31	DS_WRITE_B16	104	DS_MAX_RTN_U64
32	DS_ADD_RTN_U32	105	DS_AND_RTN_B64
33	DS_SUB_RTN_U32	106	DS_OR_RTN_B64
34	DS_RSUB_RTN_U32	107	DS_XOR_RTN_B64
35	DS_INC_RTN_U32	108	DS_MSKOR_RTN_B64
36	DS_DEC_RTN_U32	109	DS_WRXCHG_RTN_B64
37	DS_MIN_RTN_I32	110	DS_WRXCHG2_RTN_B64
38	DS_MAX_RTN_I32	111	DS_WRXCHG2ST64_RTN_B64
39	DS_MIN_RTN_U32	112	DS_CMPST_RTN_B64
40	DS_MAX_RTN_U32	113	DS_CMPST_RTN_F64
41	DS_AND_RTN_B32	114	DS_MIN_RTN_F64
42	DS_OR_RTN_B32	115	DS_MAX_RTN_F64
43	DS_XOR_RTN_B32	118	DS_READ_B64
44	DS_MSKOR_RTN_B32	119	DS_READ2_B64
45	DS_WRXCHG_RTN_B32	120	DS_READ2ST64_B64
46	DS_WRXCHG2_RTN_B32	126	DS_CONDXCHG32_RTN_B64

Opcode #	Name	Opcode #	Name
47	DS_WRXCHG2ST64_RTN_B32	160	DS_WRITE_B8_D16_HI
48	DS_CMPST_RTN_B32	161	DS_WRITE_B16_D16_HI
49	DS_CMPST_RTN_F32	162	DS_READ_U8_D16
50	DS_MIN_RTN_F32	163	DS_READ_U8_D16_HI
51	DS_MAX_RTN_F32	164	DS_READ_I8_D16
52	DS_WRAP_RTN_B32	165	DS_READ_I8_D16_HI
53	DS_SWIZZLE_B32	166	DS_READ_U16_D16
54	DS_READ_B32	167	DS_READ_U16_D16_HI
55	DS_READ2_B32	176	DS_WRITE_ADDTID_B32
56	DS_READ2ST64_B32	177	DS_READ_ADDTID_B32
57	DS_READ_I8	178	DS_PERMUTE_B32
58	DS_READ_U8	179	DS_BPERMUTE_B32
59	DS_READ_I16	222	DS_WRITE_B96
60	DS_READ_U16	223	DS_WRITE_B128
61	DS_CONSUME	254	DS_READ_B96
62	DS_APPEND	255	DS_READ_B128
63	DS_ORDERED_COUNT		

## 13.6. Vector Memory Buffer Formats

There are two memory buffer instruction formats:

### MTBUF

typed buffer access (data type is defined by the instruction)

### MUBUF

untyped buffer access (data type is defined by the buffer / resource-constant)

### 13.6.1. MTBUF

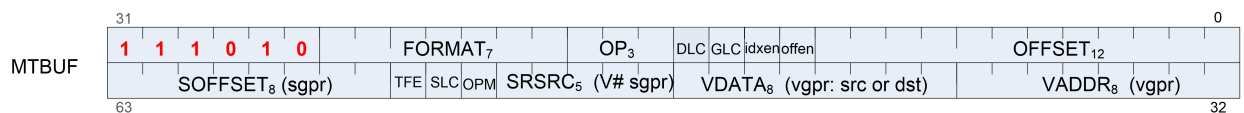

**Format** MTBUF



**Description** Memory Typed-Buffer Instructions

Table 96. MTBUF Fields

Field Name	Bits	Format or Description
OFFSET	[11:0]	Address offset, unsigned byte.
OFFEN	[12]	1 = enable offset VGPR, 0 = use zero for address offset
IDXEN	[13]	1 = enable index VGPR, 0 = use zero for address index
GLC	[14]	0 = normal, 1 = globally coherent (bypass L0 cache) or for atomics, return pre-op value to VGPR.
DLC	[15]	0 = normal, 1 = Device Coherent
OP	[53],[18:16]	Opcode. See table below. (combined bits 53 with 18-16 to form opcode)
DFMT	25:19	Data Format of data in memory buffer. See chapter 8 for encoding. <a href="#">Buffer Image format Table</a>
ENCODING	[31:26]	111010
VADDR	[39:32]	Address of VGPR to supply first component of address (offset or index). When both index and offset are used, index is in the first VGPR and offset in the second.
VDATA	[47:40]	Address of VGPR to supply first component of write data or receive first component of read-data.
SRSRC	[52:48]	SGPR to supply V# (resource constant) in 4 or 8 consecutive SGPRs. It is missing 2 LSB's of SGPR-address since it is aligned to 4 SGPRs.
SLC	[54]	System Level Coherent. Used in conjunction with DLC to determine L2 cache policies.
TFE	[55]	Partially resident texture, texture fail enable.
SOFFSET	[63:56]	Address offset, unsigned byte.

Table 97. MTBUF Opcodes

Opcode #	Name	Opcode #	Name
0	TBUFFER_LOAD_FORMAT_X	8	TBUFFER_LOAD_FORMAT_D16_X
1	TBUFFER_LOAD_FORMAT_XY	9	TBUFFER_LOAD_FORMAT_D16_XY
2	TBUFFER_LOAD_FORMAT_XYZ	10	TBUFFER_LOAD_FORMAT_D16_XYZ
3	TBUFFER_LOAD_FORMAT_XYZW	11	TBUFFER_LOAD_FORMAT_D16_XYZW
4	TBUFFER_STORE_FORMAT_X	12	TBUFFER_STORE_FORMAT_D16_X
5	TBUFFER_STORE_FORMAT_XY	13	TBUFFER_STORE_FORMAT_D16_XY
6	TBUFFER_STORE_FORMAT_XYZ	14	TBUFFER_STORE_FORMAT_D16_XYZ
7	TBUFFER_STORE_FORMAT_XYZW	15	TBUFFER_STORE_FORMAT_D16_XYZW

## 13.6.2. MUBUF

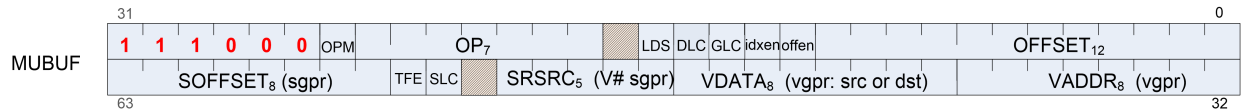

**Format** MUBUF

**Description** Memory Untyped-Buffer Instructions

Table 98. MUBUF Fields

Field Name	Bits	Format or Description
OFFSET	[11:0]	Address offset, unsigned byte.
OFFEN	[12]	1 = enable offset VGPR, 0 = use zero for address offset
IDXEN	[13]	1 = enable index VGPR, 0 = use zero for address index
GLC	[14]	0 = normal, 1 = globally coherent (bypass L0 cache) or for atomics, return pre-op value to VGPR.
DLC	[15]	0 = normal, 1 = Device Coherent
LDS	[16]	0 = normal, 1 = transfer data between LDS and memory instead of VGPRs and memory.
OP	[25:18]	Opcode. See table below.
ENCODING	[31:26]	111000
VADDR	[39:32]	Address of VGPR to supply first component of address (offset or index). When both index and offset are used, index is in the first VGPR and offset in the second.
VDATA	[47:40]	Address of VGPR to supply first component of write data or receive first component of read-data.
SRSRC	[52:48]	SGPR to supply V# (resource constant) in 4 or 8 consecutive SGPRs. It is missing 2 LSB's of SGPR-address since it is aligned to 4 SGPRs.
SLC	[54]	System Level Coherent. Used in conjunction with DLC to determine L2 cache policies.
TFE	[55]	Partially resident texture, texture fail enable.
SOFFSET	[63:56]	Address offset, unsigned byte.

Table 99. MUBUF Opcodes

Opcode #	Name	Opcode #	Name
0	BUFFER_LOAD_FORMAT_X	54	BUFFER_ATOMIC_UMIN
1	BUFFER_LOAD_FORMAT_XY	55	BUFFER_ATOMIC_SMAX
2	BUFFER_LOAD_FORMAT_XYZ	56	BUFFER_ATOMIC_UMAX
3	BUFFER_LOAD_FORMAT_XYZW	57	BUFFER_ATOMIC_AND

Opcode #	Name	Opcode #	Name
4	BUFFER_STORE_FORMAT_X	58	BUFFER_ATOMIC_OR
5	BUFFER_STORE_FORMAT_XY	59	BUFFER_ATOMIC_XOR
6	BUFFER_STORE_FORMAT_XYZ	60	BUFFER_ATOMIC_INC
7	BUFFER_STORE_FORMAT_XYZW	61	BUFFER_ATOMIC_DEC
8	BUFFER_LOAD_UBYTE	62	BUFFER_ATOMIC_FCMP_SWAP
9	BUFFER_LOAD_SBYTE	63	BUFFER_ATOMIC_FMIN
10	BUFFER_LOAD_USHORT	64	BUFFER_ATOMIC_FMAX
11	BUFFER_LOAD_SSHORT	80	BUFFER_ATOMIC_SWAP_X2
12	BUFFER_LOAD_DWORD	81	BUFFER_ATOMIC_CMP_SWAP_X2
13	BUFFER_LOAD_DWORDX2	82	BUFFER_ATOMIC_ADD_X2
14	BUFFER_LOAD_DWORDX4	83	BUFFER_ATOMIC_SUB_X2
15	BUFFER_LOAD_DWORDX3	85	BUFFER_ATOMIC_SMIN_X2
24	BUFFER_STORE_BYTE	86	BUFFER_ATOMIC_UMIN_X2
25	BUFFER_STORE_BYTE_D16_HI	87	BUFFER_ATOMIC_SMAX_X2
26	BUFFER_STORE_SHORT	88	BUFFER_ATOMIC_UMAX_X2
27	BUFFER_STORE_SHORT_D16_HI	89	BUFFER_ATOMIC_AND_X2
28	BUFFER_STORE_DWORD	90	BUFFER_ATOMIC_OR_X2
29	BUFFER_STORE_DWORDX2	91	BUFFER_ATOMIC_XOR_X2
30	BUFFER_STORE_DWORDX4	92	BUFFER_ATOMIC_INC_X2
31	BUFFER_STORE_DWORDX3	93	BUFFER_ATOMIC_DEC_X2
32	BUFFER_LOAD_UBYTE_D16	94	BUFFER_ATOMIC_FCMP_SWAP_X2
33	BUFFER_LOAD_UBYTE_D16_HI	95	BUFFER_ATOMIC_FMIN_X2
34	BUFFER_LOAD_SBYTE_D16	96	BUFFER_ATOMIC_FMAX_X2
35	BUFFER_LOAD_SBYTE_D16_HI	113	BUFFER_GL0_INV
36	BUFFER_LOAD_SHORT_D16	114	BUFFER_GL1_INV
37	BUFFER_LOAD_SHORT_D16_HI	128	BUFFER_LOAD_FORMAT_D16_X
38	BUFFER_LOAD_FORMAT_D16_HI_X	129	BUFFER_LOAD_FORMAT_D16_XY
39	BUFFER_STORE_FORMAT_D16_HI_X	130	BUFFER_LOAD_FORMAT_D16_XYZ
48	BUFFER_ATOMIC_SWAP	131	BUFFER_LOAD_FORMAT_D16_XYZW
49	BUFFER_ATOMIC_CMP_SWAP	132	BUFFER_STORE_FORMAT_D16_X
50	BUFFER_ATOMIC_ADD	133	BUFFER_STORE_FORMAT_D16_XY
51	BUFFER_ATOMIC_SUB	134	BUFFER_STORE_FORMAT_D16_XYZ
52	BUFFER_ATOMIC_CSUB	135	BUFFER_STORE_FORMAT_D16_XYZW
53	BUFFER_ATOMIC_SMIN		

# 13.7. Vector Memory Image Format

## 13.7.1. MIMG

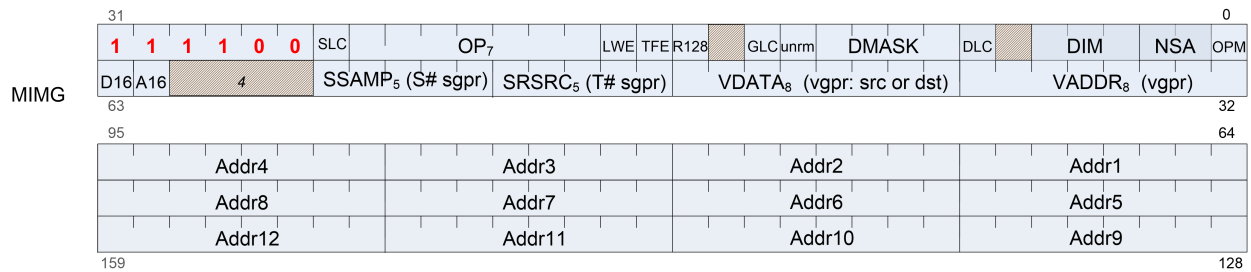

**Format** MIMG

**Description** Memory Image Instructions

Memory Image instructions (MIMG format) can be between 2 and 5 dwords. There are two variations of the instruction:

- Normal, where the address VGPRs are specified in the "ADDR" field, and are a contiguous set of VGPRs. This is a 2-dword instruction.
- Non-Sequential-Address (NSA), where each address VGPR is specified individually and the address VGPRs can be scattered. This version uses 1-3 extra dwords to specify the individual address VGPRs.

Table 100. MIMG Fields

Field Name	Bits	Format or Description
NSA	[2:1]	Non-sequential address. Specifies how many additional instruction dwords exist (0-3).
DIM	[5:3]	Dimensionality of the resource constant. Set to bits [3:1] of the resource type field.
DLC	[7]	0 = normal, 1 = Device Coherent
DMASK	[11:8]	Data VGPR enable mask: 1 .. 4 consecutive VGPRs Reads: defines which components are returned: 0=red,1=green,2=blue,3=alpha Writes: defines which components are written with data from VGPRs (missing components get 0). Enabled components come from consecutive VGPRs. E.G. dmask=1001 : Red is in VGPRn and alpha in VGPRn+1. For D16 writes, DMASK is only used as a word count: each bit represents 16 bits of data to be written starting at the LSB's of VDATA, then MSBs, then VDATA+1 etc. Bit position is ignored.
UNRM	[12]	Force address to be un-normalized. User must set to 1 for Image stores & atomics.

Field Name	Bits	Format or Description
GLC	[13]	0 = normal, 1 = globally coherent (bypass L0 cache) or for atomics, return pre-op value to VGPR.
R128	[15]	Resource constant size: 1 = 128bit, 0 = 256bit
TFE	[16]	Partially resident texture, texture fail enable.
LWE	[17]	LOD Warning Enable. When set to 1, a texture fetch may return "LOD_CLAMPED = 1".
OP	[0],[24:18]	Opcode. See table below. (combine bits zero and 18-24 to form opcode).
SLC	[25]	System Level Coherent. Used in conjunction with DLC to determine L2 cache policies.
ENCODING	[31:26]	111100
VADDR	[39:32]	Address of VGPR to supply first component of address (offset or index). When both index and offset are used, index is in the first VGPR and offset in the second.
VDATA	[47:40]	Address of VGPR to supply first component of write data or receive first component of read-data.
SRSRC	[52:48]	SGPR to supply V# (resource constant) in 4 or 8 consecutive SGPRs. It is missing 2 LSB's of SGPR-address since it is aligned to 4 SGPRs.
SSAMP	[57:53]	SGPR to supply V# (resource constant) in 4 or 8 consecutive SGPRs. It is missing 2 LSB's of SGPR-address since it is aligned to 4 SGPRs.
A16	[62]	Address components are 16-bits (instead of the usual 32 bits). When set, all address components are 16 bits (packed into 2 per dword), except: Texel offsets (3 6bit UINT packed into 1 dword) PCF reference (for "_C" instructions) Address components are 16b uint for image ops without sampler; 16b float with sampler.
D16	[63]	Address offset, unsigned byte.

Table 101. MIMG Opcodes

Opcode #	Name	Opcode #	Name
0	IMAGE_LOAD	53	IMAGE_SAMPLE_B_O
1	IMAGE_LOAD_MIP	54	IMAGE_SAMPLE_B_CL_O
2	IMAGE_LOAD_PCK	55	IMAGE_SAMPLE_LZ_O
3	IMAGE_LOAD_PCK_SGN	56	IMAGE_SAMPLE_C_O
4	IMAGE_LOAD_MIP_PCK	57	IMAGE_SAMPLE_C_CL_O
5	IMAGE_LOAD_MIP_PCK_SGN	58	IMAGE_SAMPLE_C_D_O
8	IMAGE_STORE	59	IMAGE_SAMPLE_C_D_CL_O
9	IMAGE_STORE_MIP	60	IMAGE_SAMPLE_C_L_O
10	IMAGE_STORE_PCK	61	IMAGE_SAMPLE_C_B_O

Opcode #	Name	Opcode #	Name
11	IMAGE_STORE_MIP_PCK	62	IMAGE_SAMPLE_C_B_CL_O
14	IMAGE_GET_RESINFO	63	IMAGE_SAMPLE_C_LZ_O
15	IMAGE_ATOMIC_SWAP	64	IMAGE_GATHER4
16	IMAGE_ATOMIC_CMPSWAP	65	IMAGE_GATHER4_CL
17	IMAGE_ATOMIC_ADD	68	IMAGE_GATHER4_L
18	IMAGE_ATOMIC_SUB	69	IMAGE_GATHER4_B
20	IMAGE_ATOMIC_SMIN	70	IMAGE_GATHER4_B_CL
21	IMAGE_ATOMIC_UMIN	71	IMAGE_GATHER4_LZ
22	IMAGE_ATOMIC_SMAX	72	IMAGE_GATHER4_C
23	IMAGE_ATOMIC_UMAX	73	IMAGE_GATHER4_C_CL
24	IMAGE_ATOMIC_AND	76	IMAGE_GATHER4_C_L
25	IMAGE_ATOMIC_OR	77	IMAGE_GATHER4_C_B
26	IMAGE_ATOMIC_XOR	78	IMAGE_GATHER4_C_B_CL
27	IMAGE_ATOMIC_INC	79	IMAGE_GATHER4_C_LZ
28	IMAGE_ATOMIC_DEC	80	IMAGE_GATHER4_O
29	IMAGE_ATOMIC_FCMPSWAP	81	IMAGE_GATHER4_CL_O
30	IMAGE_ATOMIC_FMIN	84	IMAGE_GATHER4_L_O
31	IMAGE_ATOMIC_FMAX	85	IMAGE_GATHER4_B_O
32	IMAGE_SAMPLE	86	IMAGE_GATHER4_B_CL_O
33	IMAGE_SAMPLE_CL	87	IMAGE_GATHER4_LZ_O
34	IMAGE_SAMPLE_D	88	IMAGE_GATHER4_C_O
35	IMAGE_SAMPLE_D_CL	89	IMAGE_GATHER4_C_CL_O
36	IMAGE_SAMPLE_L	92	IMAGE_GATHER4_C_L_O
37	IMAGE_SAMPLE_B	93	IMAGE_GATHER4_C_B_O
38	IMAGE_SAMPLE_B_CL	94	IMAGE_GATHER4_C_B_CL_O
39	IMAGE_SAMPLE_LZ	95	IMAGE_GATHER4_C_LZ_O
40	IMAGE_SAMPLE_C	96	IMAGE_GET_LOD
41	IMAGE_SAMPLE_C_CL	97	IMAGE_GATHER4H
42	IMAGE_SAMPLE_C_D	128	IMAGE_MSAA_LOAD
43	IMAGE_SAMPLE_C_D_CL	162	IMAGE_SAMPLE_D_G16
44	IMAGE_SAMPLE_C_L	163	IMAGE_SAMPLE_D_CL_G16
45	IMAGE_SAMPLE_C_B	170	IMAGE_SAMPLE_C_D_G16
46	IMAGE_SAMPLE_C_B_CL	171	IMAGE_SAMPLE_C_D_CL_G16
47	IMAGE_SAMPLE_C_LZ	178	IMAGE_SAMPLE_D_O_G16

Opcode #	Name	Opcode #	Name
48	IMAGE_SAMPLE_O	179	IMAGE_SAMPLE_D_CL_O_G16
49	IMAGE_SAMPLE_CL_O	186	IMAGE_SAMPLE_C_D_O_G16
50	IMAGE_SAMPLE_D_O	187	IMAGE_SAMPLE_C_D_CL_O_G16
51	IMAGE_SAMPLE_D_CL_O	230	IMAGE_BVH_INTERSECT_RAY
52	IMAGE_SAMPLE_L_O	231	IMAGE_BVH64_INTERSECT_RAY

## 13.8. Flat Formats

Flat memory instruction come in three versions: FLAT:: memory address (per work-item) may be in global memory, scratch (private) memory or shared memory (LDS) GLOBAL:: same as FLAT, but assumes all memory addresses are global memory. SCRATCH:: same as FLAT, but assumes all memory addresses are scratch (private) memory.

The microcode format is identical for each, and only the value of the SEG (segment) field differs.

### 13.8.1. FLAT

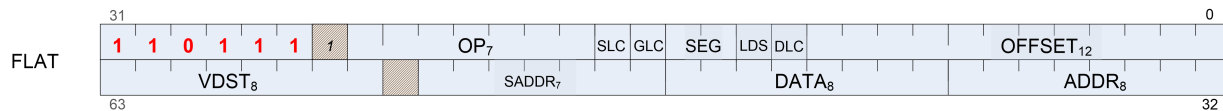

**Format** FLAT

**Description** FLAT Memory Access

Table 102. FLAT Fields

Field Name	Bits	Format or Description
OFFSET	[11:0]	Address offset Scratch, Global: 12-bit signed byte offset FLAT: 11-bit unsigned offset (MSB is ignored)
DLC	[12]	0 = normal, 1 = Device Coherent
LDS	[13]	0 = normal, 1 = transfer data between LDS and memory instead of VGPRs and memory.
SEG	[15:14]	Memory Segment (instruction type): 0 = flat, 1 = scratch, 2 = global.
GLC	[16]	0 = normal, 1 = globally coherent (bypass L0 cache) or for atomics, return pre-op value to VGPR.
SLC	[17]	System Level Coherent. Used in conjunction with DLC to determine L2 cache policies.

Field Name	Bits	Format or Description
OP	[24:18]	Opcode. See tables below for FLAT, SCRATCH and GLOBAL opcodes.
ENCODING	[31:26]	110111
ADDR	[39:32]	VGPR which holds address or offset. For 64-bit addresses, ADDR has the LSB's and ADDR+1 has the MSBs. For offset a single VGPR has a 32 bit unsigned offset. For FLAT_*: specifies an address. For GLOBAL_* and SCRATCH_* when SADDR is NULL or 0x7f: specifies an address. For GLOBAL_* and SCRATCH_* when SADDR is not NULL or 0x7f: specifies an offset.
DATA	[47:40]	VGPR which supplies data.
SADDR	[54:48]	Scalar SGPR which provides an address of offset (unsigned). Set this field to NULL or 0x7f to disable use. Meaning of this field is different for Scratch and Global: FLAT: Unused Scratch: use an SGPR for the address instead of a VGPR Global: use the SGPR to provide a base address and the VGPR provides a 32-bit byte offset.
VDST	[63:56]	Destination VGPR for data returned from memory to VGPRs.

Table 103. FLAT Opcodes

Opcode #	Name	Opcode #	Name
8	FLAT_LOAD_UBYTE	54	FLAT_ATOMIC_UMIN
9	FLAT_LOAD_SBYTE	55	FLAT_ATOMIC_SMAX
10	FLAT_LOAD_USHORT	56	FLAT_ATOMIC_UMAX
11	FLAT_LOAD_SSHORT	57	FLAT_ATOMIC_AND
12	FLAT_LOAD_DWORD	58	FLAT_ATOMIC_OR
13	FLAT_LOAD_DWORDX2	59	FLAT_ATOMIC_XOR
14	FLAT_LOAD_DWORDX4	60	FLAT_ATOMIC_INC
15	FLAT_LOAD_DWORDX3	61	FLAT_ATOMIC_DEC
24	FLAT_STORE_BYTE	62	FLAT_ATOMIC_FCMP_SWAP
25	FLAT_STORE_BYTE_D16_HI	63	FLAT_ATOMIC_FMIN
26	FLAT_STORE_SHORT	64	FLAT_ATOMIC_FMAX
27	FLAT_STORE_SHORT_D16_HI	80	FLAT_ATOMIC_SWAP_X2
28	FLAT_STORE_DWORD	81	FLAT_ATOMIC_CMP_SWAP_X2
29	FLAT_STORE_DWORDX2	82	FLAT_ATOMIC_ADD_X2
30	FLAT_STORE_DWORDX4	83	FLAT_ATOMIC_SUB_X2
31	FLAT_STORE_DWORDX3	85	FLAT_ATOMIC_SMIN_X2
32	FLAT_LOAD_UBYTE_D16	86	FLAT_ATOMIC_UMIN_X2



Opcode #	Name	Opcode #	Name
33	FLAT_LOAD_UBYTE_D16_HI	87	FLAT_ATOMIC_SMAX_X2
34	FLAT_LOAD_SBYTE_D16	88	FLAT_ATOMIC_UMAX_X2
35	FLAT_LOAD_SBYTE_D16_HI	89	FLAT_ATOMIC_AND_X2
36	FLAT_LOAD_SHORT_D16	90	FLAT_ATOMIC_OR_X2
37	FLAT_LOAD_SHORT_D16_HI	91	FLAT_ATOMIC_XOR_X2
48	FLAT_ATOMIC_SWAP	92	FLAT_ATOMIC_INC_X2
49	FLAT_ATOMIC_CMPSWAP	93	FLAT_ATOMIC_DEC_X2
50	FLAT_ATOMIC_ADD	94	FLAT_ATOMIC_FCMP_SWAP_X2
51	FLAT_ATOMIC_SUB	95	FLAT_ATOMIC_FMIN_X2
53	FLAT_ATOMIC_SMIN	96	FLAT_ATOMIC_FMAX_X2

## 13.8.2. GLOBAL

Table 104. GLOBAL Opcodes

Opcode #	Name	Opcode #	Name
8	GLOBAL_LOAD_UBYTE	53	GLOBAL_ATOMIC_SMIN
9	GLOBAL_LOAD_SBYTE	54	GLOBAL_ATOMIC_UMIN
10	GLOBAL_LOAD_USHORT	55	GLOBAL_ATOMIC_SMAX
11	GLOBAL_LOAD_SSHORT	56	GLOBAL_ATOMIC_UMAX
12	GLOBAL_LOAD_DWORD	57	GLOBAL_ATOMIC_AND
13	GLOBAL_LOAD_DWORDX2	58	GLOBAL_ATOMIC_OR
14	GLOBAL_LOAD_DWORDX4	59	GLOBAL_ATOMIC_XOR
15	GLOBAL_LOAD_DWORDX3	60	GLOBAL_ATOMIC_INC
22	GLOBAL_LOAD_DWORD_ADDTID	61	GLOBAL_ATOMIC_DEC
23	GLOBAL_STORE_DWORD_ADDTID	62	GLOBAL_ATOMIC_FCMP_SWAP
24	GLOBAL_STORE_BYTE	63	GLOBAL_ATOMIC_FMIN
25	GLOBAL_STORE_BYTE_D16_HI	64	GLOBAL_ATOMIC_FMAX
26	GLOBAL_STORE_SHORT	80	GLOBAL_ATOMIC_SWAP_X2
27	GLOBAL_STORE_SHORT_D16_HI	81	GLOBAL_ATOMIC_CMPSWAP_X2
28	GLOBAL_STORE_DWORD	82	GLOBAL_ATOMIC_ADD_X2
29	GLOBAL_STORE_DWORDX2	83	GLOBAL_ATOMIC_SUB_X2
30	GLOBAL_STORE_DWORDX4	85	GLOBAL_ATOMIC_SMIN_X2
31	GLOBAL_STORE_DWORDX3	86	GLOBAL_ATOMIC_UMIN_X2
32	GLOBAL_LOAD_UBYTE_D16	87	GLOBAL_ATOMIC_SMAX_X2

Opcode #	Name	Opcode #	Name
33	GLOBAL_LOAD_UBYTE_D16_HI	88	GLOBAL_ATOMIC_UMAX_X2
34	GLOBAL_LOAD_SBYTE_D16	89	GLOBAL_ATOMIC_AND_X2
35	GLOBAL_LOAD_SBYTE_D16_HI	90	GLOBAL_ATOMIC_OR_X2
36	GLOBAL_LOAD_SHORT_D16	91	GLOBAL_ATOMIC_XOR_X2
37	GLOBAL_LOAD_SHORT_D16_HI	92	GLOBAL_ATOMIC_INC_X2
48	GLOBAL_ATOMIC_SWAP	93	GLOBAL_ATOMIC_DEC_X2
49	GLOBAL_ATOMIC_CMPSWAP	94	GLOBAL_ATOMIC_FCMPSWAP_X2
50	GLOBAL_ATOMIC_ADD	95	GLOBAL_ATOMIC_FMIN_X2
51	GLOBAL_ATOMIC_SUB	96	GLOBAL_ATOMIC_FMAX_X2
52	GLOBAL_ATOMIC_CSUB		

### 13.8.3. SCRATCH

Table 105. SCRATCH Opcodes

Opcode #	Name	Opcode #	Name
8	SCRATCH_LOAD_UBYTE	27	SCRATCH_STORE_SHORT_D16_HI
9	SCRATCH_LOAD_SBYTE	28	SCRATCH_STORE_DWORD
10	SCRATCH_LOAD_USHORT	29	SCRATCH_STORE_DWORDX2
11	SCRATCH_LOAD_SSHORT	30	SCRATCH_STORE_DWORDX4
12	SCRATCH_LOAD_DWORD	31	SCRATCH_STORE_DWORDX3
13	SCRATCH_LOAD_DWORDX2	32	SCRATCH_LOAD_UBYTE_D16
14	SCRATCH_LOAD_DWORDX4	33	SCRATCH_LOAD_UBYTE_D16_HI
15	SCRATCH_LOAD_DWORDX3	34	SCRATCH_LOAD_SBYTE_D16
24	SCRATCH_STORE_BYTE	35	SCRATCH_LOAD_SBYTE_D16_HI
25	SCRATCH_STORE_BYTE_D16_HI	36	SCRATCH_LOAD_SHORT_D16
26	SCRATCH_STORE_SHORT	37	SCRATCH_LOAD_SHORT_D16_HI

## 13.9. Export Format

### 13.9.1. EXP

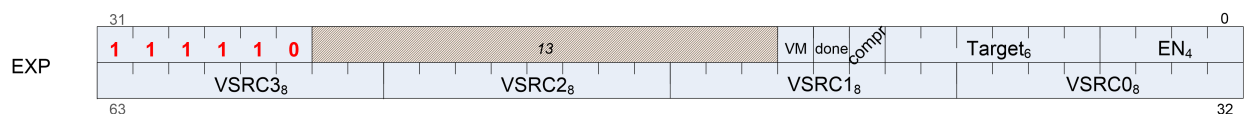

**Format**        EXP

**Description**    EXPORT instructions

The export format has only a single opcode, "EXPORT".

*Table 106. EXP Fields*

Field Name	Bits	Format or Description
EN	[3:0]	COMPR==1: export half-dword enable. Valid values are: 0x0,3,c,f [0] enables VSRC0 : R,G from one VGPR (R in low bits, G high) [2] enables VSRC1 : B,A from one VGPR (B in low bits, A high) COMPR==0: [0-3] = enables for VSRC0..3. EN may be zero only for "NULL Pixel Shader" exports (used when exporting only valid mask to NULL target).
TARGET	[9:4]	Export destination: 0-7: MRT 0..7 8: Z 9: Null pixel shader export (no data) 12-15: Position 0..3 20: Primitive data 32-63: Parameter 0..31
COMPR	[10]	Indicates that data is float-16/short/byte (compressed). Data is written to consecutive components (rgba or xyzw).
DONE	[11]	Indicates that this is the last export from the shader. Used only for Position and Pixel/color data.
VM	[12]	1 = the exec mask IS the valid mask for this export. Can be sent multiple times, but user must send at least once per pixel shader. This bit is only used for Pixel Shaders.
ENCODING	[31:26]	111110
VSRC0	[39:32]	VGPR for source 0.
VSRC1	[47:40]	VGPR for source 1.
VSRC2	[55:48]	VGPR for source 2.
VSRC3	[63:56]	VGPR for source 3.